



Defense
and Aerospace

KEMET
CHARGED.™

Ceramic High Reliability Capacitors

	KEMET Series	Page
MIL-PRF-123 Performance Information		1-3
MIL-PRF-123/01/02/03	C052Z/C062Z/C512Z	4-7
MIL-PRF-123/10/11/12/13/ 21/22/23	C0805Z/C1206/C1210Z/ C1808Z/C1812Z/C1825Z/C2225Z	4, 8-11
GR900 Performance Information		12
GR900 High Reliability Radial	C052B/C062B/C512B	13-16
GR900 High Reliability Chips	C0805A/C1005A/C1206A/ C1210A/C1805A/C1808A/ C1812A/C1825A/C2225	17-23

CERAMIC HIGH RELIABILITY PRODUCTS

Ceramic Chips, Radial Molded

KEMET Electronics Corporation has been known for many years as the leader in the ceramic high reliability products. KEMET produces high reliability monolithic ceramic capacitors under tightly-controlled manufacturing procedures. These capacitors achieve “State of the Art” performance by virtue of careful materials selection, conservative design rules, motivational training of employees, and scrupulous inspection of all processes as well as the finished product. KEMET not only manufactures its own high reliability ceramic capacitor (GR900), KEMET also manufactures MIL-PRF-123 product which is built to the highest military standard in the industry today.

BASIC REQUIREMENTS FOR KEMET’S HIGH RELIABILITY PRODUCTS ARE AS FOLLOWS:

- 1. Selected Raw Materials:** All raw materials are selected for characteristics known to produce the finest quality capacitors exhibiting the best electrical parameters and physical integrity. Materials traceability is maintained throughout the manufacturing process.
- 2. Batch Homogeneity:** Production is under batch control. Each batch is homogeneous with respect to materials, design and processing conditions.
- 3. Clean Room Processing:** All processes sensitive to particulate contamination take place in a clean room environment.
- 4. Special Designs:** Special design considerations such as dielectric thickness are strictly enforced. Only COG (BP) and X7R (BX) temperature characteristics are made.
- 5. Destructive Physical Analysis (DPA, or Cross-Sectioning):** All batches are sampled using EIA-469 as a minimum requirement. The samples remain on file and DPA Reports are shipped with the capacitors.
- 6. Ultrasonic Scanning:** Optional 100% screening may be performed using ultrasonic waves to detect voids or delaminations. Screened lots must pass a final sample DPA.
- 7. Batch Performance Monitoring:** All production batches are tested to generate electrical characteristics. Batches which show anomalous characteristics are rejected.
- 8. Special Customer Requirements:** Many special requirements such as serialization, DPA samples,

X-Ray plates, and special packaging can be accommodated.

9. Document Applicable: The high reliability product is implemented through various internal documents under revision control. The Manufacturing Instructions provide detailed descriptions of all operations and delineate requirements for process control and product performance at various points in the process flow. Inspector Operating Documents describe test procedures and sampling plans for inspection of raw materials, in-process material and finished product. Raw material specifications describe physical and chemical characteristics as well as the packaging and labeling needed to preserve characteristics and identity. Customer specifications are internal documents applicable only to products manufactured and inspected to requirements of individual customers; in effect, these documents translate customer drawings into modifications of the specified portions of KEMET standard procedures.

The Quality System in total is controlled by the KEMET Quality Manual and by various Quality Operating Documents. All documents, and revisions thereto, bear specified approval signatures.

DETAILED SPECIFICATION: Temperature Characteristics

Electrical stability with respect to temperature and voltage is related inversely to the packaging efficiency (capacitance X voltage in a given case size). COG (BP) is made from ceramic materials which are not ferroelectric, yielding superior stability but low packaging efficiency. X7R (BX) is made from materials which are ferroelectric, such as barium titanate, yielding a stable and high packaging efficiency.

Aging

If the temperature of a barium titanate dielectric is lowered after an excursion above its curie point, the ceramic crystalline structure gradually reverts to the tetragonal form typical of the low temperature conditions. The reversion requires a considerable length of time, and its effect in practical capacitors has become known as “Aging”. The rate of aging is affected by both the temperature and the applied voltage experienced by the capacitor. The COG (BP) formulation is non-ferroelectric and does not exhibit aging. The X7R (BX) formulation exhibits its own

characteristic aging rate which describes a decrease in capacitance versus time. The capacitance of the X7R dielectric decreases approximately 1.0% during each decade of hours following a return to temperatures below the curie point. In other words, capacitance will decrease 1.0% between 1 and 10 hours, another 1.0% between 10 and 100 hours, another 1.0% between 100 and 1000 hours, etc.

KEMET takes into consideration the aging rate by designing capacitors to fall within the specified capacitance tolerance at 1000 hours. Inasmuch as the aging rate is exponential, very little change in capacitance will take place after 1000 hours.

Voltage Effects

Ferroelectric materials are also affected by applied voltage, both alternating and direct. Low values of voltage produce a slight increase in capacitance and dissipation factor. Higher voltages cause a decrease in capacitance. Typically, capacitors with X7R characteristic decrease in capacitance by approximately 10% when rated DC voltage is applied.

A small portion of the decrease in capacitance by the application of a high DC voltage persists after the voltage is removed and then disappears gradually.

Customer Testing

Because of temperature and voltage effects, caution must be used in establishing a testing sequence for ceramic capacitors. Insulation resistance measurements and tests of dielectric withstanding voltage both require application of high DC voltage and cause temporary changes in capacitance. These tests, therefore, should not be conducted until capacitance testing is completed. Alternatively, the capacitors can be "de-aged" at high temperature as described above. A stabilization time at room ambient of 24 hours should be used after de-aging.

See F-3101 Catalog for more details.

PERFORMANCE CHARACTERISTICS

General Information

Working Voltage:

COG (BP) - 50,100 & 200 volts

X7R (BX) - 50,100 & 200 volts

Temperature Characteristics:

COG (BP): 0 ± 30 ppm/C from -55°C to +125°C.
(Limits widen below 20 pF.)

X7R (BX): $\pm 15\%$; from -55°C to +125°C.

Capacitance Tolerance:

COG (BP): C - ± 0.25 pF; D - ± 0.5 pF; F - $\pm 1\%$;
G- $\pm 2\%$; J- $\pm 5\%$; K- $\pm 10\%$; M- $\pm 20\%$.

X7R (BX): J - $\pm 5\%$; K - $\pm 10\%$; M - $\pm 20\%$.

Electrical

Capacitance: Within specified tolerance when measured with 1 volt RMS @ 1 kHz (1000pF or less @ 1 MHz for COG (BP)).

Dissipation Factor:

25°C @ 1 kHz (1000 pF or less at 1 MHz for COG (BP)).

COG (BP): 0.15% maximum

X7R (BX): 2.5% maximum

Insulation Resistance:

After 2 minutes electrification:

at 25°C and rated voltage:

COG (BP): 100K megohms or (1000 megohm X μ F), whichever is less.

X7R (BX): 100K megohms or (1000 megohm X μ F), whichever is less.

at 125°C and rated voltage:

COG (BP): 10K megohms or (100 megohm X μ F), whichever is less.

X7R (BX): 10K megohms or (100 megohm X μ F), whichever is less.

Dielectric Withstanding Voltage: 250% of rated voltage for 5 seconds with current limited to 50 MA at 25°C.

Aging Rate: % Delta Cap/Decade Hour, Typical

COG (BP): 0%

X7R (BX): 1.0%

**MIL-PRF-123/GR900
TYPICAL PERFORMANCE CURVES**

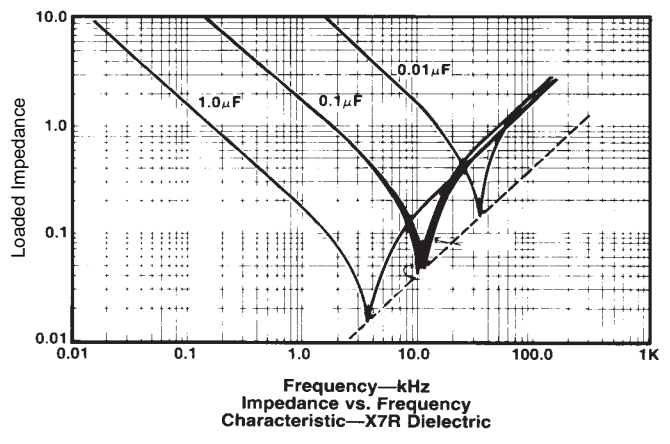
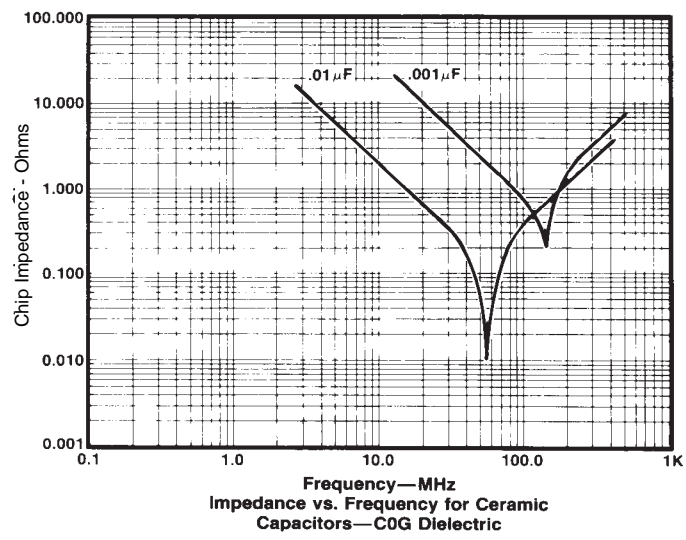
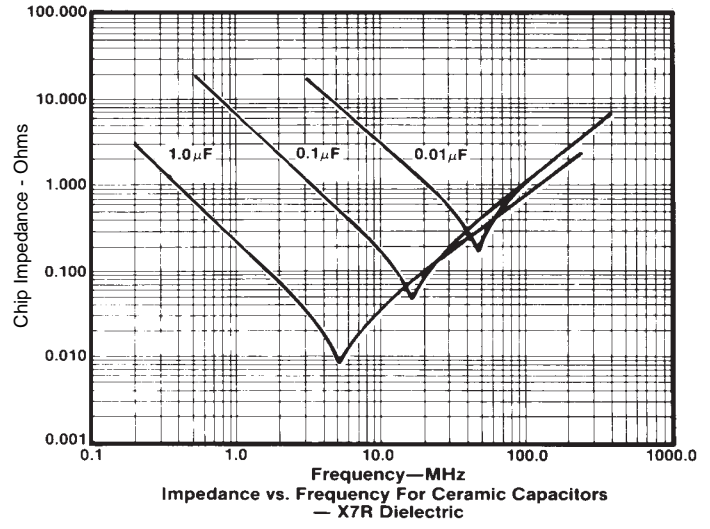
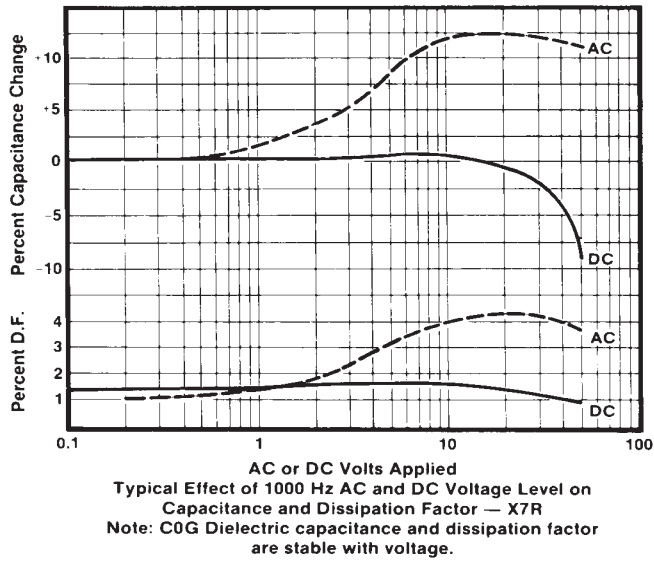
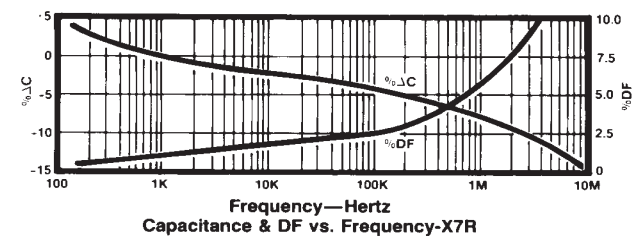
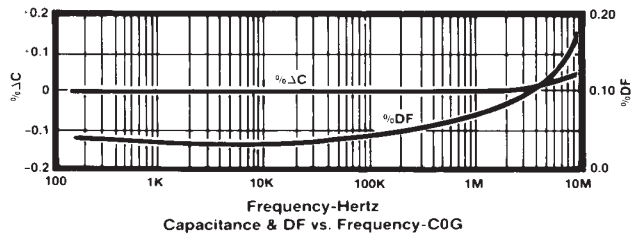
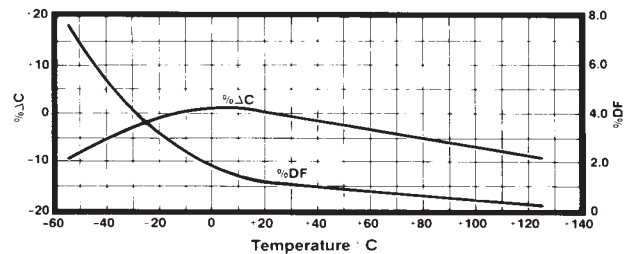
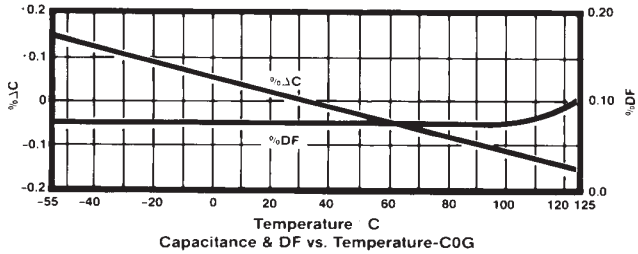

INTRODUCTION

MIL-PRF-123 specification covers the general requirements for high reliability, general purpose (BX) and temperature stable (BP) ceramic dielectric fixed capacitors for space, missile, and other high reliability applications. Capacitors covered by MIL-PRF-123 may be used in critical frequency determining applications, timing circuits, and other applications where absolute stability is required (BP) and in applications where appreciable variations in capacitance with respect to temperature, voltage, frequency, and life can be tolerated (BX).

SCREENING TESTS

Each lot has the following In-Process Inspections performed:

- 100% Ultrasonic Scan
- In-Process Destructive Physical Analysis
- 100% visual inspection at a minimum of 10X magnification
- Pre-encapsulation terminal strength evaluation (leaded devices only). Radial leaded capacitors must meet a minimum lead pull of 1.8 kg (4.0 lbs.).

The following Group A shall be performed on each lot:

- Thermal Shock**—Performed in accordance to MIL-STD-202, Method 107, Condition A, with step 3 being 125°C. Number of cycles shall be 20 (100% of lot).
- Voltage Conditioning**—The voltage conditioning shall consist of applying twice the rated voltage to the units at the maximum rated temperature of 125°C for a minimum of 168 hours and a maximum of 264 hours. The voltage conditioning may be terminated at any time during 168 hours to 264 hours time interval that confirmed failures meet the requirements for the PDA during the last 48 hours listed in Table I below (100% of lot).

Optional Voltage Conditioning (Accelerated Voltage Conditioning)—All conditions of the standard voltage conditioning apply with the exception of the increased voltage and the decreased test time. (Refer to Mil-PRF-123 for formula.)

- *Step 5 is performed on chips at this point (100% of lot).
- Dielectric Withstanding Voltage** 250% of the dc rated voltage at 25°C (100% of lot).
- Insulation Resistance**—The 25°C measurement with rated voltage applied shall be the lesser of 100,000 megohms or 1000 megohm-microfarads (100% of lot).
- *5. **Insulation Resistance**—The 125°C measurement with rated voltage applied shall be the lesser of 10,000 megohms or 100 megohm-microfarads (1000% of lot). For chips 125°C IR is performed prior to step 3 above.
- Storage** at 150°C for 2 hours minimum without voltage applied followed by a 12-hour minimum stabilization period (temperature characteristic BX only).
- Capacitance** must be within specified tolerance at 25°C (100% of lot). **Cap Exclusion:** Capacitance values no more than 5% or .5 pF, whichever is greater, for BX characteristics or 1% or .3 pF, whichever is greater, for BP characteristics beyond specified tolerance limit shall be removed from the lot but shall not be considered defective for determination of the PDA.
- Dissipation Factor** shall not exceed 2.5% for X dielectric, 0.15% for G dielectric at 25°C (100% of lot).
- Percent Defective Allowable (PDA).** The following table lists the PDA requirements for MIL-PRF-123 Group A:

TABLE I

KEMET STYLE	MIL STYLE	BURN IN PDA LAST 48 HOURS	PDA OVERALL
C052Z	CKS05	1 unit or 0.1%	3%
C062Z	CKS06	1 unit or 0.2%	5%
C512Z	CKS07	1 unit or 0.2%	5%
C0805Z	CKS51	1 unit or 0.1%	3%
C1206Z	CKS55	1 unit or 0.1%	3%
C1210Z	CKS52	1 unit or 0.1%	3%
C1808Z	CKS53	1 unit or 0.1%	3%
C1812Z	CKS56	1 unit or 0.1%	3%
C1825Z	CKS57	1 unit or 0.1%	3%
C2225Z	CKS54	1 unit or 0.1%	3%

- Radiographic Inspection** (leaded devices only) (100% of lot).
- Visual Inspection** per MIL-PRF-123 criteria.
- Destructive Physical Analysis** per EIA-469 and MIL-PRF-123.

SAMPLE TESTS

The following Group B tests shall be performed on samples from each lot, which have been subjected to and have passed Group A inspection.

- Thermal Shock**—Performed in accordance to MIL-STD-202, Method 107, Condition A, with step 3 being 125°C. Number of cycles shall be 100.
- Life Test per MIL-5TD-202, Method 108.** Test temperature and tolerance is +125°C +4°, -0°C. Capacitors shall be subjected to 2X rated voltage for 1000 hours.
- Humidity, steady state, low voltage per MIL-STD-202, Method 103, Condition A.** Capacitors shall be subjected to an environment of 85°C with 85% relative humidity for 240 hours minimum. Cycling shall not be performed. A dc potential of 1.3 ±0.25 volts shall be applied continuously through a 100,000 ohm resistance to each device under test. At completion, 25°C IR and Cap are read.
- Voltage-temperature limits**—Capacitance is measured at various temperatures (-55°C to +125°C) with and without rated voltage.
- Moisture Resistance per MIL-STD-202, Method 106.** There shall be 20 continuous cycles. During the first 10 cycles only, a dc potential of 50 volts shall be applied across the capacitor terminals. Once each day, a check shall be performed to determine whether a capacitor has shorted. Vibration cycle of MIL-STD-202, Method 106, Step 7b shall not be performed. Upon completion of MIL-STD-202, Method 106, Step 6 of the final cycle, capacitors shall be measured for capacitance, dielectric withstanding voltage and insulation resistance.

The following Group C tests shall be performed on samples selected from lots that have passed Group A and have been submitted for Group B inspection. Samples shall be selected every two months.

- Terminal Strength
- Solderability
- Resistance to Soldering Heat
- Solvent Resistance (Leaded devices only)

All lots shipped must have been subjected to and passed Group A and B testing.

STANDARD PACKAGING FOR MIL-PRF-123 IS AS FOLLOWS:

C052Z	tray	C0805Z	chip tray
		C1206Z	chip tray
C062Z	tray	C1210Z	chip tray
C512Z	1 pc. per bag	C1808Z	chip tray
		C1812Z	chip tray
		C1825Z	chip tray
		C2225Z	chip tray

DATA PACKAGE

A data package is sent with each shipment which contains:

- Summary of Group A testing
- Summary of Group B testing
- Group B Variables Test Data
- Lead Pull Data (Leaded Devices Only)
- Final Destructive Physical Analysis Report
- Certificate of Compliance stating that the ceramic capacitors supplied meet all the requirements of MIL-PRF-123, the applicable slash sheet(s) and all associated documents.

CAPACITOR OUTLINE DRAWINGS - (RADIAL LEADS)

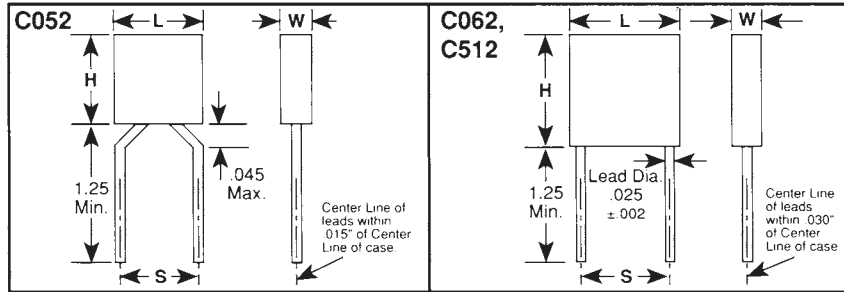

DIMENSIONS — INCHES & (MILLIMETERS)

CASE SIZE	MILITARY EQUIVALENT STYLES	H HEIGHT	L LENGTH	W WIDTH	S LEAD SPACING
C052	CKS05	.190 ± .010 (4.83 ± .25)	.190 ± .010 (4.83 ± .25)	.090 ± .010 (2.29 ± .25)	.200 ± .015 (5.08 ± .38)
C062	CKS06	.290 ± .010 (7.37 ± .25)	.290 ± .010 (7.37 ± .25)	.090 ± .010 (2.29 ± .25)	.200 ± .015 (5.08 ± .38)
C512	CKS07	.480 ± .020 (12.19 ± .51)	.480 ± .020 (12.19 ± .51)	.140 ± .010 (3.56 ± .25)*	.400 ± .020 (10.16 ± .51)

*0.200 maximum for some capacitance values.

ORDERING INFORMATION KEMET PART NUMBER

C 052 Z 102 K 5 G 5 C A

- CERAMIC CASE SIZE**: C (Radial), 052 (C052), 062 (C062), 512 (C512)
- SPECIFICATION**: Z — Mil-C-123
- CAPACITANCE**: In picofarad code (102)
- CAPACITANCE TOLERANCE**: Standard (K — ±10%)
- WORKING VOLTAGE**: 5 — 50, 1 — 100
- INTERNAL CONSTRUCTION**: 5 — Standard
- LEAD MATERIAL**: C — Standard, Radial: solder coated copper
- FAILURE RATE**: A — Standard — Not applicable

TEMPERATURE CHARACTERISTIC				
KEMET Designator	Military Equivalent	Temp. Range, °C	Capacitance Change With Temp.	
			Measured Without DC Bias Voltage	Measured With Bias (Rated) Voltage
G (Ultra Stable)	BP	-55 to +125	±30 ppm/°C	±30 ppm/°C
X (Stable)	BX	-55 to +125	±15%	+15% -25%

MIL-PRF-123 MILITARY PART NUMBER

M123 A 01 BX B 103 K C

MILITARY SPECIFICATION NUMBER

MODIFICATION LETTER
Indicates the latest characteristics of the part in the specification sheet.

MIL-PRF-123 SLASH SHEET NUMBER

Slash Sheet #	KEMET Style	Mil-C-123 Style
01	C052	CKS05
02	C062	CKS06
03	C512	CKS07

TERMINATION
Molded
C — Solder-coated copper (radial)

TOLERANCE
C—±0.25pF J—±5%
D—±0.5pF K—±10%
F—±1%

CAPACITANCE
In picofarad code

VOLTAGE

VOLTAGE-TEMPERATURE CHARACTERISTICS				
KEMET Designator	Military Equivalent	Capacitance Change With Temp.		
		Temp. Range, °C	Measured Without DC Bias Voltage	Measured (Rated) With Bias Voltage
G (Ultra Stable)	BP	-55 to +125	±30 ppm/°C	±30 ppm/°C
X (Stable)	BX	-55 to +125	±15%	+15% -25%

RATINGS & PART NUMBER REFERENCE

CAP. pF	KEMET PART NUMBER	MIL-PRF-123 PART NUMBER
100 VOLT - BP - C052 SIZE (MILITARY CKS05)		
4.7	C052Z4791G5CA	M123A01BPC4R71C
5.1	C052Z5191G5CA	M123A01BPC5R11C
5.6	C052Z5691G5CA	M123A01BPC5R61C
6.2	C052Z6291G5CA	M123A01BPC6R21C
6.8	C052Z6891G5CA	M123A01BPC6R81C
7.5	C052Z7591G5CA	M123A01BPC7R51C
8.2	C052Z8291G5CA	M123A01BPC8R21C
9.1	C052Z9191G5CA	M123A01BPC9R11C
10	C052Z10021G5CA	M123A01BPC1002C
11	C052Z11021G5CA	M123A01BPC1102C
12	C052Z12021G5CA	M123A01BPC1202C
13	C052Z13021G5CA	M123A01BPC1302C
15	C052Z15021G5CA	M123A01BPC1502C
16	C052Z16021G5CA	M123A01BPC1602C
18	C052Z18021G5CA	M123A01BPC1802C
20	C052Z20021G5CA	M123A01BPC2002C
22	C052Z22021G5CA	M123A01BPC2202C
24	C052Z24021G5CA	M123A01BPC2402C
27	C052Z27031G5CA	M123A01BPC2703C
30	C052Z30031G5CA	M123A01BPC3003C
33	C052Z33031G5CA	M123A01BPC3303C
36	C052Z36031G5CA	M123A01BPC3603C
39	C052Z39031G5CA	M123A01BPC3903C
43	C052Z43031G5CA	M123A01BPC4303C
47	C052Z47031G5CA	M123A01BPC4703C
51	C052Z51031G5CA	M123A01BPC5103C
56	C052Z56031G5CA	M123A01BPC5603C
62	C052Z62031G5CA	M123A01BPC6203C
68	C052Z68031G5CA	M123A01BPC6803C
75	C052Z75031G5CA	M123A01BPC7503C
82	C052Z82031G5CA	M123A01BPC8203C
91	C052Z91031G5CA	M123A01BPC9103C
100	C052Z10131G5CA	M123A01BPC1013C
110	C052Z11131G5CA	M123A01BPC1113C
120	C052Z12131G5CA	M123A01BPC1213C
130	C052Z13131G5CA	M123A01BPC1313C
150	C052Z15131G5CA	M123A01BPC1513C
160	C052Z16131G5CA	M123A01BPC1613C
180	C052Z18131G5CA	M123A01BPC1813C
200	C052Z20131G5CA	M123A01BPC2013C
220	C052Z22131G5CA	M123A01BPC2213C
240	C052Z24131G5CA	M123A01BPC2413C
50 VOLT - BP - C052 SIZE (MILITARY CKS05)		
270	C052Z2713G5CA	M123A01BPC2713C
300	C052Z3013G5CA	M123A01BPC3013C
330	C052Z3313G5CA	M123A01BPC3313C
360	C052Z3613G5CA	M123A01BPC3613C
390	C052Z3913G5CA	M123A01BPC3913C
430	C052Z4313G5CA	M123A01BPC4313C
470	C052Z4713G5CA	M123A01BPC4713C
510	C052Z5113G5CA	M123A01BPC5113C

CAP. pF	KEMET PART NUMBER	MIL-PRF-123 PART NUMBER
50 VOLT - BP - C052 SIZE (MILITARY CKS05) (Cont'd)		
560	C052Z5613G5CA	M123A01BPC5613C
620	C052Z6213G5CA	M123A01BPC6213C
680	C052Z6813G5CA	M123A01BPC6813C
750	C052Z7513G5CA	M123A01BPC7513C
820	C052Z8213G5CA	M123A01BPC8213C
910	C052Z9113G5CA	M123A01BPC9113C
1,000	C052Z1023G5CA	M123A01BPC1023C
1,100	C052Z1123G5CA	M123A01BPC1123C
1,200	C052Z1223G5CA	M123A01BPC1223C
1,300	C052Z1323G5CA	M123A01BPC1323C
1,500	C052Z1523G5CA	M123A01BPC1523C
1,600	C052Z1623G5CA	M123A01BPC1623C
1,800	C052Z1823G5CA	M123A01BPC1823C
2,000	C052Z2023G5CA	M123A01BPC2023C
2,200	C052Z2223G5CA	M123A01BPC2223C
2,400	C052Z2423G5CA	M123A01BPC2423C
2,700	C052Z2723G5CA	M123A01BPC2723C
100 VOLT - BP - C062 SIZE (MILITARY CKS06)		
270	C062Z2713G5CA	M123A02BPC2713C
300	C062Z3013G5CA	M123A02BPC3013C
330	C062Z3313G5CA	M123A02BPC3313C
360	C062Z3613G5CA	M123A02BPC3613C
390	C062Z3913G5CA	M123A02BPC3913C
430	C062Z4313G5CA	M123A02BPC4313C
470	C062Z4713G5CA	M123A02BPC4713C
510	C062Z5113G5CA	M123A02BPC5113C
560	C062Z5613G5CA	M123A02BPC5613C
620	C062Z6213G5CA	M123A02BPC6213C
680	C062Z6813G5CA	M123A02BPC6813C
750	C062Z7513G5CA	M123A02BPC7513C
820	C062Z8213G5CA	M123A02BPC8213C
910	C062Z9113G5CA	M123A02BPC9113C
1,000	C062Z1023G5CA	M123A02BPC1023C
1,100	C062Z1123G5CA	M123A02BPC1123C
1,200	C062Z1223G5CA	M123A02BPC1223C
1,300	C062Z1323G5CA	M123A02BPC1323C
1,500	C062Z1523G5CA	M123A02BPC1523C
1,600	C062Z1623G5CA	M123A02BPC1623C
1,800	C062Z1823G5CA	M123A02BPC1823C
2,000	C062Z2023G5CA	M123A02BPC2023C
2,200	C062Z2223G5CA	M123A02BPC2223C
2,400	C062Z2423G5CA	M123A02BPC2423C
50 VOLT - BP - C062 SIZE (MILITARY CKS06)		
2,700	C062Z2723G5CA	M123A02BPC2723C
3,000	C062Z3023G5CA	M123A02BPC3023C
3,300	C062Z3323G5CA	M123A02BPC3323C
3,600	C062Z3623G5CA	M123A02BPC3623C
3,900	C062Z3923G5CA	M123A02BPC3923C
4,300	C062Z4323G5CA	M123A02BPC4323C
4,700	C062Z4723G5CA	M123A02BPC4723C

RATINGS & PART NUMBER REFERENCE

CAP. pF	KEMET PART NUMBER	MIL-PRF-123 PART NUMBER
100 VOLT - BP - C512 SIZE (MILITARY CKS07)		
2,700	C512Z272G1G5CA	M123A03BPC272C
3,000	C512Z302G1G5CA	M123A03BPC302C
3,300	C512Z332G1G5CA	M123A03BPC332C
3,600	C512Z362G1G5CA	M123A03BPC362C
3,900	C512Z392G1G5CA	M123A03BPC392C
4,300	C512Z432G1G5CA	M123A03BPC432C
4,700	C512Z472G1G5CA	M123A03BPC472C
5,100	C512Z512G1G5CA	M123A03BPC512C
5,600	C512Z562G1G5CA	M123A03BPC562C
6,200	C512Z622G1G5CA	M123A03BPC622C
6,800	C512Z682G1G5CA	M123A03BPC682C
7,500	C512Z752G1G5CA	M123A03BPC752C
8,200	C512Z822G1G5CA	M123A03BPC822C
9,100	C512Z912G1G5CA	M123A03BPC912C
10,000	C512Z103G1G5CA	M123A03BPC103C
50 VOLT - BP - C512 SIZE (MILITARY CKS07)		
11,000	C512Z113G5G5CA	M123A03BPB113C
12,000	C512Z123G5G5CA	M123A03BPB123C
13,000	C512Z133G5G5CA	M123A03BPB133C
15,000	C512Z153G5G5CA	M123A03BPB153C
16,000	C512Z163G5G5CA	M123A03BPB163C
18,000	C512Z183G5G5CA	M123A03BPB183C
20,000	C512Z203G5G5CA	M123A03BPB203C
22,000	C512Z223G5G5CA	M123A03BPB223C
24,000	C512Z243G5G5CA	M123A03BPB243C
27,000	C512Z273G5G5CA	M123A03BPB273C
30,000	C512Z303G5G5CA	M123A03BPB303C
33,000	C512Z333G5G5CA	M123A03BPB333C
36,000	C512Z363G5G5CA	M123A03BPB363C
39,000	C512Z393G5G5CA	M123A03BPB393C
43,000	C512Z433G5G5CA	M123A03BPB433C
47,000	C512Z473G5G5CA	M123A03BPB473C
51,000	C512Z513G5G5CA	M123A03BPB513C
56,000	C512Z563G5G5CA	M123A03BPB563C
62,000	C512Z623G5G5CA	M123A03BPB623C
68,000	C512Z683G5G5CA	M123A03BPB683C
75,000	C512Z753G5G5CA	M123A03BPB753C
82,000	C512Z823G5G5CA	M123A03BPB823C
91,000	C512Z913G5G5CA	M123A03BPB913C
100,000	C512Z104G5G5CA	M123A03BPB104C

CAP. pF	KEMET PART NUMBER	MIL-PRF-123 PART NUMBER
100 VOLT - BX - C062 SIZE (MILITARY CKS06)		
5,600	C062Z562K1X5CA	M123A02BXC562KC
6,800	C062Z682K1X5CA	M123A02BXC682KC
8,200	C062Z822K1X5CA	M123A02BXC822KC
10,000	C062Z103K1X5CA	M123A02BXC103KC
12,000	C062Z123K1X5CA	M123A02BXC123KC
15,000	C062Z153K1X5CA	M123A02BXC153KC
18,000	C062Z183K1X5CA	M123A02BXC183KC
22,000	C062Z223K1X5CA	M123A02BXC223KC
27,000	C062Z273K1X5CA	M123A02BXC273KC
33,000	C062Z333K1X5CA	M123A02BXC333KC
39,000	C062Z393K1X5CA	M123A02BXC393KC
47,000	C062Z473K1X5CA	M123A02BXC473KC
56,000	C062Z563K1X5CA	M123A02BXC563KC
68,000	C062Z683K1X5CA	M123A02BXC683KC
82,000	C062Z823K1X5CA	M123A02BXC823KC
100,000	C062Z104K1X5CA	M123A02BXC104KC
50 VOLT - BX - C062 SIZE (MILITARY CKS06)		
56,000	C062Z563K5X5CA	M123A02BXB563KC
68,000	C062Z683K5X5CA	M123A02BXB683KC
82,000	C062Z823K5X5CA	M123A02BXB823KC
100,000	C062Z104K5X5CA	M123A02BXB104KC
120,000	C062Z124K5X5CA	M123A02BXB124KC
150,000	C062Z154K5X5CA	M123A02BXB154KC
180,000	C062Z184K5X5CA	M123A02BXB184KC
220,000	C062Z224K5X5CA	M123A02BXB224KC
270,000	C062Z274K5X5CA	M123A02BXB274KC
330,000	C062Z334K5X5CA	M123A02BXB334KC
390,000	C062Z394K5X5CA	M123A02BXB394KC
470,000	C062Z474K5X5CA	M123A02BXB474KC
560,000	C062Z564K5X5CA	M123A02BXB564KC
680,000	C062Z684K5X5CA	M123A02BXB684KC
820,000	C062Z824K5X5CA	M123A02BXB824KC
1,000,000	C062Z105K5X5CA	M123A02BXB105KC

CAP. pF	KEMET PART NUMBER	MIL-PRF-123 PART NUMBER
100 VOLT - BX - C052 SIZE (MILITARY CKS05)		
270	C052Z271K1X5CA	M123A01BXC271KC
330	C052Z331K1X5CA	M123A01BXC331KC
390	C052Z391K1X5CA	M123A01BXC391KC
470	C052Z471K1X5CA	M123A01BXC471KC
560	C052Z561K1X5CA	M123A01BXC561KC
680	C052Z681K1X5CA	M123A01BXC681KC
820	C052Z821K1X5CA	M123A01BXC821KC
1,000	C052Z102K1X5CA	M123A01BXC102KC
1,200	C052Z122K1X5CA	M123A01BXC122KC
1,500	C052Z152K1X5CA	M123A01BXC152KC
1,800	C052Z182K1X5CA	M123A01BXC182KC
2,200	C052Z222K1X5CA	M123A01BXC222KC
2,700	C052Z272K1X5CA	M123A01BXC272KC
3,300	C052Z332K1X5CA	M123A01BXC332KC
3,900	C052Z392K1X5CA	M123A01BXC392KC
4,700	C052Z472K1X5CA	M123A01BXC472KC
50 VOLT - BX - C052 SIZE (MILITARY CKS05)		
5,600	C052Z562K5X5CA	M123A01BXB562KC
6,800	C052Z682K5X5CA	M123A01BXB682KC
8,200	C052Z822K5X5CA	M123A01BXB822KC
10,000	C052Z103K5X5CA	M123A01BXB103KC

CAP. pF	KEMET PART NUMBER	MIL-PRF-123 PART NUMBER
100 VOLT - BX - C512 SIZE (MILITARY CKS07)		
56,000	C512Z563K1X5CA	M123A03BXC563KC
68,000	C512Z683K1X5CA	M123A03BXC683KC
82,000	C512Z823K1X5CA	M123A03BXC823KC
100,000	C512Z104K1X5CA	M123A03BXC104KC
120,000	C512Z124K1X5CA	M123A03BXC124KC
150,000	C512Z154K1X5CA	M123A03BXC154KC
180,000	C512Z184K1X5CA	M123A03BXC184KC
220,000	C512Z224K1X5CA	M123A03BXC224KC
270,000	C512Z274K1X5CA	M123A03BXC274KC
330,000	C512Z334K1X5CA	M123A03BXC334KC
390,000	C512Z394K1X5CA	M123A03BXC394KC
470,000	C512Z474K1X5CA	M123A03BXC474KC
50 VOLT - BX - C512 SIZE (MILITARY CKS07)		
560,000	C512Z564K5X5CA	M123A03BXB564KC
680,000	C512Z684K5X5CA	M123A03BXB684KC
820,000	C512Z824K5X5CA	M123A03BXB824KC
1,000,000	C512Z105K5X5CA	M123A03BXB105KC

To complete the part numbers, insert the following tolerances: (1) C, ±0.25pF; D, ±0.5pF (2) C, ±0.25pF; J, ±5%; K, ±10% (3) F, ±1%; J, ±5%; K, ±10%

MARKING INFORMATION

C052Z
M123A 01BPC 4R7CC
MIL-PRF-123 Part Number

C062Z, C512Z
M123A 02BPC 271FC JAN
MIL-PRF-123 Part Number "JAN"

CAGE = Commercial and Government Entity

JAN — "JAN"
XXXX* — Date Lot Code
31433 — CAGE

271F — Capacitance Code & Tolerance
100V — Voltage
XXXX* — Date Lot Code
31433 — CAGE

CAPACITOR OUTLINE DRAWINGS

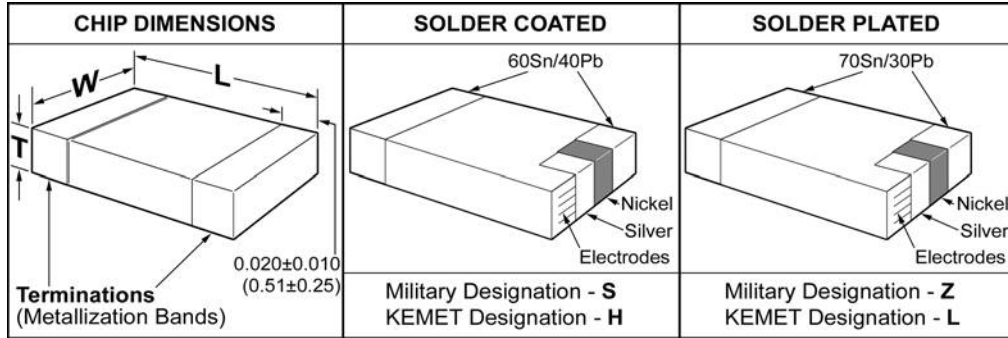

NOTE: For solder coated termination, add 0.015" (0.38mm) to the positive width and thickness tolerances. Add the following to the positive length tolerance: **CKS51** - 0.020" (0.51mm); **CKS52, CKS53 and CKS54** - 0.025 (0.64mm); add 0.012" (0.30mm) to the bandwidth tolerance.

DIMENSIONS — INCHES

Chip Size	Military Equivalent Styles	L Length	W Width	T Thickness Maximum
0805	CKS51	0.080 ± 0.015	0.050 ± 0.015	0.055
1210	CKS52	0.120 ± 0.015	0.100 ± 0.015	0.065
1808	CKS53	0.180 ± 0.015	0.080 ± 0.015	0.065
2225	CKS54	0.220 ± 0.015	0.250 ± 0.015	0.070
1206	CKS55	0.120 ± 0.015	0.060 ± 0.015	0.065
1812	CKS56	0.180 ± 0.015	0.125 ± 0.015	0.080
1825	CKS57	0.180 ± 0.015	0.250 ± 0.015	0.080

MARKING

Capacitors shall be legibly laser marked in contrasting color with the KEMET trademark and 2-digit capacitance symbol.

KEMET ORDERING INFORMATION

Ceramic Chip Size

0805, 1206, 1210, 1808, 1812, 1825, 2225

Specification

Z — Mil-PRF-123

Capacitance Picofarad Code

First two digits represent significant figures. Third digit specifies number of zeros to follow.

Capacitance Tolerance

C — ±0.25pF J — ±5%
 D — ±0.5 pF K — ±10%
 F — ±1%

Working Voltage

5 — 50; 1 — 100

Termination
 H = Nickel Guarded, Solder-Coated (Sn60)
 L = 70/30 Tin/Lead Plated

Failure Rate
 (%/1000 Hours)
 A - Standard — Not Applicable

Temperature Characteristic

KEMET Designator	Military Equivalent	Temp. Range, °C	Measured Without DC Bias Voltage	Measured With Bias (Rated Voltage)
G (Ultra Stable)	BP	-55 to +125	±30 ppm °C	±30 ppm °C
X (Stable)	BX	-55 to +125	±15%	+15% -25%

M123 A 10 BX B 472 K Z

Military Specification Number

Modification Number

Indicates the latest characteristics of the part in the specification sheet

MIL-PRF-123 Slash Sheet Number

Slash Sheet #	KEMET Style	MIL-PRF-123 Style
10	C0805	CKS51
11	C1210	CKS52
12	C1808	CKS53
13	C2225	CKS54
21	C1206	CKS55
22	C1812	CKS56
23	C1825	CKS57

Termination
 Z = 70/30 Tin Lead Plated
 S = Nickel guarded Solder-coated (Sn60)

Tolerance
 C = ±0.25pF; D = ±0.5pF;
 F = ±1%; J = ±5%; K = ± 10%

Capacitance Picofarad Code

Voltage
 B = 50; C = 100

Temperature Characteristic

KEMET Designator	Military Equivalent	Temp. Range, °C	Capacitance Change with Temperature	
			Measured Without DC Bias Voltage	Measured With Bias (Rated Voltage)
G (UltraStable)	BP	-55 to 125	±30 ppm°C	±30 ppm°C
X (Stable)	BX	-55 to +125	±15%	+15% -25%

RATINGS AND PART NUMBER REFERENCE

CAP. pF	KEMET PART NUMBER	MIL-PRF-123 PART NUMBER
100 VOLT - BP - C1206 SIZE (MILITARY CKS55)		
1.0	C1206Z109(4)1GA(9)	M123A21BPC1R0(4)(10)
1.1	C1206Z119(4)1GA(9)	M123A21BPC1R1(4)(10)
1.2	C1206Z129(4)1GA(9)	M123A21BPC1R2(4)(10)
1.3	C1206Z139(4)1GA(9)	M123A21BPC1R3(4)(10)
1.5	C1206Z159(4)1GA(9)	M123A21BPC1R5(4)(10)
1.6	C1206Z169(4)1GA(9)	M123A21BPC1R6(4)(10)
1.8	C1206Z189(4)1GA(9)	M123A21BPC1R8(4)(10)
2.0	C1206Z209(4)1GA(9)	M123A21BPC2R0(4)(10)
2.2	C1206Z229(4)1GA(9)	M123A21BPC2R2(4)(10)
2.4	C1206Z249(4)1GA(9)	M123A21BPC2R4(4)(10)
2.7	C1206Z279(5)1GA(9)	M123A21BPC2R7(5)(10)
3.0	C1206Z309(5)1GA(9)	M123A21BPC3R0(5)(10)
3.3	C1206Z339(5)1GA(9)	M123A21BPC3R3(5)(10)
3.6	C1206Z369(5)1GA(9)	M123A21BPC3R6(5)(10)
3.9	C1206Z399(5)1GA(9)	M123A21BPC3R9(5)(10)
4.3	C1206Z439(5)1GA(9)+	M123A21BPC4R3(5)(10)
4.7	C1206Z479(5)1GA(9)	M123A21BPC4R7(5)(10)
5.1	C1206Z519(5)1GA(9)	M123A21BPC5R1(5)(10)
5.6	C1206Z569(5)1GA(9)	M123A21BPC5R6(5)(10)
6.2	C1206Z629(5)1GA(9)	M123A21BPC6R2(5)(10)
6.8	C1206Z689(5)1GA(9)	M123A21BPC6R8(5)(10)
7.5	C1206Z759(5)1GA(9)	M123A21BPC7R5(5)(10)
8.2	C1206Z829(5)1GA(9)	M123A21BPC8R2(5)(10)
9.1	C1206Z919(5)1GA(9)	M123A21BPC9R1(5)(10)
10.0	C1206Z100(3)1GA(9)	M123A21BPC100(3)(10)
11.0	C1206Z110(3)1GA(9)	M123A21BPC110(3)(10)
12.0	C1206Z120(3)1GA(9)	M123A21BPC120(3)(10)
13.0	C1206Z130(3)1GA(9)	M123A21BPC130(3)(10)
15.0	C1206Z150(3)1GA(9)	M123A21BPC150(3)(10)
16.0	C1206Z160(3)1GA(9)	M123A21BPC160(3)(10)
18.0	C1206Z180(3)1GA(9)	M123A21BPC180(3)(10)
20.0	C1206Z200(3)1GA(9)	M123A21BPC200(3)(10)
24.0	C1206Z240(3)1GA(9)	M123A21BPC240(3)(10)
27.0	C1206Z270(3)1GA(9)	M123A21BPC270(3)(10)
33.0	C1206Z330(3)1GA(9)	M123A21BPC330(3)(10)
36.0	C1206Z360(3)1GA(9)	M123A21BPC360(3)(10)
39.0	C1206Z390(3)1GA(9)	M123A21BPC390(3)(10)
43.0	C1206Z430(3)1GA(9)	M123A21BPC430(3)(10)
47.0	C1206Z470(3)1GA(9)	M123A21BPC470(3)(10)
51.0	C1206Z510(3)1GA(9)	M123A21BPC510(3)(10)
56.0	C1206Z560(3)1GA(9)	M123A21BPC560(3)(10)
62.0	C1206Z620(3)1GA(9)	M123A21BPC620(3)(10)
68.0	C1206Z680(3)1GA(9)	M123A21BPC680(3)(10)
75.0	C1206Z750(3)1GA(9)	M123A21BPC750(3)(10)
82.0	C1206Z820(3)1GA(9)	M123A21BPC820(3)(10)
91.0	C1206Z910(3)1GA(9)	M123A21BPC910(3)(10)
100.0	C1206Z101(3)1GA(9)	M123A21BPC101(3)(10)
110.0	C1206Z111(3)1GA(9)	M123A21BPC111(3)(10)
120.0	C1206Z121(3)1GA(9)	M123A21BPC121(3)(10)
130.0	C1206Z131(3)1GA(9)	M123A21BPC131(3)(10)
150.0	C1206Z151(3)1GA(9)	M123A21BPC151(3)(10)
160.0	C1206Z161(3)1GA(9)	M123A21BPC161(3)(10)
180.0	C1206Z181(3)1GA(9)	M123A21BPC181(3)(10)
200.0	C1206Z201(3)1GA(9)	M123A21BPC201(3)(10)
220.0	C1206Z221(3)1GA(9)	M123A21BPC221(3)(10)
240.0	C1206Z241(3)1GA(9)	M123A21BPC241(3)(10)
270.0	C1206Z271(3)1GA(9)	M123A21BPC271(3)(10)
300.0	C1206Z301(3)1GA(9)	M123A21BPC301(3)(10)
330.0	C1206Z331(3)1GA(9)	M123A21BPC331(3)(10)
360.0	C1206Z361(3)1GA(9)	M123A21BPC361(3)(10)
390.0	C1206Z391(3)1GA(9)	M123A21BPC391(3)(10)
430.0	C1206Z431(3)1GA(9)	M123A21BPC431(3)(10)
470.0	C1206Z471(3)1GA(9)	M123A21BPC471(3)(10)
510.0	C1206Z511(3)1GA(9)	M123A21BPC511(3)(10)
560.0	C1206Z561(3)1GA(9)	M123A21BPC561(3)(10)
620.0	C1206Z621(3)1GA(9)	M123A21BPC621(3)(10)
680.0	C1206Z681(3)1GA(9)	M123A21BPC681(3)(10)
750.0	C1206Z751(3)1GA(9)	M123A21BPC751(3)(10)
820.0	C1206Z821(3)1GA(9)	M123A21BPC821(3)(10)
910.0	C1206Z911(3)1GA(9)	M123A21BPC911(3)(10)
1000.0	C1206Z102(3)1GA(9)	M123A21BPC102(3)(10)

CAP. pF	KEMET PART NUMBER	MIL-PRF-123 PART NUMBER
50 VOLT-BP-C1206 SIZE (MILITARY CKS55)		
1,100.0	C1206Z112(3)5GA(9)	M123A21BPB112(3)(10)
1,200.0	C1206Z122(3)5GA(9)	M123A21BPB122(3)(10)
1,300.0	C1206Z132(3)5GA(9)	M123A21BPB132(3)(10)
1,500.0	C1206Z152(3)5GA(9)	M123A21BPB152(3)(10)
1,600.0	C1206Z162(3)5GA(9)	M123A21BPB162(3)(10)
1,800.0	C1206Z182(3)5GA(9)	M123A21BPB182(3)(10)
2,000.0	C1206Z202(3)5GA(9)	M123A21BPB202(3)(10)
2,200.0	C1206Z222(3)5GA(9)	M123A21BPB222(3)(10)
100 VOLT-BX-C1206 SIZE (MILITARY CKS55)		
4,700.0	C1206Z472(6)1XA(9)	M123A21BXC472(6)(10)
5,600.0	C1206Z562(6)1XA(9)	M123A21BXC562(6)(10)
6,800.0	C1206Z682(6)1XA(9)	M123A21BXC682(6)(10)
8,200.0	C1206Z822(6)1XA(9)	M123A21BXC822(6)(10)
10,000.0	C1206Z103(6)1XA(9)	M123A21BXC103(6)(10)
12,000.0	C1206Z123(6)1XA(9)	M123A21BXC123(6)(10)
15,000.0	C1206Z153(6)1XA(9)	M123A21BXC153(6)(10)
50 VOLT-BX-C1206 SIZE (MILITARY CKS55)		
18,000.0	C1206Z183(6)5XA(9)	M123A21BXC183(6)(10)
22,000.0	C1206Z223(6)5XA(9)	M123A21BXC223(6)(10)
27,000.0	C1206Z273(6)5XA(9)	M123A21BXC273(6)(10)
33,000.0	C1206Z333(6)5XA(9)	M123A21BXC333(6)(10)
39,000.0	C1206Z393(6)5XA(9)	M123A21BXC393(6)(10)
100 VOLT-BP-C1812 SIZE (MILITARY CKS56)		
1,200.0	C1812Z122(3)1GA(9)	M123A22BPC122(3)(10)
2,200.0	C1812Z222(3)1GA(9)	M123A22BPC222(3)(10)
2,400.0	C1812Z242(3)1GA(9)	M123A22BPC242(3)(10)
2,700.0	C1812Z272(3)1GA(9)	M123A22BPC272(3)(10)
3,000.0	C1812Z302(3)1GA(9)	M123A22BPC302(3)(10)
3,300.0	C1812Z332(3)1GA(9)	M123A22BPC332(3)(10)
3,600.0	C1812Z362(3)1GA(9)	M123A22BPC362(3)(10)
3,900.0	C1812Z392(3)1GA(9)	M123A22BPC392(3)(10)
4,300.0	C1812Z432(3)1GA(9)	M123A22BPC432(3)(10)
4,700.0	C1812Z472(3)1GA(9)	M123A22BPC472(3)(10)
50 VOLT-BP-C1812 SIZE (MILITARY CKS56)		
5,100.0	C1812Z512(3)5GA(9)	M123A22BPB512(3)(10)
5,600.0	C1812Z562(3)5GA(9)	M123A22BPB562(3)(10)
6,200.0	C1812Z622(3)5GA(9)	M123A22BPB622(3)(10)
6,800.0	C1812Z682(3)5GA(9)	M123A22BPB682(3)(10)
7,500.0	C1812Z752(3)5GA(9)	M123A22BPB752(3)(10)
8,200.0	C1812Z822(3)5GA(9)	M123A22BPB822(3)(10)
9,100.0	C1812Z912(3)5GA(9)	M123A22BPB912(3)(10)
10,000.0	C1812Z103(3)5GA(9)	M123A22BPB103(3)(10)
100 VOLT-BX-C1812 SIZE (MILITARY CKS56)		
27,000.0	C1812Z273(6)1XA(9)	M123A22BXC273(6)(10)
33,000.0	C1812Z333(6)1XA(9)	M123A22BXC333(6)(10)
39,000.0	C1812Z393(6)1XA(9)	M123A22BXC393(6)(10)
47,000.0	C1812Z473(6)1XA(9)	M123A22BXC473(6)(10)
56,000.0	C1812Z563(6)1XA(9)	M123A22BXC563(6)(10)
50 VOLT-BX-C1812 SIZE (MILITARY CKS56)		
100,000.0	C1812Z104(6)5XA(9)	M123A22BXC104(6)(10)
120,000.0	C1812Z124(6)5XA(9)	M123A22BXC124(6)(10)
150,000.0	C1812Z154(6)5XA(9)	M123A22BXC154(6)(10)
180,000.0	C1812Z184(6)5XA(9)	M123A22BXC184(6)(10)

CAP. pF	KEMET PART NUMBER	MIL-PRF-123 PART NUMBER
100 VOLT-BP-C1825 SIZE (MILITARY CKS57)		
3,900.0	C1825Z392(3)1GA(9)	M123A23BPC392(3)(10)
4,700.0	C1825Z472(3)1GA(9)	M123A23BPC472(3)(10)
5,100.0	C1825Z512(3)1GA(9)	M123A23BPC512(3)(10)
5,600.0	C1825Z562(3)1GA(9)	M123A23BPC562(3)(10)
6,200.0	C1825Z622(3)1GA(9)	M123A23BPC622(3)(10)
6,800.0	C1825Z682(3)1GA(9)	M123A23BPC682(3)(10)
7,500.0	C1825Z752(3)1GA(9)	M123A23BPC752(3)(10)
8,200.0	C1825Z822(3)1GA(9)	M123A23BPC822(3)(10)
9,100.0	C1825Z912(3)1GA(9)	M123A23BPC912(3)(10)
10,000.0	C1825Z103(3)1GA(9)	M123A23BPC103(3)(10)
50 VOLT-BP-C1812 SIZE (MILITARY CKS57)		
11,000.0	C1825Z113(3)5GA(9)	M123A23BPB113(3)(10)
12,000.0	C1825Z123(3)5GA(9)	M123A23BPB123(3)(10)
13,000.0	C1825Z133(3)5GA(9)	M123A23BPB133(3)(10)
15,000.0	C1825Z153(3)5GA(9)	M123A23BPB153(3)(10)
16,000.0	C1825Z163(3)5GA(9)	M123A23BPB163(3)(10)
18,000.0	C1825Z183(3)5GA(9)	M123A23BPB183(3)(10)
20,000.0	C1825Z203(3)5GA(9)	M123A23BPB203(3)(10)
22,000.0	C1825Z223(3)5GA(9)	M123A23BPB223(3)(10)
100 VOLT-BX-C1825 SIZE (MILITARY CKS57)		
56,000.0	C1825Z563(6)1XA(9)	M123A23BXC563(6)(10)
68,000.0	C1825Z683(6)1XA(9)	M123A23BXC683(6)(10)
82,000.0	C1825Z823(6)1XA(9)	M123A23BXC823(6)(10)
100,000.0	C1825Z104(6)1XA(9)	M123A23BXC104(6)(10)
120,000.0	C1825Z124(6)1XA(9)	M123A23BXC124(6)(10)
150,000.0	C1825Z154(6)1XA(9)	M123A23BXC154(6)(10)
50 VOLT-BX-C1825 SIZE (MILITARY CKS57)		
180,000.0	C1825Z184(6)5XA(9)	M123A23BXC184(6)(10)
220,000.0	C1825Z224(6)5XA(9)	M123A23BXC224(6)(10)
270,000.0	C1825Z274(6)5XA(9)	M123A23BXC274(6)(10)
330,000.0	C1825Z334(6)5XA(9)	M123A23BXC334(6)(10)
390,000.0	C1825Z394(6)5XA(9)	M123A23BXC394(6)(10)
470,000.0	C1825Z474(6)5XA(9)	M123A23BXC474(6)(10)

To complete the KEMET part numbers, insert the following tolerance:

- (1) C = ±0.25pF; D = ±0.5pF
- (2) C = ±0.25pF; J = ±5%; K = ±10%
- (3) F = ±1%; J = ±5%; K = ±10%
- (4) B = ±0.1pF; C = ±0.25pF
- (5) B = ±0.1pF; C = 0.25pF; D = 0.50pF
- (6) K = ±10%; M = ±20%

To complete the KEMET part numbers, insert the following voltage:

- (7) B = 50 volts; C = 100 volts
- (8) 5 = 50 volts; 1 = 100 volts

To complete the KEMET part numbers, insert termination designation:

- (9) H = Nickel Guarded, Solder Coated (Sn60); L = 70/30 Tin/Lead Plated
- (10) S = Nickel Guarded, Solder Coated (Sn60); Z = 70/30 Tin/Lead Plated

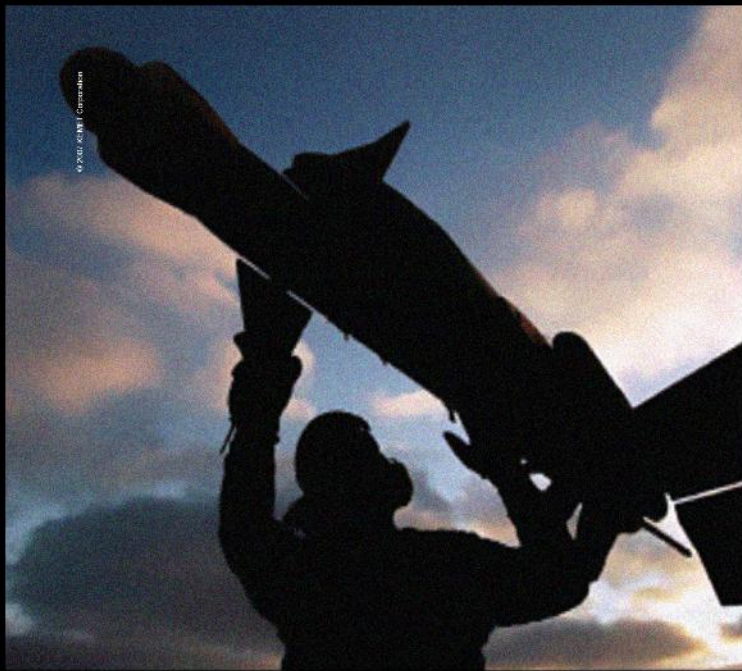

Ceramic High Reliability Capacitors

www.kemet.com

F-3054H 12/07

The Capacitance Company
KEMET
CHARGED.™

CERAMIC HIGH RELIABILITY PRODUCTS

Ceramic Chips, Radial Molded

KEMET Electronics Corporation has been known for many years as the leader in the ceramic high reliability products. KEMET produces high reliability monolithic ceramic capacitors under tightly-controlled manufacturing procedures. These capacitors achieve “State of the Art” performance by virtue of careful materials selection, conservative design rules, motivational training of employees, and scrupulous inspection of all processes as well as the finished product. KEMET not only manufactures its own high reliability ceramic capacitor (GR900), KEMET also manufactures MIL-PRF-123 product which is built to the highest military standard in the industry today.

BASIC REQUIREMENTS FOR KEMET'S HIGH RELIABILITY PRODUCTS ARE AS FOLLOWS:

- 1. Selected Raw Materials:** All raw materials are selected for characteristics known to produce the finest quality capacitors exhibiting the best electrical parameters and physical integrity. Materials traceability is maintained throughout the manufacturing process.
- 2. Batch Homogeneity:** Production is under batch control. Each batch is homogeneous with respect to materials, design and processing conditions.
- 3. Clean Room Processing:** All processes sensitive to particulate contamination take place in a clean room environment.
- 4. Special Designs:** Special design considerations such as dielectric thickness are strictly enforced. Only C0G (BP) and X7R (BX) temperature characteristics are made.
- 5. Destructive Physical Analysis (DPA, or Cross-Sectioning):** All batches are sampled using EIA-469 as a minimum requirement. The samples remain on file and DPA Reports are shipped with the capacitors.
- 6. C-SAM (C-Mode Surface Acoustical Microscopy):** Optional 100% screening may be performed using ultrasonic energy to detect voids or delaminations. Screened lots must pass a final sample DPA.
- 7. Batch Performance Monitoring:** All production batches are tested to generate electrical characteristics. Batches which show anomalous characteristics are rejected.
- 8. Special Customer Requirements:** Many special

requirements such as serialization, DPA samples, X-Ray plates, and special packaging can be accommodated.

9. Document Applicable: The high reliability product is implemented through various internal documents under revision control. The Manufacturing Instructions provide detailed descriptions of all operations and delineate requirements for process control and product performance at various points in the process flow. Inspector Operating Documents describe test procedures and sampling plans for inspection of raw materials, in-process material and finished product. Raw material specifications describe physical and chemical characteristics as well as the packaging and labeling needed to preserve characteristics and identity. Customer specifications are internal documents applicable only to products manufactured and inspected to requirements of individual customers; in effect, these documents translate customer drawings into modifications of the specified portions of KEMET standard procedures.

The Quality System in total is controlled by the KEMET Quality Manual and by various Quality Operating Documents. All documents, and revisions thereto, bear specified approval signatures.

DETAILED SPECIFICATION: Temperature Characteristics

Electrical stability with respect to temperature and voltage is related inversely to the packaging efficiency (capacitance X voltage in a given case size). C0G (BP) is made from ceramic materials which are not ferroelectric, yielding superior stability but low packaging efficiency. X7R (BX) is made from materials which are ferroelectric, such as barium titanate, yielding a stable and high packaging efficiency.

Aging

If the temperature of a barium titanate dielectric is lowered after an excursion above its curie point, the ceramic crystalline structure gradually reverts to the tetragonal form typical of the low temperature conditions. The reversion requires a considerable length of time, and its effect in practical capacitors has become known as “Aging”. The rate of aging is affected by both the temperature and the applied voltage experienced by the capacitor. The COG (BP) formulation is non-ferroelectric and does not exhibit

aging. The X7R (BX) formulation exhibits its own characteristic aging rate which describes a decrease in capacitance versus time. The capacitance of the X7R dielectric decreases approximately 1.0% during each decade of hours following a return to temperatures below the curie point. In other words, capacitance will decrease 1.0% between 1 and 10 hours, another 1.0% between 10 and 100 hours, another 1.0% between 100 and 1000 hours, etc.

KEMET takes into consideration the aging rate by designing capacitors to fall within the specified capacitance tolerance at 1000 hours. Inasmuch as the aging rate is exponential, very little change in capacitance will take place after 1000 hours.

Voltage Effects

Ferroelectric materials are also affected by applied voltage, both alternating and direct. Low values of voltage produce a slight increase in capacitance and dissipation factor. Higher voltages cause a decrease in capacitance. Typically, capacitors with X7R characteristic decrease in capacitance by approximately 10% when rated DC voltage is applied.

A small portion of the decrease in capacitance by the application of a high DC voltage persists after the voltage is removed and then disappears gradually.

Customer Testing

Because of temperature and voltage effects, caution must be used in establishing a testing sequence for ceramic capacitors. Insulation resistance measurements and tests of dielectric withstanding voltage both require application of high DC voltage and cause temporary changes in capacitance. These tests, therefore, should not be conducted until capacitance testing is completed. Alternatively, the capacitors can be "de-aged" at high temperature as described above. A stabilization time at room ambient of 24 hours should be used after de-aging.

See F-3101 Catalog for more details.

PERFORMANCE CHARACTERISTICS

General Information

Working Voltage:

C0G (BP) - 50,100 & 200 volts

X7R (BX) - 50,100 & 200 volts

Temperature Characteristics:

C0G (BP): 0 \pm 30 ppm/ $^{\circ}$ C from -55 $^{\circ}$ C to +125 $^{\circ}$ C.
(Limits widen below 20 pF.)

X7R (BX): \pm 15%; from -55 $^{\circ}$ C to +125 $^{\circ}$ C.

Capacitance Tolerance:

C0G (BP): C - \pm 0.25pF; D - \pm 0.5pF; F - \pm 1%;

G - \pm 2%; J - \pm 5%; K - \pm 10%; M - \pm 20%.

X7R (BX): J - \pm 5%; K - \pm 10%; M - \pm 20%.

Electrical

Capacitance: Within specified tolerance when measured with 1 volt RMS @ 1 kHz (1000pF or less @ 1 MHz for C0G (BP)).

Dissipation Factor:

25 $^{\circ}$ C @ 1 kHz (1000 pF or less at 1 MHz for C0G (BP)).

C0G (BP): 0.15% maximum

X7R (BX): 2.5% maximum

Insulation Resistance:

After 2 minutes electrification:

at 25 $^{\circ}$ C and rated voltage:

C0G (BP): 100 G Ω or (1000 megohm X μ F), whichever is less.

X7R (BX): 100 G Ω or (1000 megohm X μ F), whichever is less.

at 125 $^{\circ}$ C and rated voltage:

C0G (BP): 10 G Ω or (100 megohm X μ F), whichever is less.

X7R (BX): 10 G Ω or (100 megohm X μ F), whichever is less.

Dielectric Withstanding Voltage: 250% of rated voltage for 5 seconds with current limited to 50 MA at 25 $^{\circ}$ C.

Aging Rate: % Delta Cap/Decade Hour, Typical

C0G (BP): 0%

X7R (BX): 1.0%

IMPORTANT NOTICE

KEMET Electronics Corporation disclaims all warranties, whether express, implied, or statutory as to any manner whatsoever, including the condition of the equipment, its compatibility with specific requirements, its merchantability, or fitness for any particular purpose which extend beyond the description on the face hereof.

Furthermore, under no circumstances shall KEMET Electronics Corporation be liable for consequential, special, incidental or indirect damages resulting from the use or handling of this product.

Finally, KEMET Electronics Corporation does not assume any responsibility for the correctness of the information contained in this catalog. All design characteristics, specifications, tolerances, and the like are subject to change without notice.

MIL-PRF-123/GR900
TYPICAL PERFORMANCE CURVES

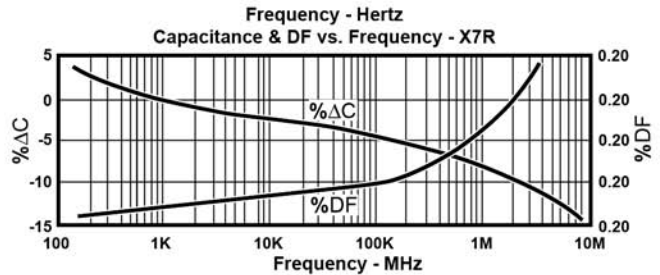
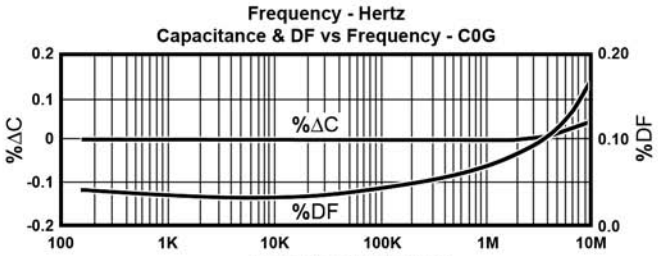
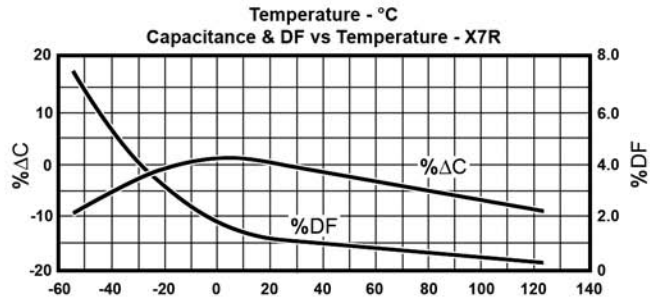
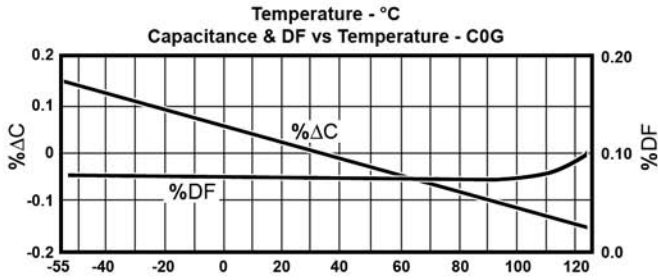

AC or DC Volts Applied
Typical Effect of 100Hz AC and DC Voltage Level on Capacitance and Dissipation Factor - X7R
Note: C0G Dielectric capacitance and dissipation factor are stable with voltage

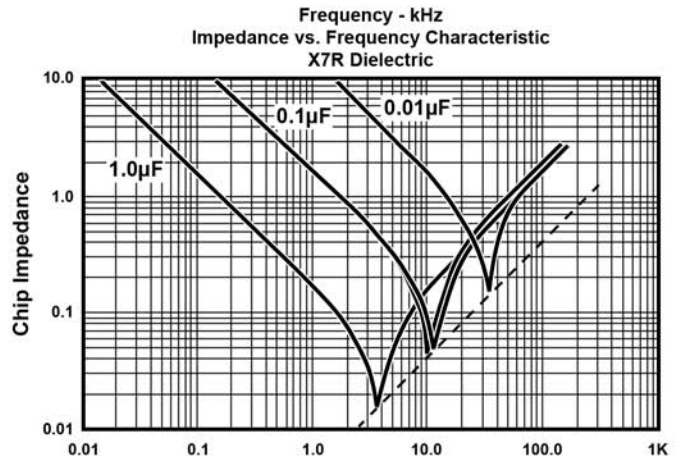
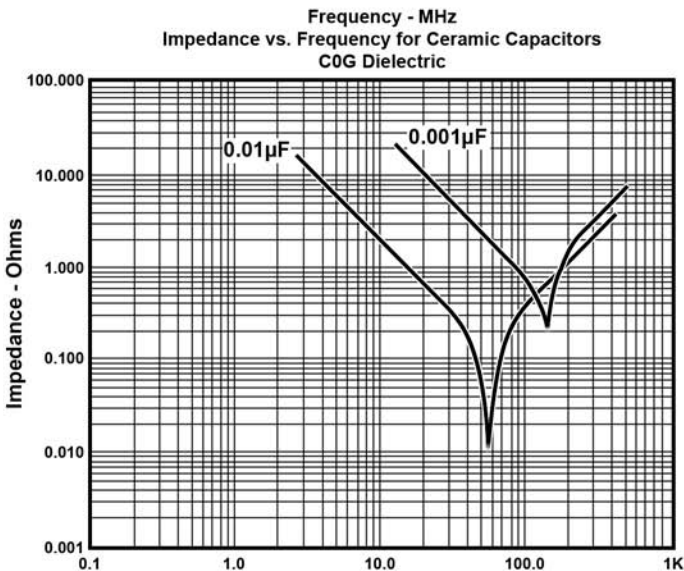
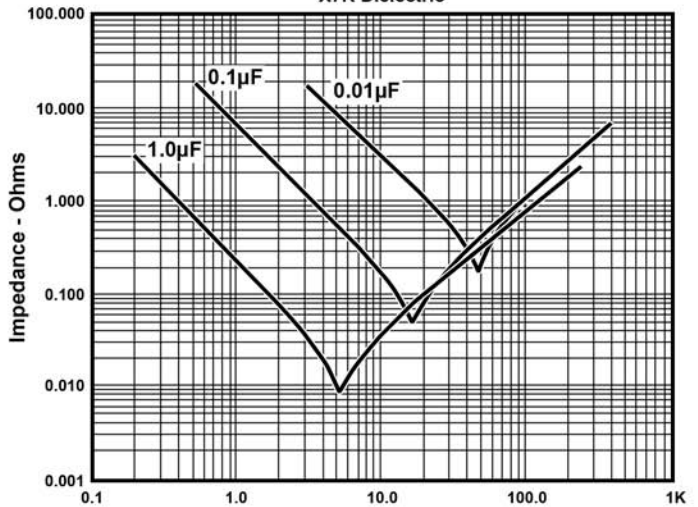
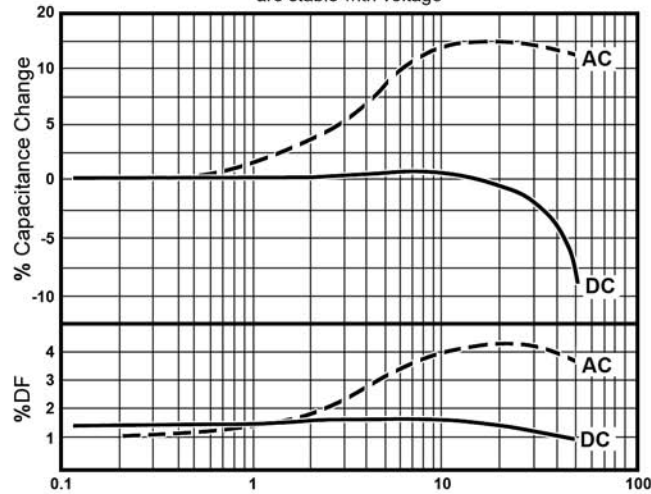

INTRODUCTION

MIL-PRF-123 specification covers the general requirements for high reliability, general purpose (BX) and temperature stable (BP) ceramic dielectric fixed capacitors for space, missile, and other high reliability applications. Capacitors covered by MIL-PRF-123 may be used in critical frequency determining applications, timing circuits, and other applications where absolute stability is required (BP) and in applications where appreciable variations in capacitance with respect to temperature, voltage, frequency, and life can be tolerated (BX).

SCREENING TESTS

Each lot has the following In-Process Inspections performed:

- 100% C-SAM (C-Mode Surface Acoustical Microscopy)
- In-Process Destructive Physical Analysis
- 100% visual inspection at a minimum of 10X magnification
- Pre-encapsulation terminal strength evaluation (leaded devices only). Radial leaded capacitors must meet a minimum lead pull of 1.8 kg (4.0 lbs.).

The following Group A shall be performed on each lot:

- Thermal Shock**—Performed in accordance to MIL-STD-202, Method 107, Condition A, with step 3 being 125°C. Number of cycles shall be 20 (100% of lot).
- Voltage Conditioning**—The voltage conditioning shall consist of applying twice the rated voltage to the units at the maximum rated temperature of 125°C for a minimum of 168 hours and a maximum of 264 hours. The voltage conditioning may be terminated at any time during 168 hours to 264 hours time interval that confirmed failures meet the requirements for the PDA during the last 48 hours listed in Table I below (100% of lot).

Optional Voltage Conditioning (Accelerated Voltage Conditioning)—All conditions of the standard voltage conditioning apply with the exception of the increased voltage and the decreased test time. (Refer to Mil-PRF-123 for formula.)

- *Step 5 is performed on chips at this point (100% of lot).
- Dielectric Withstanding Voltage** 250% of the dc rated voltage at 25°C (100% of lot).
 - Insulation Resistance**—The 25°C measurement with rated voltage applied shall be the lesser of 100 GΩ or 1000 megohm-microfarads (100% of lot).
 - ***Insulation Resistance**—The 125°C measurement with rated voltage applied shall be the lesser of 10 GΩ or 100 megohm-microfarads (1000% of lot). For chips 125°C IR is performed prior to step 3 above.
 - Storage** at 150°C for 2 hours minimum without voltage applied followed by a 12-hour minimum stabilization period (temperature characteristic BX only).
 - Capacitance** must be within specified tolerance at 25°C (100% of lot). **Cap Exclusion:** Capacitance values no more than 5% or .5 pF, whichever is greater, for BX characteristics or 1% or .3 pF, whichever is greater, for BP characteristics beyond specified tolerance limit shall be removed from the lot but shall not be considered defective for determination of the PDA.
 - Dissipation Factor** shall not exceed 2.5% for X dielectric, 0.15% for G dielectric at 25°C (100% of lot).
 - Percent Defective Allowable (PDA).** The following table lists the PDA requirements for MIL-PRF-123 Group A:

TABLE I

KEMET STYLE	MIL STYLE	BURN IN PDA LAST 48 HOURS	PDA OVERALL
C052Z	CKS05	1 unit or 0.1%	3%
C062Z	CKS06	1 unit or 0.2%	5%
C512Z	CKS07	1 unit or 0.2%	5%
C0805Z	CKS51	1 unit or 0.1%	3%
C1210Z	CKS52	1 unit or 0.1%	3%
C1808Z	CKS53	1 unit or 0.1%	3%
C2225Z	CKS54	1 unit or 0.1%	3%
C1206Z	CKS55	1 unit or 0.1%	3%
C1812Z	CKS56	1 unit or 0.1%	3%
C1825Z	CKS57	1 unit or 0.1%	3%

- Radiographic Inspection** (leaded devices only) (100% of lot).
- Visual Inspection** per MIL-PRF-123 criteria.
- Destructive Physical Analysis** per EIA-469 and MIL-PRF-123.

SAMPLE TESTS

The following Group B tests shall be performed on samples from each lot, which have been subjected to and have passed Group A inspection.

- Thermal Shock**—Performed in accordance to MIL-STD-202, Method 107, Condition A, with step 3 being 125°C. Number of cycles shall be 100.
- Life Test per MIL-5TD-202, Method 108.** Test temperature and tolerance is +125°C +4, -0°C. Capacitors shall be subjected to 2X rated voltage for 1000 hours.
- Humidity, steady state, low voltage per MIL-STD-202, Method 103, Condition A.** Capacitors shall be subjected to an environment of 85°C with 85% relative humidity for 240 hours minimum. Cycling shall not be performed. A dc potential of 1.3 ±0.25 volts shall be applied continuously through a 100,000 ohm resistance to each device under test. At completion, 25°C IR and Cap are read.
- Voltage-temperature limits**—Capacitance is measured at various temperatures (-55°C to +125°C) with and without rated voltage.
- Moisture Resistance per MIL-STD-202, Method 106.** There shall be 20 continuous cycles. During the first 10 cycles only, a dc potential of 50 volts shall be applied across the capacitor terminals. Once each day, a check shall be performed to determine whether a capacitor has shorted. Vibration cycle of MIL-STD-202, Method 106, Step 7b shall not be performed. Upon completion of MIL-STD-202, Method 106, Step 6 of the final cycle, capacitors shall be measured for capacitance, dielectric withstanding voltage and insulation resistance.

The following Group C tests shall be performed on samples selected from lots that have passed Group A and have been submitted for Group B inspection. Samples shall be selected every two months.

- Terminal Strength
- Solderability
- Resistance to Soldering Heat
- Solvent Resistance (Leaded devices only)

All lots shipped must have been subjected to and passed Group A and B testing.

STANDARD PACKAGING FOR MIL-PRF-123 IS AS FOLLOWS:

C052Z	tray	C0805Z	chip tray
C062Z	tray	C1206Z	chip tray
C512Z	1 pc. per bag	C1210Z	chip tray
		C1808Z	chip tray
		C1812Z	chip tray
		C1825Z	chip tray
		C2225Z	chip tray

DATA PACKAGE

A data package is sent with each shipment which contains:

- Summary of Group A testing
- Summary of Group B testing
- Group B Variables Test Data
- Lead Pull Data (Leaded Devices Only)
- Final Destructive Physical Analysis Report
- Certificate of Compliance stating that the ceramic capacitors supplied meet all the requirements of MIL-PRF-123, the applicable slash sheet(s) and all associated documents.

CAPACITOR OUTLINE DRAWINGS - (RADIAL LEADS)

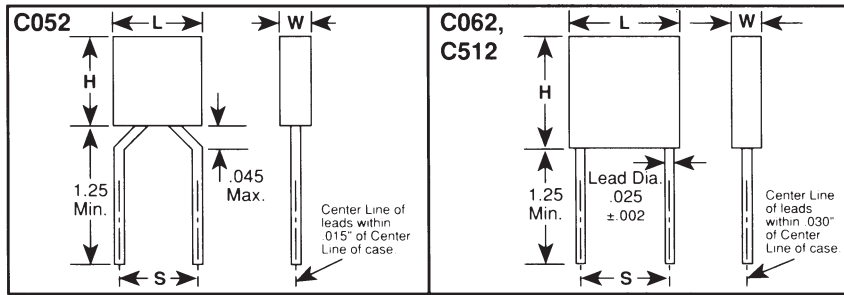

DIMENSIONS — INCHES & (MILLIMETERS)

CASE SIZE	MILITARY EQUIVALENT STYLES	H HEIGHT	L LENGTH	W WIDTH	S LEAD SPACING
C052	CKS05	.190 ± .010 (4.83 ± .25)	.190 ± .010 (4.83 ± .25)	.090 ± .010 (2.29 ± .25)	.200 ± .015 (5.08 ± .38)
C062	CKS06	.290 ± .010 (7.37 ± .25)	.290 ± .010 (7.37 ± .25)	.090 ± .010 (2.29 ± .25)	.200 ± .015 (5.08 ± .38)
C512	CKS07	.480 ± .020 (12.19 ± .51)	.480 ± .020 (12.19 ± .51)	.140 ± .010 (3.56 ± .25)*	.400 ± .020 (10.16 ± .51)

*0.200 maximum for some capacitance values.

ORDERING INFORMATION KEMET PART NUMBER

C 052 Z 102 K 5 G 5 C A

CERAMIC CASE SIZE — C

Radial
C052
C062
C512

SPECIFICATION — Z
Z — Mil-PRF-123

CAPACITANCE — 052
In picofarad code

CAPACITANCE TOLERANCE — 102
Standard
C — ±0.25 pF J — ±5%
D — ±0.5 pF K — ±10%
F — ±1%

WORKING VOLTAGE — K 5
5 — 50
1 — 100

FAILURE RATE — A
A — Standard — Not applicable

LEAD MATERIAL — C
C — Standard
Radial: solder coated copper

INTERNAL CONSTRUCTION — 5
5 — Standard

TEMPERATURE CHARACTERISTIC				
KEMET Designator	Military Equivalent	Temp. Range, °C	Capacitance Change With Temp.	
			Measured Without DC Bias Voltage	Measured With Bias (Rated) Voltage
G (Ultra Stable)	BP	-55 to +125	±30 ppm/°C	±30 ppm/°C
X (Stable)	BX	-55 to +125	±15%	+15% -25%

MIL-PRF-123 MILITARY PART NUMBER

M123 A 01 BX B 103 K C

MILITARY SPECIFICATION NUMBER

MODIFICATION LETTER
Indicates the latest characteristics of the part in the specification sheet.

MIL-PRF-123 SLASH SHEET NUMBER

Slash Sheet #	KEMET Style	Mil-C-123 Style
01	C052	CKS05
02	C062	CKS06
03	C512	CKS07

TERMINATION
Molded
C — Solder-coated copper (radial)

TOLERANCE
C—±0.25pF J—±5%
D—±0.5pF K—±10%
F—±1%

CAPACITANCE
In picofarad code

VOLTAGE
B=50 C=100

VOLTAGE-TEMPERATURE CHARACTERISTICS				
Capacitance Change With Temp.				
KEMET Designator	Military Equivalent	Temp. Range, °C	Measured Without DC Bias Voltage	Measured (Rated) With Bias Voltage
G (Ultra Stable)	BP	-55 to +125	±30 ppm/°C	±30 ppm/°C
X (Stable)	BX	-55 to +125	±15%	+15% -25%

RATINGS & PART NUMBER REFERENCE

CAP. pF	KEMET PART NUMBER	MIL-PRF-123 PART NUMBER
100 VOLT - BP - C052 SIZE (MILITARY CKS05)		
4.7	C052Z4791G5CA	M123A01BPC4R71C
5.1	C052Z5191G5CA	M123A01BPC5R11C
5.6	C052Z5691G5CA	M123A01BPC5R61C
6.2	C052Z6291G5CA	M123A01BPC6R21C
6.8	C052Z6891G5CA	M123A01BPC6R81C
7.5	C052Z7591G5CA	M123A01BPC7R51C
8.2	C052Z8291G5CA	M123A01BPC8R21C
9.1	C052Z9191G5CA	M123A01BPC9R11C
10	C052Z10021G5CA	M123A01BPC1002C
11	C052Z11021G5CA	M123A01BPC1102C
12	C052Z12021G5CA	M123A01BPC1202C
13	C052Z13021G5CA	M123A01BPC1302C
15	C052Z15021G5CA	M123A01BPC1502C
16	C052Z16021G5CA	M123A01BPC1602C
18	C052Z18021G5CA	M123A01BPC1802C
20	C052Z20021G5CA	M123A01BPC2002C
22	C052Z22021G5CA	M123A01BPC2202C
24	C052Z24021G5CA	M123A01BPC2402C
27	C052Z27031G5CA	M123A01BPC2703C
30	C052Z30031G5CA	M123A01BPC3003C
33	C052Z33031G5CA	M123A01BPC3303C
36	C052Z36031G5CA	M123A01BPC3603C
39	C052Z39031G5CA	M123A01BPC3903C
43	C052Z43031G5CA	M123A01BPC4303C
47	C052Z47031G5CA	M123A01BPC4703C
51	C052Z51031G5CA	M123A01BPC5103C
56	C052Z56031G5CA	M123A01BPC5603C
62	C052Z62031G5CA	M123A01BPC6203C
68	C052Z68031G5CA	M123A01BPC6803C
75	C052Z75031G5CA	M123A01BPC7503C
82	C052Z82031G5CA	M123A01BPC8203C
91	C052Z91031G5CA	M123A01BPC9103C
100	C052Z1011G5CA	M123A01BPC1011C
110	C052Z1111G5CA	M123A01BPC1111C
120	C052Z1211G5CA	M123A01BPC1211C
130	C052Z1311G5CA	M123A01BPC1311C
150	C052Z1511G5CA	M123A01BPC1511C
160	C052Z1611G5CA	M123A01BPC1611C
180	C052Z1811G5CA	M123A01BPC1811C
200	C052Z2011G5CA	M123A01BPC2011C
220	C052Z2211G5CA	M123A01BPC2211C
240	C052Z2411G5CA	M123A01BPC2411C
50 VOLT - BP - C052 SIZE (MILITARY CKS05)		
270	C052Z2715G5CA	M123A01BPB2715C
300	C052Z3015G5CA	M123A01BPB3015C
330	C052Z3315G5CA	M123A01BPB3315C
360	C052Z3615G5CA	M123A01BPB3615C
390	C052Z3915G5CA	M123A01BPB3915C
430	C052Z4315G5CA	M123A01BPB4315C
470	C052Z4715G5CA	M123A01BPB4715C
510	C052Z5115G5CA	M123A01BPB5115C

CAP. pF	KEMET PART NUMBER	MIL-PRF-123 PART NUMBER
50 VOLT - BP - C052 SIZE (MILITARY CKS05) (Cont'd)		
560	C052Z5615G5CA	M123A01BPB5615C
620	C052Z6215G5CA	M123A01BPB6215C
680	C052Z6815G5CA	M123A01BPB6815C
750	C052Z7515G5CA	M123A01BPB7515C
820	C052Z8215G5CA	M123A01BPB8215C
910	C052Z9115G5CA	M123A01BPB9115C
1,000	C052Z10215G5CA	M123A01BPB10215C
1,100	C052Z11215G5CA	M123A01BPB11215C
1,200	C052Z12215G5CA	M123A01BPB12215C
1,300	C052Z13215G5CA	M123A01BPB13215C
1,500	C052Z15215G5CA	M123A01BPB15215C
1,600	C052Z16215G5CA	M123A01BPB16215C
1,800	C052Z18215G5CA	M123A01BPB18215C
2,000	C052Z20215G5CA	M123A01BPB20215C
2,200	C052Z22215G5CA	M123A01BPB22215C
2,400	C052Z24215G5CA	M123A01BPB24215C
2,700	C052Z27215G5CA	M123A01BPB27215C
100 VOLT - BP - C062 SIZE (MILITARY CKS06)		
270	C062Z2711G5CA	M123A02BPC2711C
300	C062Z3011G5CA	M123A02BPC3011C
330	C062Z3311G5CA	M123A02BPC3311C
360	C062Z3611G5CA	M123A02BPC3611C
390	C062Z3911G5CA	M123A02BPC3911C
430	C062Z4311G5CA	M123A02BPC4311C
470	C062Z4711G5CA	M123A02BPC4711C
510	C062Z5111G5CA	M123A02BPC5111C
560	C062Z5611G5CA	M123A02BPC5611C
620	C062Z6211G5CA	M123A02BPC6211C
680	C062Z6811G5CA	M123A02BPC6811C
750	C062Z7511G5CA	M123A02BPC7511C
820	C062Z8211G5CA	M123A02BPC8211C
910	C062Z9111G5CA	M123A02BPC9111C
1,000	C062Z10211G5CA	M123A02BPC10211C
1,100	C062Z11211G5CA	M123A02BPC11211C
1,200	C062Z12211G5CA	M123A02BPC12211C
1,300	C062Z13211G5CA	M123A02BPC13211C
1,500	C062Z15211G5CA	M123A02BPC15211C
1,600	C062Z16211G5CA	M123A02BPC16211C
1,800	C062Z18211G5CA	M123A02BPC18211C
2,000	C062Z20211G5CA	M123A02BPC20211C
2,200	C062Z22211G5CA	M123A02BPC22211C
2,400	C062Z24211G5CA	M123A02BPC24211C
50 VOLT - BP - C062 SIZE (MILITARY CKS06)		
2,700	C062Z27215G5CA	M123A02BPB27215C
3,000	C062Z30215G5CA	M123A02BPB30215C
3,300	C062Z33215G5CA	M123A02BPB33215C
3,600	C062Z36215G5CA	M123A02BPB36215C
3,900	C062Z39215G5CA	M123A02BPB39215C
4,300	C062Z43215G5CA	M123A02BPB43215C
4,700	C062Z47215G5CA	M123A02BPB47215C

To complete the part numbers, insert the following tolerances: (1) C, ±0.25pF; D, ±0.5pF (2) C, ±0.25pF; J, ±5%; K, ±10% (3) F, ±1%; J, ±5%; K, ±10%

RATINGS & PART NUMBER REFERENCE

CAP. pF	KEMET PART NUMBER	MIL-PRF-123 PART NUMBER
100 VOLT - BP - C512 SIZE (MILITARY CKS07)		
2,700	C512Z272G1G5CA	M123A03BPC272G
3,000	C512Z302G1G5CA	M123A03BPC302G
3,300	C512Z332G1G5CA	M123A03BPC332G
3,600	C512Z362G1G5CA	M123A03BPC362G
3,900	C512Z392G1G5CA	M123A03BPC392G
4,300	C512Z432G1G5CA	M123A03BPC432G
4,700	C512Z472G1G5CA	M123A03BPC472G
5,100	C512Z512G1G5CA	M123A03BPC512G
5,600	C512Z562G1G5CA	M123A03BPC562G
6,200	C512Z622G1G5CA	M123A03BPC622G
6,800	C512Z682G1G5CA	M123A03BPC682G
7,500	C512Z752G1G5CA	M123A03BPC752G
8,200	C512Z822G1G5CA	M123A03BPC822G
9,100	C512Z912G1G5CA	M123A03BPC912G
10,000	C512Z103G1G5CA	M123A03BPC103G
50 VOLT - BP - C512 SIZE (MILITARY CKS07)		
11,000	C512Z113G5G5CA	M123A03BPB113G
12,000	C512Z123G5G5CA	M123A03BPB123G
13,000	C512Z133G5G5CA	M123A03BPB133G
15,000	C512Z153G5G5CA	M123A03BPB153G
16,000	C512Z163G5G5CA	M123A03BPB163G
18,000	C512Z183G5G5CA	M123A03BPB183G
20,000	C512Z203G5G5CA	M123A03BPB203G
22,000	C512Z223G5G5CA	M123A03BPB223G
24,000	C512Z243G5G5CA	M123A03BPB243G
27,000	C512Z273G5G5CA	M123A03BPB273G
30,000	C512Z303G5G5CA	M123A03BPB303G
33,000	C512Z333G5G5CA	M123A03BPB333G
36,000	C512Z363G5G5CA	M123A03BPB363G
39,000	C512Z393G5G5CA	M123A03BPB393G
43,000	C512Z433G5G5CA	M123A03BPB433G
47,000	C512Z473G5G5CA	M123A03BPB473G
51,000	C512Z513G5G5CA	M123A03BPB513G
56,000	C512Z563G5G5CA	M123A03BPB563G
62,000	C512Z623G5G5CA	M123A03BPB623G
68,000	C512Z683G5G5CA	M123A03BPB683G
75,000	C512Z753G5G5CA	M123A03BPB753G
82,000	C512Z823G5G5CA	M123A03BPB823G
91,000	C512Z913G5G5CA	M123A03BPB913G
100,000	C512Z104G5G5CA	M123A03BPB104G

CAP. pF	KEMET PART NUMBER	MIL-PRF-123 PART NUMBER
100 VOLT - BX - C062 SIZE (MILITARY CKS06)		
5,600	C062Z562K1X5CA	M123A02BXC562KC
6,800	C062Z682K1X5CA	M123A02BXC682KC
8,200	C062Z822K1X5CA	M123A02BXC822KC
10,000	C062Z103K1X5CA	M123A02BXC103KC
12,000	C062Z123K1X5CA	M123A02BXC123KC
15,000	C062Z153K1X5CA	M123A02BXC153KC
18,000	C062Z183K1X5CA	M123A02BXC183KC
22,000	C062Z223K1X5CA	M123A02BXC223KC
27,000	C062Z273K1X5CA	M123A02BXC273KC
33,000	C062Z333K1X5CA	M123A02BXC333KC
39,000	C062Z393K1X5CA	M123A02BXC393KC
47,000	C062Z473K1X5CA	M123A02BXC473KC
56,000	C062Z563K1X5CA	M123A02BXC563KC
68,000	C062Z683K1X5CA	M123A02BXC683KC
82,000	C062Z823K1X5CA	M123A02BXC823KC
100,000	C062Z104K1X5CA	M123A02BXC104KC
50 VOLT - BX - C062 SIZE (MILITARY CKS06)		
56,000	C062Z563K5X5CA	M123A02BXC563KC
68,000	C062Z683K5X5CA	M123A02BXC683KC
82,000	C062Z823K5X5CA	M123A02BXC823KC
100,000	C062Z104K5X5CA	M123A02BXC104KC
120,000	C062Z124K5X5CA	M123A02BXC124KC
150,000	C062Z154K5X5CA	M123A02BXC154KC
180,000	C062Z184K5X5CA	M123A02BXC184KC
220,000	C062Z224K5X5CA	M123A02BXC224KC
270,000	C062Z274K5X5CA	M123A02BXC274KC
330,000	C062Z334K5X5CA	M123A02BXC334KC
390,000	C062Z394K5X5CA	M123A02BXC394KC
470,000	C062Z474K5X5CA	M123A02BXC474KC
560,000	C062Z564K5X5CA	M123A02BXC564KC
680,000	C062Z684K5X5CA	M123A02BXC684KC
820,000	C062Z824K5X5CA	M123A02BXC824KC
1,000,000	C062Z105K5X5CA	M123A02BXC105KC

CAP. pF	KEMET PART NUMBER	MIL-PRF-123 PART NUMBER
100 VOLT - BX - C052 SIZE (MILITARY CKS05)		
270	C052Z271K1X5CA	M123A01BXC271KC
330	C052Z331K1X5CA	M123A01BXC331KC
390	C052Z391K1X5CA	M123A01BXC391KC
470	C052Z471K1X5CA	M123A01BXC471KC
560	C052Z561K1X5CA	M123A01BXC561KC
680	C052Z681K1X5CA	M123A01BXC681KC
820	C052Z821K1X5CA	M123A01BXC821KC
1,000	C052Z102K1X5CA	M123A01BXC102KC
1,200	C052Z122K1X5CA	M123A01BXC122KC
1,500	C052Z152K1X5CA	M123A01BXC152KC
1,800	C052Z182K1X5CA	M123A01BXC182KC
2,200	C052Z222K1X5CA	M123A01BXC222KC
2,700	C052Z272K1X5CA	M123A01BXC272KC
3,300	C052Z332K1X5CA	M123A01BXC332KC
3,900	C052Z392K1X5CA	M123A01BXC392KC
4,700	C052Z472K1X5CA	M123A01BXC472KC
50 VOLT - BX - C052 SIZE (MILITARY CKS05)		
5,600	C052Z562K5X5CA	M123A01BXC562KC
6,800	C052Z682K5X5CA	M123A01BXC682KC
8,200	C052Z822K5X5CA	M123A01BXC822KC
10,000	C052Z103K5X5CA	M123A01BXC103KC

CAP. pF	KEMET PART NUMBER	MIL-PRF-123 PART NUMBER
100 VOLT - BX - C512 SIZE (MILITARY CKS07)		
56,000	C512Z563K1X5CA	M123A03BXC563KC
68,000	C512Z683K1X5CA	M123A03BXC683KC
82,000	C512Z823K1X5CA	M123A03BXC823KC
100,000	C512Z104K1X5CA	M123A03BXC104KC
120,000	C512Z124K1X5CA	M123A03BXC124KC
150,000	C512Z154K1X5CA	M123A03BXC154KC
180,000	C512Z184K1X5CA	M123A03BXC184KC
220,000	C512Z224K1X5CA	M123A03BXC224KC
270,000	C512Z274K1X5CA	M123A03BXC274KC
330,000	C512Z334K1X5CA	M123A03BXC334KC
390,000	C512Z394K1X5CA	M123A03BXC394KC
470,000	C512Z474K1X5CA	M123A03BXC474KC
50 VOLT - BX - C512 SIZE (MILITARY CKS07)		
560,000	C512Z564K5X5CA	M123A03BXC564KC
680,000	C512Z684K5X5CA	M123A03BXC684KC
820,000	C512Z824K5X5CA	M123A03BXC824KC
1,000,000	C512Z105K5X5CA	M123A03BXC105KC

To complete the part numbers, insert the following tolerances: (1) C, ±0.25pF; D, ±0.5pF (2) C, ±0.25pF; J, ±5%; K, ±10% (3) F, ±1%; J, ±5%; K, ±10%

MARKING INFORMATION

C052Z
M123A
01BPC
4R7CC
MIL-PRF-123
Part Number

C062Z, C512Z
M123A
02BPC
271FC
JAN
MIL-PRF-123
Part Number
"JAN"

CAGE =
Commercial and
Government Entity

JAN
XXXX*
31433
— "JAN"
— Date Lot Code
— CAGE

271F
100V
XXXX*
31433
— Capacitance Code & Tolerance
— Voltage
— Date Lot Code
— CAGE

CAPACITOR OUTLINE DRAWINGS

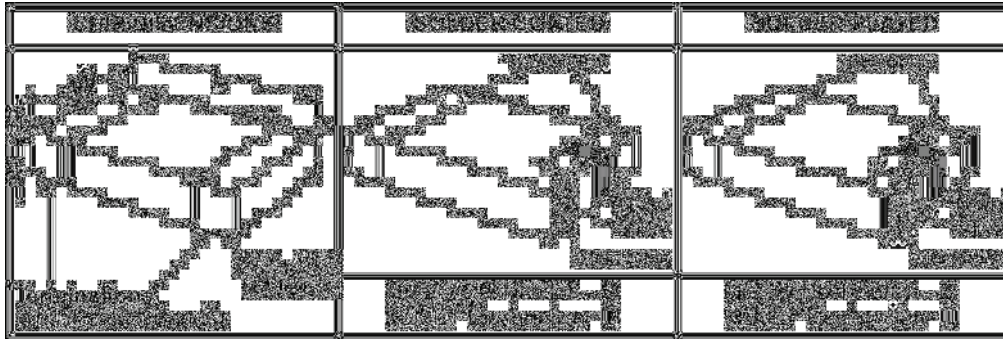

Note: For solder coated termination, add 0.015" (0.38mm) to the positive width and thickness tolerances. Add the following to the positive length tolerance: CKS51 - 0.020" (0.51mm); CKS52, CKS53 and CKS54 - 0.025" (0.64mm); add 0.012" (0.30mm) to the bandwidth tolerance.

DIMENSIONS — INCHES

Chip Size	Military Equivalent Styles	L Length	W Width	T Thickness Maximum
0805	CKS51	0.080 ± 0.015	0.050 ± 0.015	0.055
1210	CKS52	0.120 ± 0.015	0.100 ± 0.015	0.065
1808	CKS53	0.180 ± 0.015	0.080 ± 0.015	0.065
2225	CKS54	0.220 ± 0.015	0.250 ± 0.015	0.070
1206	CKS55	0.120 ± 0.015	0.060 ± 0.015	0.065
1812	CKS56	0.180 ± 0.015	0.125 ± 0.015	0.080
1825	CKS57	0.180 ± 0.015	0.250 ± 0.015	0.080

MARKING

Capacitors shall be legibly laser marked in contrasting color with the KEMET trademark and 2-digit capacitance symbol.

ORDERING INFORMATION

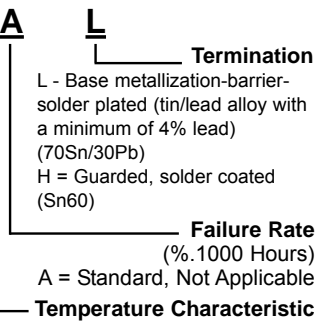
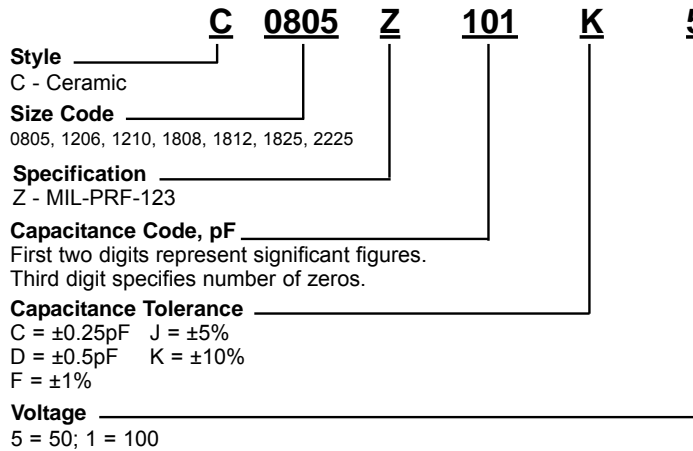

KEMET Designator	Military Equivalent	Temp. Range, °C	Measured Without DC Bias Voltage	Measured With Bias (Rated Voltage)
G (UltraStable)	BP	-55 to 125	±30 ppm°C	±30 ppm°C
X (Stable)	BX	-55 to +125	±15%	+15% -25%

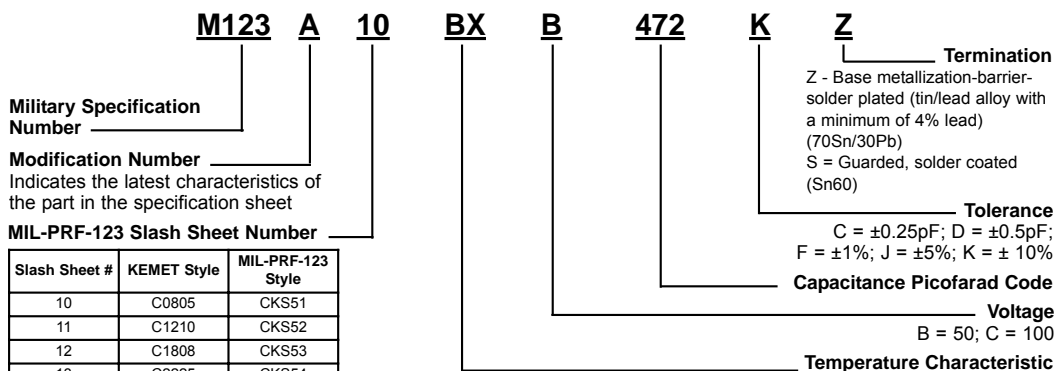

KEMET Designator	Military Equivalent	Temp. Range, °C	Capacitance Change with Temperature	
			Measured Without DC Bias Voltage	Measured With Bias (Rated Voltage)
G (UltraStable)	BP	-55 to 125	±30 ppm°C	±30 ppm°C
X (Stable)	BX	-55 to +125	±15%	+15% -25%

RATINGS AND PART NUMBER REFERENCE

CAP. pF	KEMET PART NUMBER	MIL-PRF-123 PART NUMBER
100 VOLT - BP - C1206 SIZE (MILITARY CKS55)		
1.0	C1206Z109(4)1GAL	M123A21BPC1R0(4)Z
1.1	C1206Z119(4)1GAL	M123A21BPC1R1(4)Z
1.2	C1206Z129(4)1GAL	M123A21BPC1R2(4)Z
1.3	C1206Z139(4)1GAL	M123A21BPC1R3(4)Z
1.5	C1206Z159(4)1GAL	M123A21BPC1R5(4)Z
1.6	C1206Z169(4)1GAL	M123A21BPC1R6(4)Z
1.8	C1206Z189(4)1GAL	M123A21BPC1R8(4)Z
2.0	C1206Z209(4)1GAL	M123A21BPC2R0(4)Z
2.2	C1206Z229(4)1GAL	M123A21BPC2R2(4)Z
2.4	C1206Z249(4)1GAL	M123A21BPC2R4(4)Z
2.7	C1206Z279(5)1GAL	M123A21BPC2R7(5)Z
3.0	C1206Z309(5)1GAL	M123A21BPC3R0(5)Z
3.3	C1206Z339(5)1GAL	M123A21BPC3R3(5)Z
3.6	C1206Z369(5)1GAL	M123A21BPC3R6(5)Z
3.9	C1206Z399(5)1GAL	M123A21BPC3R9(5)Z
4.3	C1206Z439(5)1GAL	M123A21BPC4R3(5)Z
4.7	C1206Z479(5)1GAL	M123A21BPC4R7(5)Z
5.1	C1206Z519(5)1GAL	M123A21BPC5R1(5)Z
5.6	C1206Z569(5)1GAL	M123A21BPC5R6(5)Z
6.2	C1206Z629(5)1GAL	M123A21BPC6R2(5)Z
6.8	C1206Z689(5)1GAL	M123A21BPC6R8(5)Z
7.5	C1206Z759(5)1GAL	M123A21BPC7R5(5)Z
8.2	C1206Z829(5)1GAL	M123A21BPC8R2(5)Z
9.1	C1206Z919(5)1GAL	M123A21BPC9R1(5)Z
10.0	C1206Z100(3)1GAL	M123A21BPC100(3)Z
11.0	C1206Z110(3)1GAL	M123A21BPC110(3)Z
12.0	C1206Z120(3)1GAL	M123A21BPC120(3)Z
13.0	C1206Z130(3)1GAL	M123A21BPC130(3)Z
15.0	C1206Z150(3)1GAL	M123A21BPC150(3)Z
16.0	C1206Z160(3)1GAL	M123A21BPC160(3)Z
18.0	C1206Z180(3)1GAL	M123A21BPC180(3)Z
20.0	C1206Z200(3)1GAL	M123A21BPC200(3)Z
24.0	C1206Z240(3)1GAL	M123A21BPC240(3)Z
27.0	C1206Z270(3)1GAL	M123A21BPC270(3)Z
33.0	C1206Z330(3)1GAL	M123A21BPC330(3)Z
36.0	C1206Z360(3)1GAL	M123A21BPC360(3)Z
39.0	C1206Z390(3)1GAL	M123A21BPC390(3)Z
43.0	C1206Z430(3)1GAL	M123A21BPC430(3)Z
47.0	C1206Z470(3)1GAL	M123A21BPC470(3)Z
51.0	C1206Z510(3)1GAL	M123A21BPC510(3)Z
56.0	C1206Z560(3)1GAL	M123A21BPC560(3)Z
62.0	C1206Z620(3)1GAL	M123A21BPC620(3)Z
68.0	C1206Z680(3)1GAL	M123A21BPC680(3)Z
75.0	C1206Z750(3)1GAL	M123A21BPC750(3)Z
82.0	C1206Z820(3)1GAL	M123A21BPC820(3)Z
91.0	C1206Z910(3)1GAL	M123A21BPC910(3)Z
100.0	C1206Z101(3)1GAL	M123A21BPC101(3)Z
110.0	C1206Z111(3)1GAL	M123A21BPC111(3)Z
120.0	C1206Z121(3)1GAL	M123A21BPC121(3)Z
130.0	C1206Z131(3)1GAL	M123A21BPC131(3)Z
150.0	C1206Z151(3)1GAL	M123A21BPC151(3)Z
160.0	C1206Z161(3)1GAL	M123A21BPC161(3)Z
180.0	C1206Z181(3)1GAL	M123A21BPC181(3)Z
200.0	C1206Z201(3)1GAL	M123A21BPC201(3)Z
220.0	C1206Z221(3)1GAL	M123A21BPC221(3)Z
240.0	C1206Z241(3)1GAL	M123A21BPC241(3)Z
270.0	C1206Z271(3)1GAL	M123A21BPC271(3)Z
300.0	C1206Z301(3)1GAL	M123A21BPC301(3)Z
330.0	C1206Z331(3)1GAL	M123A21BPC331(3)Z
360.0	C1206Z361(3)1GAL	M123A21BPC361(3)Z
390.0	C1206Z391(3)1GAL	M123A21BPC391(3)Z
430.0	C1206Z431(3)1GAL	M123A21BPC431(3)Z
470.0	C1206Z471(3)1GAL	M123A21BPC471(3)Z
510.0	C1206Z511(3)1GAL	M123A21BPC511(3)Z
560.0	C1206Z561(3)1GAL	M123A21BPC561(3)Z
620.0	C1206Z621(3)1GAL	M123A21BPC621(3)Z
680.0	C1206Z681(3)1GAL	M123A21BPC681(3)Z
750.0	C1206Z751(3)1GAL	M123A21BPC751(3)Z
820.0	C1206Z821(3)1GAL	M123A21BPC821(3)Z
910.0	C1206Z911(3)1GAL	M123A21BPC911(3)Z
1000.0	C1206Z102(3)1GAL	M123A21BPC102(3)Z

CAP. pF	KEMET PART NUMBER	MIL-PRF-123 PART NUMBER
50 VOLT-BP-C1206 SIZE (MILITARY CKS55)		
1,100.0	C1206Z112(3)5GAL	M123A21BPB112(3)Z
1,200.0	C1206Z122(3)5GAL	M123A21BPB122(3)Z
1,300.0	C1206Z132(3)5GAL	M123A21BPB132(3)Z
1,500.0	C1206Z152(3)5GAL	M123A21BPB152(3)Z
1,600.0	C1206Z162(3)5GAL	M123A21BPB162(3)Z
1,800.0	C1206Z182(3)5GAL	M123A21BPB182(3)Z
2,000.0	C1206Z202(3)5GAL	M123A21BPB202(3)Z
2,200.0	C1206Z222(3)5GAL	M123A21BPB222(3)Z
100 VOLT-BX-C1206 SIZE (MILITARY CKS55)		
4,700.0	C1206Z472(6)1XAL	M123A21BXC472(6)Z
5,600.0	C1206Z562(6)1XAL	M123A21BXC562(6)Z
6,800.0	C1206Z682(6)1XAL	M123A21BXC682(6)Z
8,200.0	C1206Z822(6)1XAL	M123A21BXC822(6)Z
10,000.0	C1206Z103(6)1XAL	M123A21BXC103(6)Z
12,000.0	C1206Z123(6)1XAL	M123A21BXC123(6)Z
15,000.0	C1206Z153(6)1XAL	M123A21BXC153(6)Z
50 VOLT-BX-C1206 SIZE (MILITARY CKS55)		
18,000.0	C1206Z183(6)5XAL	M123A21BXB183(6)Z
22,000.0	C1206Z223(6)5XAL	M123A21BXB223(6)Z
27,000.0	C1206Z273(6)5XAL	M123A21BXB273(6)Z
33,000.0	C1206Z333(6)5XAL	M123A21BXB333(6)Z
39,000.0	C1206Z393(6)5XAL	M123A21BXB393(6)Z
100 VOLT-BP-C1812 SIZE (MILITARY CKS56)		
1,200.0	C1812Z122(3)1GAL	M123A22BPC122(3)Z
2,200.0	C1812Z222(3)1GAL	M123A22BPC222(3)Z
2,400.0	C1812Z242(3)1GAL	M123A22BPC242(3)Z
2,700.0	C1812Z272(3)1GAL	M123A22BPC272(3)Z
3,000.0	C1812Z302(3)1GAL	M123A22BPC302(3)Z
3,300.0	C1812Z332(3)1GAL	M123A22BPC332(3)Z
3,600.0	C1812Z362(3)1GAL	M123A22BPC362(3)Z
3,900.0	C1812Z392(3)1GAL	M123A22BPC392(3)Z
4,300.0	C1812Z432(3)1GAL	M123A22BPC432(3)Z
4,700.0	C1812Z472(3)1GAL	M123A22BPC472(3)Z
50 VOLT-BP-C1812 SIZE (MILITARY CKS56)		
5,100.0	C1812Z512(3)5GAL	M123A22BPB512(3)Z
5,600.0	C1812Z562(3)5GAL	M123A22BPB562(3)Z
6,200.0	C1812Z622(3)5GAL	M123A22BPB622(3)Z
6,800.0	C1812Z682(3)5GAL	M123A22BPB682(3)Z
7,500.0	C1812Z752(3)5GAL	M123A22BPB752(3)Z
8,200.0	C1812Z822(3)5GAL	M123A22BPB822(3)Z
9,100.0	C1812Z912(3)5GAL	M123A22BPB912(3)Z
10,000.0	C1812Z103(3)5GAL	M123A22BPB103(3)Z
100 VOLT-BX-C1812 SIZE (MILITARY CKS56)		
27,000.0	C1812Z273(6)1XAL	M123A22BXC273(6)Z
33,000.0	C1812Z333(6)1XAL	M123A22BXC333(6)Z
39,000.0	C1812Z393(6)1XAL	M123A22BXC393(6)Z
47,000.0	C1812Z473(6)1XAL	M123A22BXC473(6)Z
56,000.0	C1812Z563(6)1XAL	M123A22BXC563(6)Z
50 VOLT-BX-C1812 SIZE (MILITARY CKS56)		
100,000.0	C1812Z104(6)5XAL	M123A22BXB104(6)Z
120,000.0	C1812Z124(6)5XAL	M123A22BXB124(6)Z
150,000.0	C1812Z154(6)5XAL	M123A22BXB154(6)Z
180,000.0	C1812Z184(6)5XAL	M123A22BXB184(6)Z

CAP. pF	KEMET PART NUMBER	MIL-PRF-123 PART NUMBER
100 VOLT-BP-C1825 SIZE (MILITARY CKS57)		
3,900.0	C1825Z392(3)1GAL	M123A23BPC392(3)Z
4,700.0	C1825Z472(3)1GAL	M123A23BPC472(3)Z
5,100.0	C1825Z512(3)1GAL	M123A23BPC512(3)Z
5,600.0	C1825Z562(3)1GAL	M123A23BPC562(3)Z
6,200.0	C1825Z622(3)1GAL	M123A23BPC622(3)Z
6,800.0	C1825Z682(3)1GAL	M123A23BPC682(3)Z
7,500.0	C1825Z752(3)1GAL	M123A23BPC752(3)Z
8,200.0	C1825Z822(3)1GAL	M123A23BPC822(3)Z
9,100.0	C1825Z912(3)1GAL	M123A23BPC912(3)Z
10,000.0	C1825Z103(3)1GAL	M123A23BPC103(3)Z
50 VOLT-BP-C1812 SIZE (MILITARY CKS57)		
11,000.0	C1825Z113(3)5GAL	M123A23BPB113(3)Z
12,000.0	C1825Z123(3)5GAL	M123A23BPB123(3)Z
13,000.0	C1825Z133(3)5GAL	M123A23BPB133(3)Z
15,000.0	C1825Z153(3)5GAL	M123A23BPB153(3)Z
16,000.0	C1825Z163(3)5GAL	M123A23BPB163(3)Z
18,000.0	C1825Z183(3)5GAL	M123A23BPB183(3)Z
20,000.0	C1825Z203(3)5GAL	M123A23BPB203(3)Z
22,000.0	C1825Z223(3)5GAL	M123A23BPB223(3)Z
100 VOLT-BX-C1825 SIZE (MILITARY CKS57)		
56,000.0	C1825Z563(6)1XAL	M123A23BXC563(6)Z
68,000.0	C1825Z683(6)1XAL	M123A23BXC683(6)Z
82,000.0	C1825Z823(6)1XAL	M123A23BXC823(6)Z
100,000.0	C1825Z104(6)1XAL	M123A23BXC104(6)Z
120,000.0	C1825Z124(6)1XAL	M123A23BXC124(6)Z
150,000.0	C1825Z154(6)1XAL	M123A23BXC154(6)Z
50 VOLT-BX-C1825 SIZE (MILITARY CKS57)		
180,000.0	C1825Z184(6)5XAL	M123A23BXB184(6)Z
220,000.0	C1825Z224(6)5XAL	M123A23BXB224(6)Z
270,000.0	C1825Z274(6)5XAL	M123A23BXB274(6)Z
330,000.0	C1825Z334(6)5XAL	M123A23BXB334(6)Z
390,000.0	C1825Z394(6)5XAL	M123A23BXB394(6)Z
470,000.0	C1825Z474(6)5XAL	M123A23BXB474(6)Z

To complete the KEMET part numbers, insert the following tolerances:

- (1) C = ±0.25pF; D = ±0.5pF
- (2) C = ±0.25pF; J = ±5%; K = ±10%
- (3) F = ±1%; J = ±5%; K = ±10%
- (4) B = ±0.1pF; C = ±0.25pF%
- (5) B = ±0.1pF; C = ±0.25pF; D = ±0.50pF
- (6) K = ±10%; M = ±20%

To complete the KEMET part numbers, insert the following voltage:

- (7) B = 50 volts; C = 100 volts
- (8) 5 = 50 volts; 1 = 100volts

HIGH RELIABILITY — GR900

GR900 capacitors are intended for use in any application where the chance of failure must be reduced to the lowest possible level. While any well-made multilayer ceramic capacitor is an inherently reliable device, GR900 capacitors receive special attention in all phases of manufacture including:

- Raw Materials Selection
- Special Designs
- Clean Room Production
- Individual Batch Testing
- C-SAM (when applicable)
- Singular Batch Identity is Maintained
- Destructive Physical Analysis

These parts are well worth the added investment in comparison to the cost of a device or system failure.

Typical applications include:

Medical, Aerospace, Communication Satellites, Radar, Guidance Systems.

SCREENING AND SAMPLE TESTS

Each batch receives the following testing/inspections:

Preliminary:

1. **Destructive Physical Analysis: (DPA)** - A sample is pulled from each lot and examined per EIA-469 and KEMET's strict internal void and delamination criteria. Sampling plan is per MIL-PRF-123.

2. **C-SAM** - May be performed on batches failing to meet the DPA criteria for removal of marginal product. Not required on each lot.

Group A

1. **Thermal Shock** — Materials used in the construction of multilayer ceramic capacitors possess various thermal coefficients of expansion. To assure maximum uniformity, each part is temperature cycled in accordance to MIL-STD-202, Method 107, Condition A with Step 3 being 125°C. Number of cycles shall be 20 (100% of lot).

2. **Voltage Conditioning** — One of the most strenuous environments for any capacitor is the high temperature/high voltage test. All units are subject to twice-rated voltage to the units at the maximum rated temperature of 125°C for a minimum of 168 hours and a maximum of 264 hours. The voltage conditioning may be terminated at any time during 168 hours to 264 hours time interval that confirmed failures meet the requirements of the PDA during the last 48 hours of 1 unit or .4% (100% of lot).

Optional Voltage Conditioning (Accelerated Voltage Conditioning) — All conditions of the standard voltage conditioning apply with the exception of increased voltage and decreased test time. Refer to MIL-PRF-123 for the proper formula.

***Step 5 is performed on chips at this point (100% of lot).**

3. **Dielectric Withstanding Voltage** — 250% of the dc rated voltage at 25°C (100% of lot).

4. **Insulation Resistance** — The 25°C measurement with rated voltage applied shall be the lesser of 100 GΩ or 1000 megohm-microfarads (100% of lot).

*5. **Insulation Resistance** — The 125°C measurement with rated voltage applied shall be the lesser of 10 GΩ or 100 megohm-microfarads (100% of lot). For chips, 125°C IR is performed prior to Step 3 above.

6. **Storage** at 150°C for 2 hours minimum without voltage applied followed by a 12-hour minimum stabilization period (temperature characteristic BX only).

7. **Capacitance** — Shall be within specified tolerance at 25°C (100% of lot). (Aging phenomenon is taken into account for BX dielectric to obtain capacitance.)

8. **Dissipation Factor** — Shall not exceed 2.5% for X7R (BX) dielectric, 0.15% for C0G (BP) dielectric at 25°C. (100% of lot.)

9. **Percent Defective Allowable (PDA)** — The overall PDA is 8% for parts outside the MIL-PRF-123 values. The PDA is per MIL-PRF-123 for all parts that are valid MIL-PRF-123 values. The PD includes steps 1 through 8 above with the following exceptions. Capacitance exclusion - capacitance values no more than 5% or .5pF, whichever is greater for BX characteristic or 1% or .3pF, whichever is greater for BP characteristic beyond specified tolerance limit, shall be removed from the lot but shall not be considered defective for determination of the PD.

Insulation Resistance at 25°C — Product which is not acceptable for twice the military limit but is acceptable per the military limit, is removed from the lot but shall not be considered defective for determination of the PD.

10. **Visual and Mechanical Examination** — Performed per MIL-PRF-123 criteria.

11. **Radiographic Examination (Leaded Devices Only)** — Radial devices receive a one-plane X-ray.

12. **Destructive Physical Analysis (DPA)** — A sample is examined on each lot per EIA-469. Sampling Plan is per MIL-PRF-123.

STANDARD PACKAGING

All products are packaged in trays except C512 capacitors which are packaged 1 piece per bag.

DATA PACKAGE

A data package is sent with each shipment which contains:

1. Final Destructive Physical Analysis (DPA) report.
2. Certificate of Compliance stating that the parts meet all applicable requirements of the appropriate military specification to the best failure level to which KEMET is approved.
3. Summary of Group A Testing.

CAPACITOR OUTLINE DRAWINGS

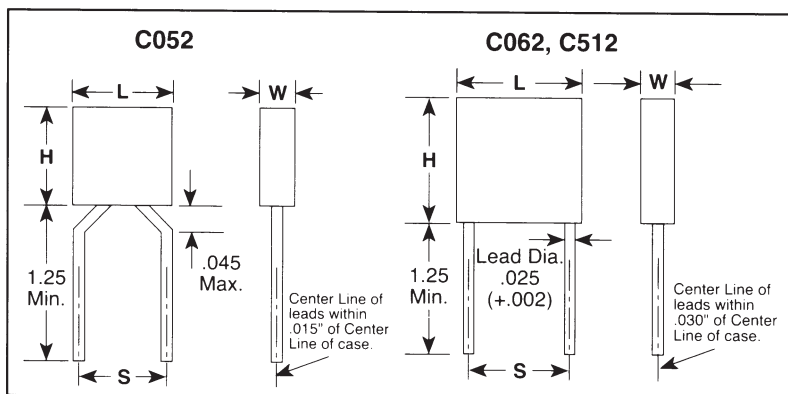

DIMENSIONS — INCHES & (MILLIMETERS) RADIAL LEAD

KEMET CASE SIZE	H HEIGHT	L LENGTH	W WIDTH	S LEAD SPACING	MILITARY STYLES		
					MIL-PRF-20	MIL-PRF-39014	MIL-PRF-123
C052	.190 ± .010 (4.83 ± .25)	.190 ± .010 (4.83 ± .25)	.090 ± .010 (2.29 ± .25)	.200 ± .015 (5.08 ± .38)	CCR05	CKR05	CKS05
C062	.290 ± .010 (7.37 ± .25)	.290 ± .010 (7.37 ± .25)	.090 ± .010 (2.29 ± .25)	.200 ± .015 (5.08 ± .38)	CCR06	CKR06	CKS06
C512	.480 ± .020 (12.19 ± .51)	.480 ± .020 (12.19 ± .51)	.140 ± .010 (3.56 ± .25)	.400 ± .020 (10.16 ± .51)	CCR07	—	CKS07

C 052 B 223 K 1 X 5 C A

MONOLITHIC CERAMIC CAPACITORS

PHYSICAL DIMENSIONS
(See above)

HI REL SPECIFICATIONS APPLY:
B—Leaded devices

CAPACITANCE PICOFARAD CODE
First two digits are significant figures of capacitance value and third digit is the number of zeros to follow in stating capacitance in picofarads. For example, "223" is 22,000 pF. The third-digit number "9" indicates a divisor of 10; for example, "229" is 2.2 pF.

CAPACITANCE TOLERANCE
M — ±20% G — ±2% (G(BP) Temperature Characteristic Only)
K — ±10% F — ±1% (G(BP) Temperature Characteristic Only)
J — ±5% *D—±0.5 pF (G(BP) Temperature Characteristic Only)
 *C—±0.25 pF (G(BP) Temperature Characteristic Only)

FAILURE RATE
A—Standard — Not Applicable

LEAD MATERIAL
C — Standard —
Radial: solder coated copper

INTERNAL CONSTRUCTION
5— Standard

TEMPERATURE CHARACTERISTICS
(See table below)

RATED VOLTAGE
1 — 100
2 — 200
5 — 50

*These tolerances available only for 1.0 through 9.1 pF capacitors.

TEMPERATURE CHARACTERISTICS CAPACITANCE CHANGE WITH TEMPERATURE -55° TO +125°C

PART NUMBER LETTER	WITHOUT D.C. BIAS	WITH RATED D.C. VOLTAGE APPLIED	OTHER NOMENCLATURE		
			EIA	MILITARY	COMMON
G	±30ppm/°C	±30ppm/°C	COG	CG,BP	NPO
X	±15%	+15%, -25%	X7R	BX	—

CAPACITOR MARKINGS

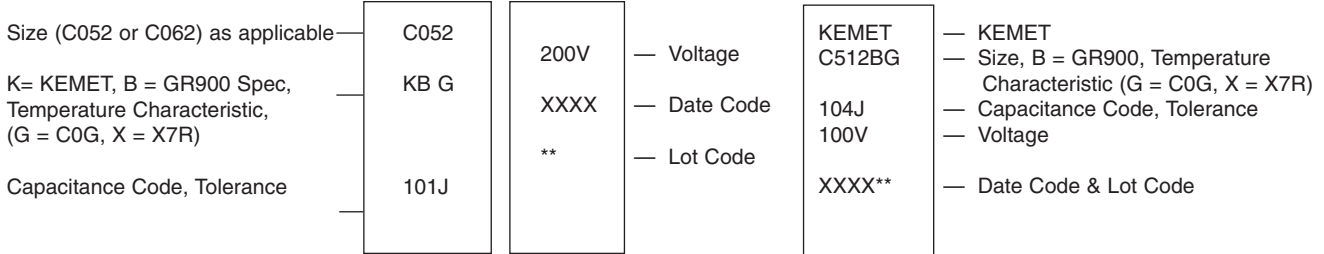

RATINGS & PART NUMBER REFERENCE

CAPACITANCE pF	KEMET PART NUMBER
200 VOLT - BP - STYLE C052	
1.0	C052B109 Δ 2G5CA
1.1	C052B119 Δ 2G5CA
1.2	C052B129 Δ 2G5CA
1.5	C052B159 Δ 2G5CA
1.8	C052B189 Δ 2G5CA
2.0	C052B209 Δ 2G5CA
2.2	C052B229 Δ 2G5CA
2.4	C052B249 Δ 2G5CA
2.7	C052B279 Δ 2G5CA
3.0	C052B309 Δ 2G5CA
3.3	C052B339 Δ 2G5CA
3.6	C052B369 Δ 2G5CA
3.9	C052B399 Δ 2G5CA
4.3	C052B439 Δ 2G5CA
4.7	C052B479 Δ 2G5CA
5.1	C052B519 Δ 2G5CA
5.6	C052B569 Δ 2G5CA
6.2	C052B629 Δ 2G5CA
6.8	C052B689 Δ 2G5CA
7.5	C052B759 Δ 2G5CA
8.2	C052B829 Δ 2G5CA
9.1	C052B919 Δ 2G5CA
10.0	C052B100 Δ 2G5CA
11.0	C052B110 Δ 2G5CA
12.0	C052B120 Δ 2G5CA
13.0	C052B130 Δ 2G5CA
15.0	C052B150 Δ 2G5CA
16.0	C052B160 Δ 2G5CA
18.0	C052B180 Δ 2G5CA
20.0	C052B200 Δ 2G5CA
22.0	C052B220 Δ 2G5CA
24.0	C052B240 Δ 2G5CA
27.0	C052B270 Δ 2G5CA
30.0	C052B300 Δ 2G5CA

CAPACITANCE pF	KEMET PART NUMBER
200 VOLT - BP - STYLE C052 (Cont'd)	
33.0	C052B330 Δ 2G5CA
36.0	C052B360 Δ 2G5CA
39.0	C052B390 Δ 2G5CA
43.0	C052B430 Δ 2G5CA
47.0	C052B470 Δ 2G5CA
51.0	C052B510 Δ 2G5CA
56.0	C052B560 Δ 2G5CA
62.0	C052B620 Δ 2G5CA
68.0	C052B680 Δ 2G5CA
75.0	C052B750 Δ 2G5CA
82.0	C052B820 Δ 2G5CA
91.0	C052B910 Δ 2G5CA
100	C052B101 Δ 2G5CA
110	C052B111 Δ 2G5CA
120	C052B121 Δ 2G5CA
130	C052B131 Δ 2G5CA
150	C052B151 Δ 2G5CA
160	C052B161 Δ 2G5CA
180	C052B181 Δ 2G5CA
200	C052B201 Δ 2G5CA
220	C052B221 Δ 2G5CA
240	C052B241 Δ 2G5CA
270	C052B271 Δ 2G5CA
300	C052B301 Δ 2G5CA
330	C052B331 Δ 2G5CA
360	C052B361 Δ 2G5CA
390	C052B391 Δ 2G5CA
430	C052B431 Δ 2G5CA
470	C052B471 Δ 2G5CA
510	C052B511 Δ 2G5CA
560	C052B561 Δ 2G5CA
620	C052B621 Δ 2G5CA
680	C052B681 Δ 2G5CA
750	C052B751 Δ 2G5CA

(1) Complete KEMET part number by inserting capacitance tolerance, as applicable as shown in ordering information on page 13

BP CAPACITANCE TOLERANCE: $\pm 1\%$, $\pm 2\%$, $\pm 5\%$, $\pm 10\%$, $\pm 20\%$ ($\pm 0.5\text{pF}$ & $\pm 0.25\text{pF}$ tolerances available 1.0 thru 9.1pF only) TEMPERATURE CHARACTERISTIC "G"

BX CAPACITANCE TOLERANCE: $\pm 5\%$, $\pm 10\%$, $\pm 20\%$ TEMPERATURE CHARACTERISTIC "X"

(2) Capacitance values shown above are standard. Other capacitance values are available upon request.

RATINGS & PART NUMBER REFERENCE

CAPACITANCE pF	KEMET PART NUMBER
200 VOLT - BP - STYLE C052 (Cont'd)	
820	C052B821 μ 2G5CA
910	C052B911 μ 2G5CA
1000	C052B102 μ 2G5CA
1100	C052B112 μ 2G5CA
1200	C052B122 μ 2G5CA
1300	C052B132 μ 2G5CA
1500	C052B152 μ 2G5CA
100 VOLT - BP - STYLE C052	
1600	C052B162 μ 1G5CA
1800	C052B182 μ 1G5CA
2000	C052B202 μ 1G5CA
2200	C052B222 μ 1G5CA
2400	C052B242 μ 1G5CA
2700	C052B272 μ 1G5CA
3000	C052B302 μ 1G5CA
3300	C052B332 μ 1G5CA
3600	C052B362 μ 1G5CA
3900	C052B392 μ 1G5CA
4300	C052B432 μ 1G5CA
4700	C052B472 μ 1G5CA
5100	C052B512 μ 1G5CA
5600	C052B562 μ 1G5CA
50 VOLT - BP - STYLE C052	
6200	C052B622 μ 5G5CA
6800	C052B682 μ 5G5CA
200 VOLT - BX - STYLE C052	
470	C052B471 μ 2X5CA
560	C052B561 μ 2X5CA
680	C052B681 μ 2X5CA
820	C052B821 μ 2X5CA
1000	C052B102 μ 2X5CA
1200	C052B122 μ 2X5CA
1500	C052B152 μ 2X5CA
1800	C052B182 μ 2X5CA
2200	C052B222 μ 2X5CA
2700	C052B272 μ 2X5CA
3300	C052B332 μ 2X5CA
3900	C052B392 μ 2X5CA
4700	C052B472 μ 2X5CA
5600	C052B562 μ 2X5CA
6800	C052B682 μ 2X5CA
8200	C052B822 μ 2X5CA
10,000	C052B103 μ 2X5CA
12,000	C052B123 μ 2X5CA
15,000	C052B153 μ 2X5CA
100 VOLT - BX - STYLE C052	
18,000	C052B183 μ 1X5CA
22,000	C052B223 μ 1X5CA
27,000	C052B273 μ 1X5CA
33,000	C052B333 μ 1X5CA
39,000	C052B393 μ 1X5CA
47,000	C052B473 μ 1X5CA
50 VOLT - BX - STYLE C052	
56,000	C052B563 μ 5X5CA
68,000	C052B683 μ 5X5CA
82,000	C052B823 μ 5X5CA
100,000	C052B104 μ 5X5CA
120,000	C052B124 μ 5X5CA
150,000	C052B154 μ 5X5CA
200 VOLT - BP - STYLE C062	
270	C062B271 μ 2G5CA
330	C062B331 μ 2G5CA
360	C062B361 μ 2G5CA
390	C062B391 μ 2G5CA

CAPACITANCE pF	KEMET PART NUMBER
200 VOLT - BP - STYLE C062 (Cont'd)	
430	C062B431 μ 2G5CA
470	C062B471 μ 2G5CA
510	C062B511 μ 2G5CA
560	C062B561 μ 2G5CA
620	C062B621 μ 2G5CA
680	C062B681 μ 2G5CA
750	C062B751 μ 2G5CA
820	C062B821 μ 2G5CA
910	C062B911 μ 2G5CA
1000	C062B102 μ 2G5CA
1100	C062B112 μ 2G5CA
1200	C062B122 μ 2G5CA
1300	C062B132 μ 2G5CA
1500	C062B152 μ 2G5CA
1600	C062B162 μ 2G5CA
1800	C062B182 μ 2G5CA
2000	C062B202 μ 2G5CA
2200	C062B222 μ 2G5CA
2400	C062B242 μ 2G5CA
2700	C062B272 μ 2G5CA
3000	C062B302 μ 2G5CA
3300	C062B332 μ 2G5CA
3600	C062B362 μ 2G5CA
3900	C062B392 μ 2G5CA
4700	C062B472 μ 2G5CA
5100	C062B512 μ 2G5CA
5600	C062B562 μ 2G5CA
6200	C062B622 μ 2G5CA
6800	C062B682 μ 2G5CA
100 VOLT - BP - STYLE C062	
7500	C062B752 μ 1G5CA
8200	C062B822 μ 1G5CA
9100	C062B912 μ 1G5CA
10,000	C062B103 μ 1G5CA
11,000	C062B113 μ 1G5CA
12,000	C062B123 μ 1G5CA
13,000	C062B133 μ 1G5CA
15,000	C062B153 μ 1G5CA
16,000	C062B163 μ 1G5CA
18,000	C062B183 μ 1G5CA
20,000	C062B203 μ 1G5CA
22,000	C062B223 μ 1G5CA
24,000	C062B243 μ 1G5CA
200 VOLT - BX - STYLE C062	
3300	C062B332 μ 2X5CA
3900	C062B392 μ 2X5CA
4700	C062B472 μ 2X5CA
5600	C062B562 μ 2X5CA
6800	C062B682 μ 2X5CA
8200	C062B822 μ 2X5CA
10,000	C062B103 μ 2X5CA
12,000	C062B123 μ 2X5CA
15,000	C062B153 μ 2X5CA
18,000	C062B183 μ 2X5CA
22,000	C062B223 μ 2X5CA
27,000	C062B273 μ 2X5CA
33,000	C062B333 μ 2X5CA
39,000	C062B393 μ 2X5CA
47,000	C062B473 μ 2X5CA
56,000	C062B563 μ 2X5CA
68,000	C062B683 μ 2X5CA

(1) Complete KEMET part number by inserting capacitance tolerance, as applicable as shown in ordering information on page 13. **BP CAPACITANCE TOLERANCE:** $\pm 1\%$, $\pm 2\%$, $\pm 5\%$, $\pm 10\%$, $\pm 20\%$ ($\pm 0.5\text{pF}$ & $\pm 0.25\text{pF}$ tolerances available 1.0 thru 9.1pF only) TEMPERATURE CHARACTERISTIC "G" **BX CAPACITANCE TOLERANCE:** $\pm 5\%$, $\pm 10\%$, $\pm 20\%$ TEMPERATURE CHARACTERISTIC "X" (2) Capacitance values shown above are standard. Other capacitance values are available upon request.

RATINGS & PART NUMBER REFERENCE

CAPACITANCE pF	KEMET PART NUMBER
100 VOLT - BX - STYLE C062	
82,000	C062B823 <u>1</u> 1X5CA
100,000	C062B104 <u>1</u> 1X5CA
120,000	C062B124 <u>1</u> 1X5CA
150,000	C062B154 <u>1</u> 1X5CA
180,000	C062B184 <u>1</u> 1X5CA
220,000	C062B224 <u>1</u> 1X5CA
50 VOLT - BX - STYLE C062	
270,000	C062B274 <u>1</u> 5X5CA
330,000	C062B334 <u>1</u> 5X5CA
390,000	C062B394 <u>1</u> 5X5CA
470,000	C062B474 <u>1</u> 5X5CA
560,000	C062B564 <u>1</u> 5X5CA
680,000	C062B684 <u>1</u> 5X5CA
820,000	C062B824 <u>1</u> 5X5CA
1,000,000	C062B105 <u>1</u> 5X5CA
200 VOLT - BP- STYLE C512	
2000	C512B202 <u>1</u> 2G5CA
2200	C512B222 <u>1</u> 2G5CA
2400	C512B242 <u>1</u> 2G5CA
2700	C512B272 <u>1</u> 2G5CA
3000	C512B302 <u>1</u> 2G5CA
3300	C512B332 <u>1</u> 2G5CA
3600	C512B362 <u>1</u> 2G5CA
3900	C512B392 <u>1</u> 2G5CA
4300	C512B432 <u>1</u> 2G5CA
4700	C512B472 <u>1</u> 2G5CA
5600	C512B562 <u>1</u> 2G5CA
6800	C512B682 <u>1</u> 2G5CA
8200	C512B822 <u>1</u> 2G5CA
10,000	C512B103 <u>1</u> 2G5CA
12,000	C512B123 <u>1</u> 2G5CA
15,000	C512B153 <u>1</u> 2G5CA
18,000	C512B183 <u>1</u> 2G5CA
22,000	C512B223 <u>1</u> 2G5CA
27,000	C512B273 <u>1</u> 2G5CA
33,000	C512B333 <u>1</u> 2G5CA
100 VOLT - BP- STYLE C512	
39,000	C512B393 <u>1</u> 1G5CA
47,000	C512B473 <u>1</u> 1G5CA
56,000	C512B563 <u>1</u> 1G5CA
68,000	C512B683 <u>1</u> 1G5CA
82,000	C512B823 <u>1</u> 1G5CA
100,000	C512B104 <u>1</u> 1G5CA

CAPACITANCE pF	KEMET PART NUMBER
50 VOLT - BP- STYLE C512	
120,000	C512B124 <u>1</u> 5G5CA
150,000	C512B154 <u>1</u> 5G5CA
200 VOLT - BX - STYLE C512	
39,000	C512B393 <u>1</u> 2X5CA
47,000	C512B473 <u>1</u> 2X5CA
56,000	C512B563 <u>1</u> 2X5CA
68,000	C512B683 <u>1</u> 2X5CA
82,000	C512B823 <u>1</u> 2X5CA
100,000	C512B104 <u>1</u> 2X5CA
120,000	C512B124 <u>1</u> 2X5CA
150,000	C512B154 <u>1</u> 2X5CA
180,000	C512B184 <u>1</u> 2X5CA
220,000	C512B224 <u>1</u> 2X5CA
270,000	C512B274 <u>1</u> 2X5CA
330,000	C512B334 <u>1</u> 2X5CA
390,000	C512B394 <u>1</u> 2X5CA
100 VOLT - BX - STYLE C512	
470,000	C512B474 <u>1</u> 1X5CA
560,000	C512B564 <u>1</u> 1X5CA
680,000	C512B684 <u>1</u> 1X5CA
820,000	C512B824 <u>1</u> 1X5CA
1,000,000	C512B105 <u>1</u> 1X5CA
50 VOLT - BX - STYLE C512	
1,200,000	C512B125 <u>1</u> 5X5CA
1,500,000	C512B155 <u>1</u> 5X5CA
2,000,000	C512B205 <u>1</u> 5X5CA
2,200,000	C512B225 <u>1</u> 5X5CA
3,300,000	C512B335 <u>1</u> 5X5CA

(1) Complete KEMET part number by inserting capacitance tolerance, as applicable as shown in ordering information on page 13.

BP CAPACITANCE TOLERANCE: ±1%, ±2%, ±5%, ±10%, ±20% (±0.5pF & ±0.25pF tolerances available 1.0 thru 9.1pF only) TEMPERATURE CHARACTERISTIC "G"

BX CAPACITANCE TOLERANCE: ±5%, ±10%, ±20% TEMPERATURE CHARACTERISTIC "X"

(2) Capacitance values shown above are standard. Other capacitance values are available upon request.

CAPACITOR OUTLINE DRAWINGS

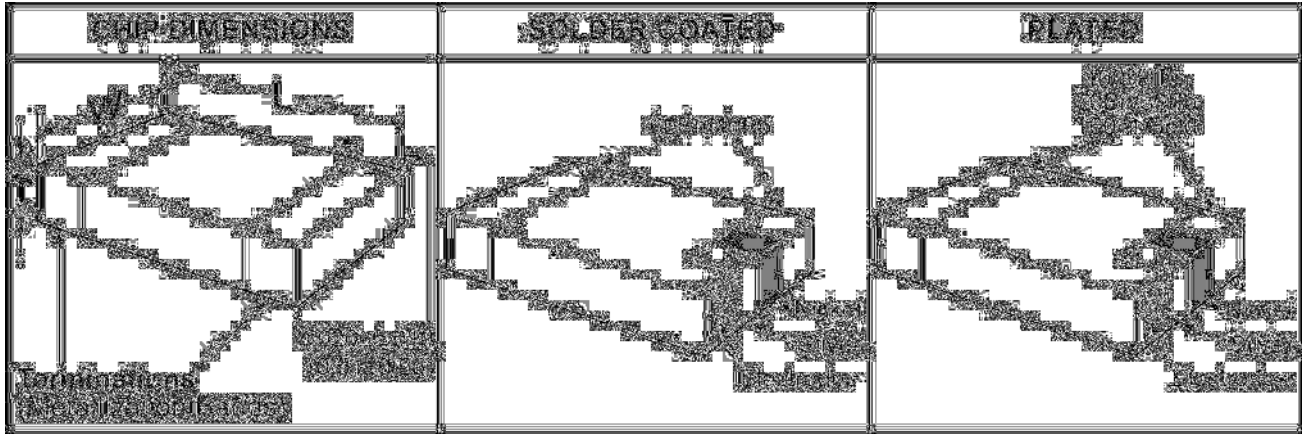

*Add .38mm (.015") to the positive width and thickness tolerance dimensions and .64mm (.025") to the positive length tolerance dimension for the Sn60 solder coated product.

DIMENSIONS — MILLIMETERS (INCHES)

Size Code	L Length	W Width	T Thickness Max.
0504	1.269 (.050) ± 0.254 (.010)	1.015 (.040) ± 0.254 (.010)	1.142 (.045)
0805	2.03 (.080) ± 0.38 (.015)	1.27 (.050) ± 0.38 (.015)	1.4 (.055)
1005	2.56 (.100) ± 0.38 (.015)	1.27 (.050) ± 0.38 (.015)	1.5 (.059)
1206	3.07 (.120) ± 0.38 (.015)	1.52 (.060) ± 0.38 (.015)	1.6 (.065)
1210	3.07 (.120) ± 0.38 (.015)	2.56 (.100) ± 0.38 (.015)	1.6 (.065)
1805	4.57 (.180) ± 0.38 (.015)	1.27 (.050) ± 0.38 (.015)	1.4 (.055)
1808	4.57 (.180) ± 0.38 (.015)	2.03 (.080) ± 0.38 (.015)	1.6 (.065)
1812	4.57 (.180) ± 0.38 (.015)	3.18 (.125) ± 0.38 (.015)	2.03 (.080)
1825	4.57 (.180) ± 0.38 (.015)	6.35 (.250) ± 0.38 (.015)	2.03 (.080)
2225	5.59 (.220) ± 0.38 (.015)	6.35 (.250) ± 0.38 (.015)	2.03 (.080)

ORDERING INFORMATION

C 0805 A 103 K 5 X A C

CERAMIC SIZE CODE
See table above

SPECIFICATION
A — KEMET GR900 (CHIPS); Q — MIL-PRF-123 In Process & Group A

CAPACITANCE CODE
Expressed in Picofarads (pF)
First two digit-significant figures.
Third digit-number of zeros. (Use 9 for 1.0 thru 9.9 pF.
Example: 2.2 pF — 229).

CAPACITANCE TOLERANCE
M — ±20% G — ±2% (G(BP) Temperature Characteristic Only)
K — ±10% F — ±1% (G(BP) Temperature Characteristic Only)
J — ±5% *D — ±0.5 pF (G(BP) Temperature Characteristic Only)
 *C — ±0.25 pF (G(BP) Temperature Characteristic Only)

*These tolerances available only for 1.0 through 10 pF capacitors.

VOLTAGE
1—100
2—200
5—50

END METALLIZATION

- C—Tin-Plated
- H—Solder-Coated
- L—70/30 Tin/Lead Plated
- G—Gold Plated

FAILURE RATE LEVEL (%/1,000 HOURS)

A—Standard—Not applicable

TEMPERATURE CHARACTERISTIC

Designated by Capacitance Change over Temperature Range
G—BP (±30 PPM/°C)
X—BX (±15%, +15%, -25% with bias.)

MARKING

Capacitors shall be legibly laser marked in contrasting color with the KEMET trademark and 2-digit capacitance symbol.

RATINGS AND PART NUMBER REFERENCE

STYLE C0504

CAPACITANCE pF	KEMET PART NUMBER
200 VOLT - BP	
1.0	C0504A109(1)2GA(2)
1.1	C0504A119(1)2GA(2)
1.2	C0504A129(1)2GA(2)
1.5	C0504A159(1)2GA(2)
1.6	C0504A169(1)2GA(2)
1.8	C0504A189(1)2GA(2)
2.0	C0504A209(1)2GA(2)
2.2	C0504A229(1)2GA(2)
2.4	C0504A249(1)2GA(2)
2.7	C0504A279(1)2GA(2)
3.0	C0504A309(1)2GA(2)
3.3	C0504A339(1)2GA(2)
3.6	C0504A369(1)2GA(2)
3.9	C0504A399(1)2GA(2)
4.3	C0504A439(1)2GA(2)
4.7	C0504A479(1)2GA(2)
5.1	C0504A519(1)2GA(2)
5.6	C0504A569(1)2GA(2)
6.2	C0504A629(1)2GA(2)
6.8	C0504A689(1)2GA(2)
7.5	C0504A759(1)2GA(2)
8.2	C0504A829(1)2GA(2)
9.1	C0504A919(1)2GA(2)
10.0	C0504A100(1)2GA(2)
11.0	C0504A110(1)2GA(2)
12.0	C0504A120(1)2GA(2)
13.0	C0504A130(1)2GA(2)
15.0	C0504A150(1)2GA(2)
16.0	C0504A160(1)2GA(2)
18.0	C0504A180(1)2GA(2)
20.0	C0504A200(1)2GA(2)
22.0	C0504A220(1)2GA(2)
24.0	C0504A240(1)2GA(2)
27.0	C0504A270(1)2GA(2)
30.0	C0504A300(1)2GA(2)
33.0	C0504A330(1)2GA(2)
36.0	C0504A360(1)2GA(2)
39.0	C0504A390(1)2GA(2)
43.0	C0504A430(1)2GA(2)
47.0	C0504A470(1)2GA(2)
51.0	C0504A510(1)2GA(2)
56.0	C0504A560(1)2GA(2)
62.0	C0504A620(1)2GA(2)
75.0	C0504A750(1)2GA(2)
82.0	C0504A820(1)2GA(2)
100 VOLT - BP	
91.0	C0504A910(1)1GA(2)
100	C0504A101(1)1GA(2)
110	C0504A111(1)1GA(2)
120	C0504A121(1)1GA(2)
130	C0504A131(1)1GA(2)
50 VOLT - BP	
150	C0504A151(1)5GA(2)
160	C0504A161(1)5GA(2)
180	C0504A181(1)5GA(2)

CAPACITANCE pF	KEMET PART NUMBER
200 VOLT - BX	
220	C0504A221(1)2XA(2)
270	C0504A271(1)2XA(2)
330	C0504A331(1)2XA(2)
100 VOLT - BX	
360	C0504A361(1)1XA(2)
390	C0504A391(1)1XA(2)
470	C0504A471(1)1XA(2)
560	C0504A561(1)1XA(2)
680	C0504A681(1)1XA(2)
820	C0504A821(1)1XA(2)
1000	C0504A102(1)1XA(2)
1200	C0504A122(1)1XA(2)

CAPACITANCE pF	KEMET PART NUMBER
50 VOLT - BX	
1500	C0504A152(1)5XA(2)
1800	C0504A182(1)5XA(2)
2200	C0504A222(1)5XA(2)
2700	C0504A272(1)5XA(2)
3300	C0504A332(1)5XA(2)
3900	C0504A392(1)5XA(2)
4700	C0504A472(1)5XA(2)
5600	C0504A562(1)5XA(2)
6800	C0504A682(1)5XA(2)

STYLE C0805

CAPACITANCE pF	KEMET PART NUMBER
200 VOLT - BP	
1.0	C0805A109(1)2GA(2)
1.1	C0805A119(1)2GA(2)
1.2	C0805A129(1)2GA(2)
1.5	C0805A159(1)2GA(2)
1.6	C0805A169(1)2GA(2)
1.8	C0805A189(1)2GA(2)
2.0	C0805A209(1)2GA(2)
2.2	C0805A229(1)2GA(2)
2.4	C0805A249(1)2GA(2)
2.7	C0805A279(1)2GA(2)
3.0	C0805A309(1)2GA(2)
3.3	C0805A339(1)2GA(2)
3.6	C0805A369(1)2GA(2)
3.9	C0805A399(1)2GA(2)
4.3	C0805A439(1)2GA(2)
4.7	C0805A479(1)2GA(2)
5.1	C0805A519(1)2GA(2)
5.6	C0805A569(1)2GA(2)
6.2	C0805A629(1)2GA(2)
6.8	C0805A689(1)2GA(2)
7.5	C0805A759(1)2GA(2)
8.2	C0805A829(1)2GA(2)
9.1	C0805A919(1)2GA(2)
10.0	C0805A100(1)2GA(2)
11.0	C0805A110(1)2GA(2)
12.0	C0805A120(1)2GA(2)
13.0	C0805A130(1)2GA(2)
15.0	C0805A150(1)2GA(2)
16.0	C0805A160(1)2GA(2)
18.0	C0805A180(1)2GA(2)
20.0	C0805A200(1)2GA(2)
22.0	C0805A220(1)2GA(2)
24.0	C0805A240(1)2GA(2)
27.0	C0805A270(1)2GA(2)
30.0	C0805A300(1)2GA(2)
33.0	C0805A330(1)2GA(2)
36.0	C0805A360(1)2GA(2)
39.0	C0805A390(1)2GA(2)
43.0	C0805A430(1)2GA(2)
47.0	C0805A470(1)2GA(2)
51.0	C0805A510(1)2GA(2)
56.0	C0805A560(1)2GA(2)
62.0	C0805A620(1)2GA(2)
75.0	C0805A750(1)2GA(2)
82.0	C0805A820(1)2GA(2)
91.0	C0805A910(1)2GA(2)
100	C0805A101(1)2GA(2)
110	C0805A111(1)2GA(2)
120	C0805A121(1)2GA(2)
130	C0805A131(1)2GA(2)
150	C0805A151(1)2GA(2)
160	C0805A161(1)2GA(2)
180	C0805A181(1)2GA(2)
200	C0805A201(1)2GA(2)
220	C0805A221(1)2GA(2)

CAPACITANCE pF	KEMET PART NUMBER
100 VOLT - BP	
240	C0805A241(1)1GA(2)
270	C0805A271(1)1GA(2)
300	C0805A301(1)1GA(2)
330	C0805A331(1)1GA(2)
360	C0805A361(1)1GA(2)
390	C0805A391(1)1GA(2)
430	C0805A431(1)1GA(2)
470	C0805A471(1)1GA(2)
50 VOLT - BP	
510	C0805A511(1)5GA(2)
560	C0805A561(1)5GA(2)

CAPACITANCE pF	KEMET PART NUMBER
200 VOLT - BX	
180	C0805A181(1)2XA(2)
220	C0805A221(1)2XA(2)
270	C0805A271(1)2XA(2)
330	C0805A331(1)2XA(2)
390	C0805A391(1)2XA(2)
470	C0805A471(1)2XA(2)
560	C0805A561(1)2XA(2)
680	C0805A681(1)2XA(2)
820	C0805A821(1)2XA(2)
100 VOLT - BX	
1000	C0805A102(1)1XA(2)
1200	C0805A122(1)1XA(2)
1500	C0805A152(1)1XA(2)
1800	C0805A182(1)1XA(2)
2200	C0805A222(1)1XA(2)
3300	C0805A332(1)1XA(2)
3900	C0805A392(1)1XA(2)
4700	C0805A472(1)1XA(2)
50 VOLT - BX	
6800	C0805A682(1)5XA(2)
8200	C0805A822(1)5XA(2)
10000	C0805A103(1)5XA(2)

(1) Complete KEMET part number by inserting capacitance tolerance, as applicable as shown in ordering information on page 17.

BP CAPACITANCE TOLERANCE: ±1%, ±2%, ±5%, ±10%, ±20% (±0.5pF & ±0.25pF tolerances available 1.0 thru 10pF only) **TEMPERATURE CHARACTERISTIC "G"**

BX CAPACITANCE TOLERANCE: ±5%, ±10%, ±20% **TEMPERATURE CHARACTERISTIC "X"**

(2) Complete part number by inserting end Metallization, as applicable as shown in ordering information on page 17.

**RATINGS AND PART NUMBER REFERENCE
STYLE C1005**

CAPACITANCE pF	KEMET PART NUMBER
200 VOLT - BP	
1.0	C1005A109(1)2GA(2)
1.1	C1005A119(1)2GA(2)
1.2	C1005A129(1)2GA(2)
1.5	C1005A159(1)2GA(2)
1.6	C1005A169(1)2GA(2)
1.8	C1005A189(1)2GA(2)
2.0	C1005A209(1)2GA(2)
2.2	C1005A229(1)2GA(2)
2.4	C1005A249(1)2GA(2)
2.7	C1005A279(1)2GA(2)
3.0	C1005A309(1)2GA(2)
3.3	C1005A339(1)2GA(2)
3.6	C1005A369(1)2GA(2)
3.9	C1005A399(1)2GA(2)
4.3	C1005A439(1)2GA(2)
4.7	C1005A479(1)2GA(2)
5.1	C1005A519(1)2GA(2)
5.6	C1005A569(1)2GA(2)
6.8	C1005A689(1)2GA(2)
7.5	C1005A759(1)2GA(2)
8.2	C1005A829(1)2GA(2)
9.1	C1005A919(1)2GA(2)
10.0	C1005A100(1)2GA(2)
11.0	C1005A110(1)2GA(2)
12.0	C1005A120(1)2GA(2)
13.0	C1005A130(1)2GA(2)
15.0	C1005A150(1)2GA(2)
16.0	C1005A160(1)2GA(2)
18.0	C1005A180(1)2GA(2)
20.0	C1005A200(1)2GA(2)
22.0	C1005A220(1)2GA(2)
24.0	C1005A240(1)2GA(2)
27.0	C1005A270(1)2GA(2)
30.0	C1005A300(1)2GA(2)
33.0	C1005A330(1)2GA(2)
36.0	C1005A360(1)2GA(2)
39.0	C1005A390(1)2GA(2)
43.0	C1005A430(1)2GA(2)
47.0	C1005A470(1)2GA(2)
51.0	C1005A510(1)2GA(2)
56.0	C1005A560(1)2GA(2)
62.0	C1005A620(1)2GA(2)
75.0	C1005A750(1)2GA(2)
82.0	C1005A820(1)2GA(2)
91.0	C1005A910(1)2GA(2)
100	C1005A101(1)2GA(2)
110	C1005A111(1)2GA(2)
120	C1005A121(1)2GA(2)
130	C1005A131(1)2GA(2)
150	C1005A151(1)2GA(2)
160	C1005A161(1)2GA(2)

CAPACITANCE pF	KEMET PART NUMBER
200 VOLT - BP	
180	C1005A181(1)2GA(2)
200	C1005A201(1)2GA(2)
220	C1005A221(1)2GA(2)
240	C1005A241(1)2GA(2)
270	C1005A271(1)2GA(2)
300	C1005A301(1)2GA(2)
330	C1005A331(1)2GA(2)
360	C1005A361(1)2GA(2)
390	C1005A391(1)2GA(2)
430	C1005A431(1)2GA(2)
470	C1005A471(1)2GA(2)
100 VOLT - BP	
510	C1005A511(1)1GA(2)
560	C1005A561(1)1GA(2)
620	C1005A621(1)1GA(2)
680	C1005A681(1)1GA(2)
750	C1005A751(1)1GA(2)
820	C1005A821(1)1GA(2)
50 VOLT - BP	
910	C1005A911(1)5GA(2)
1000	C1005A102(1)5GA(2)
1100	C1005A112(1)5GA(2)
1200	C1005A122(1)5GA(2)
200 VOLT - BX	
330	C1005A331(1)2XA(2)
390	C1005A391(1)2XA(2)
470	C1005A471(1)2XA(2)
560	C1005A561(1)2XA(2)
680	C1005A681(1)2XA(2)
820	C1005A821(1)2XA(2)
1000	C1005A102(1)2XA(2)
1200	C1005A122(1)2XA(2)
1500	C1005A152(1)2XA(2)
1800	C1005A182(1)2XA(2)
100 VOLT - BX	
2200	C1005A222(1)1XA(2)
2700	C1005A272(1)1XA(2)
3300	C1005A332(1)1XA(2)
3900	C1005A392(1)1XA(2)
4700	C1005A472(1)1XA(2)
5600	C1005A562(1)1XA(2)
6800	C1005A682(1)1XA(2)
8200	C1005A822(1)1XA(2)
10,000	C1005A103(1)1XA(2)
50 VOLT - BX	
12,000	C1005A123(1)5XA(2)
15,000	C1005A153(1)5XA(2)
18,000	C1005A183(1)5XA(2)
22,000	C1005A223(1)5XA(2)

**RATINGS AND PART NUMBER REFERENCE
STYLE C1206**

CAPACITANCE pF	KEMET PART NUMBER
200 VOLT - BP	
10.0	C1206A100(1)2GA(2)
11.0	C1206A110(1)2GA(2)
12.0	C1206A120(1)2GA(2)
13.0	C1206A130(1)2GA(2)
15.0	C1206A150(1)2GA(2)
16.0	C1206A160(1)2GA(2)
18.0	C1206A180(1)2GA(2)
20.0	C1206A200(1)2GA(2)
22.0	C1206A220(1)2GA(2)
24.0	C1206A240(1)2GA(2)

CAPACITANCE pF	KEMET PART NUMBER
200 VOLT - BP	
27.0	C1206A270(1)2GA(2)
30.0	C1206A300(1)2GA(2)
33.0	C1206A330(1)2GA(2)
36.0	C1206A360(1)2GA(2)
39.0	C1206A390(1)2GA(2)
43.0	C1206A430(1)2GA(2)
47.0	C1206A470(1)2GA(2)
51.0	C1206A510(1)2GA(2)
56.0	C1206A560(1)2GA(2)
62.0	C1206A620(1)2GA(2)

(1) Complete KEMET part number by inserting capacitance tolerance, as applicable as shown in ordering information on page 17.
BP CAPACITANCE TOLERANCE: ±1%, ±2%, ±5%, ±10%, ±20% (±0.5pF & ±0.25pF tolerances available 1.0 thru 10pF only) **TEMPERATURE CHARACTERISTIC "G"**
BX CAPACITANCE TOLERANCE: ±5%, ±10%, ±20% **TEMPERATURE CHARACTERISTIC "X"**
(2) Complete part number by inserting end Metallization, as applicable as shown in ordering information on page 17.

RATINGS AND PART NUMBER REFERENCE
STYLE C1206 (continued)

CAPACITANCE pF	KEMET PART NUMBER
200 VOLT - BP	
68.0	C1206A680(1)2GA(2)
75.0	C1206A750(1)2GA(2)
82.0	C1206A820(1)2GA(2)
91.0	C1206A910(1)2GA(2)
100	C1206A101(1)2GA(2)
110	C1206A111(1)2GA(2)
120	C1206A121(1)2GA(2)
130	C1206A131(1)2GA(2)
150	C1206A151(1)2GA(2)
160	C1206A161(1)2GA(2)
180	C1206A181(1)2GA(2)
200	C1206A201(1)2GA(2)
220	C1206A221(1)2GA(2)
240	C1206A241(1)2GA(2)
270	C1206A271(1)2GA(2)
300	C1206A301(1)2GA(2)
330	C1206A331(1)2GA(2)
360	C1206A361(1)2GA(2)
390	C1206A391(1)2GA(2)
430	C1206A431(1)2GA(2)
470	C1206A471(1)2GA(2)
100 VOLT - BP	
510	C1206A511(1)1GA(2)
560	C1206A561(1)1GA(2)
620	C1206A621(1)1GA(2)
680	C1206A681(1)1GA(2)
750	C1206A751(1)1GA(2)
820	C1206A821(1)1GA(2)
910	C1206A911(1)1GA(2)
1000	C1206A102(1)1GA(2)
1100	C1206A112(1)1GA(2)
1200	C1206A122(1)1GA(2)
1300	C1206A132(1)1GA(2)
1500	C1206A152(1)1GA(2)
1600	C1206A162(1)1GA(2)

CAPACITANCE pF	KEMET PART NUMBER
50 VOLT - BP	
1800	C1206A182(1)5GA(2)
2000	C1206A202(1)5GA(2)
200 VOLT - BX	
470	C1206A471(1)2XA(2)
560	C1206A561(1)2XA(2)
680	C1206A681(1)2XA(2)
820	C1206A821(1)2XA(2)
1000	C1206A102(1)2XA(2)
1200	C1206A122(1)2XA(2)
1500	C1206A152(1)2XA(2)
1800	C1206A182(1)2XA(2)
2200	C1206A222(1)2XA(2)
2700	C1206A272(1)2XA(2)
3300	C1206A332(1)2XA(2)
3900	C1206A392(1)2XA(2)
4700	C1206A472(1)2XA(2)
100 VOLT - BX	
5600	C1206A562(1)1XA(2)
6800	C1206A682(1)1XA(2)
8200	C1206A822(1)1XA(2)
10,000	C1206A103(1)1XA(2)
12,000	C1206A123(1)1XA(2)
15,000	C1206A153(1)1XA(2)
50 VOLT - BX	
18,000	C1206A183(1)5XA(2)
22,000	C1206A223(1)5XA(2)
27,000	C1206A273(1)5XA(2)
33,000	C1206A333(1)5XA(2)
39,000	C1206A393(1)5XA(2)
47,000	C1206A473(1)5XA(2)

RATINGS AND PART NUMBER REFERENCE
STYLE C1210

CAPACITANCE pF	KEMET PART NUMBER
200 VOLT - BP	
10.0	C1210A100(1)2GA(2)
11.0	C1210A110(1)2GA(2)
12.0	C1210A120(1)2GA(2)
13.0	C1210A130(1)2GA(2)
15.0	C1210A150(1)2GA(2)
16.0	C1210A160(1)2GA(2)
18.0	C1210A180(1)2GA(2)
20.0	C1210A200(1)2GA(2)
22.0	C1210A220(1)2GA(2)
24.0	C1210A240(1)2GA(2)
27.0	C1210A270(1)2GA(2)
30.0	C1210A300(1)2GA(2)
33.0	C1210A330(1)2GA(2)
36.0	C1210A360(1)2GA(2)
39.0	C1210A390(1)2GA(2)
43.0	C1210A430(1)2GA(2)
47.0	C1210A470(1)2GA(2)
51.0	C1210A510(1)2GA(2)
56.0	C1210A560(1)2GA(2)
62.0	C1210A620(1)2GA(2)
68.0	C1210A680(1)2GA(2)
75.0	C1210A750(1)2GA(2)
82.0	C1210A820(1)2GA(2)
91.0	C1210A910(1)2GA(2)
100	C1210A101(1)2GA(2)
110	C1210A111(1)2GA(2)
120	C1210A121(1)2GA(2)

CAPACITANCE pF	KEMET PART NUMBER
200 VOLT - BP	
130	C1210A131(1)2GA(2)
150	C1210A151(1)2GA(2)
160	C1210A161(1)2GA(2)
180	C1210A181(1)2GA(2)
200	C1210A201(1)2GA(2)
220	C1210A221(1)2GA(2)
240	C1210A241(1)2GA(2)
270	C1210A271(1)2GA(2)
300	C1210A301(1)2GA(2)
330	C1210A331(1)2GA(2)
360	C1210A361(1)2GA(2)
390	C1210A391(1)2GA(2)
430	C1210A431(1)2GA(2)
470	C1210A471(1)2GA(2)
510	C1210A511(1)2GA(2)
560	C1210A561(1)2GA(2)
620	C1210A621(1)2GA(2)
680	C1210A681(1)2GA(2)
750	C1210A751(1)2GA(2)
820	C1210A821(1)2GA(2)
910	C1210A911(1)2GA(2)
1000	C1210A102(1)2GA(2)

(1) Complete KEMET part number by inserting capacitance tolerance, as applicable as shown in ordering information on page 17.

BP CAPACITANCE TOLERANCE: ±1%, ±2%, ±5%, ±10%, ±20% (±0.5pF & ±0.25pF tolerances available 1.0 thru 10pF only) **TEMPERATURE CHARACTERISTIC "G"**

BX CAPACITANCE TOLERANCE: ±5%, ±10%, ±20% **TEMPERATURE CHARACTERISTIC "X"**

(2) Complete part number by inserting end Metallization, as applicable as shown in ordering information on page 17.

**RATINGS AND PART NUMBER REFERENCE
STYLE C1210 (continued)**

CAPACITANCE pF	KEMET PART NUMBER
100 VOLT - BP	
1100	C1210A112(1)1GA(2)
1200	C1210A122(1)1GA(2)
1300	C1210A132(1)1GA(2)
1500	C1210A152(1)1GA(2)
1600	C1210A162(1)1GA(2)
1800	C1210A182(1)1GA(2)
2000	C1210A202(1)1GA(2)
2200	C1210A222(1)1GA(2)
2400	C1210A242(1)1GA(2)
2700	C1210A272(1)1GA(2)
3000	C1210A302(1)1GA(2)
3300	C1210A332(1)1GA(2)
50 VOLT - BP	
3600	C1210A362(1)5GA(2)
3900	C1210A392(1)5GA(2)
200 VOLT - BX	
470	C1210A471(1)2XA(2)
560	C1210A561(1)2XA(2)
680	C1210A681(1)2XA(2)
820	C1210A821(1)2XA(2)
1000	C1210A102(1)2XA(2)
1200	C1210A122(1)2XA(2)
1500	C1210A152(1)2XA(2)
1800	C1210A182(1)2XA(2)

CAPACITANCE pF	KEMET PART NUMBER
200 VOLT - BX	
2200	C1210A222(1)2XA(2)
2700	C1210A272(1)2XA(2)
3300	C1210A332(1)2XA(2)
3900	C1210A392(1)2XA(2)
4700	C1210A472(1)2XA(2)
5600	C1210A562(1)2XA(2)
6800	C1210A682(1)2XA(2)
8200	C1210A822(1)2XA(2)
10,000	C1210A103(1)2XA(2)
100 VOLT - BX	
12,000	C1210A123(1)1XA(2)
15,000	C1210A153(1)1XA(2)
18,000	C1210A183(1)1XA(2)
22,000	C1210A223(1)1XA(2)
27,000	C1210A273(1)1XA(2)
33,000	C1210A333(1)1XA(2)
50 VOLT - BX	
39,000	C1210A393(1)5XA(2)
47,000	C1210A473(1)5XA(2)
56,000	C1210A563(1)5XA(2)
68,000	C1210A683(1)5XA(2)
82,000	C1210A823(1)5XA(2)
100,000	C1210A104(1)5XA(2)

**RATINGS AND PART NUMBER REFERENCE
STYLE C1805**

CAPACITANCE pF	KEMET PART NUMBER
200 VOLT - BP	
220	C1805A221(1)2GA(2)
240	C1805A241(1)2GA(2)
270	C1805A271(1)2GA(2)
300	C1805A301(1)2GA(2)
330	C1805A331(1)2GA(2)
360	C1805A361(1)2GA(2)
390	C1805A391(1)2GA(2)
430	C1805A431(1)2GA(2)
470	C1805A471(1)2GA(2)
100 VOLT - BP	
510	C1805A511(1)1GA(2)
560	C1805A561(1)1GA(2)
620	C1805A621(1)1GA(2)
680	C1805A681(1)1GA(2)
750	C1805A751(1)1GA(2)
820	C1805A821(1)1GA(2)
910	C1805A911(1)1GA(2)
1000	C1805A102(1)1GA(2)
1100	C1805A112(1)1GA(2)
1200	C1805A122(1)1GA(2)
1300	C1805A132(1)1GA(2)
1500	C1805A152(1)1GA(2)
50 VOLT - BP	
1600	C1805A162(1)5GA(2)
1800	C1805A182(1)5GA(2)
2000	C1805A202(1)5GA(2)
2200	C1805A222(1)5GA(2)

CAPACITANCE pF	KEMET PART NUMBER
200 VOLT - BX	
1200	C1805A122(1)2XA(2)
1500	C1805A152(1)2XA(2)
1800	C1805A182(1)2XA(2)
2200	C1805A222(1)2XA(2)
2700	C1805A272(1)2XA(2)
3300	C1805A332(1)2XA(2)
3900	C1805A392(1)2XA(2)
100 VOLT - BX	
4700	C1805A472(1)1XA(2)
5600	C1805A562(1)1XA(2)
6800	C1805A682(1)1XA(2)
8200	C1805A822(1)1XA(2)
10,000	C1805A103(1)1XA(2)
12,000	C1805A123(1)1XA(2)
15,000	C1805A153(1)1XA(2)
18,000	C1805A183(1)1XA(2)
50 VOLT - BX	
18,000	C1805A183(1)5XA(2)
22,000	C1805A223(1)5XA(2)
27,000	C1805A273(1)5XA(2)
33,000	C1805A333(1)5XA(2)
39,000	C1805A393(1)5XA(2)
47,000	C1805A473(1)5XA(2)

(1) Complete KEMET part number by inserting capacitance tolerance, as applicable as shown in ordering information on page 17.

BP CAPACITANCE TOLERANCE: ±1%, ±2%, ±5%, ±10%, ±20% (±0.5pF & ±0.25pF tolerances available 1.0 thru 10pF only) TEMPERATURE CHARACTERISTIC "G"

BX CAPACITANCE TOLERANCE: ±5%, ±10%, ±20% TEMPERATURE CHARACTERISTIC "X"

(2) Complete part number by inserting end Metallization, as applicable as shown in ordering information on page 17.

RATINGS AND PART NUMBER REFERENCE
STYLE C1808

CAPACITANCE pF	KEMET PART NUMBER
200 VOLT - BP	
330	C1808A331(1)2GA(2)
360	C1808A361(1)2GA(2)
390	C1808A391(1)2GA(2)
430	C1808A431(1)2GA(2)
470	C1808A471(1)2GA(2)
510	C1808A511(1)2GA(2)
560	C1808A561(1)2GA(2)
620	C1808A621(1)2GA(2)
680	C1808A681(1)2GA(2)
750	C1808A751(1)2GA(2)
820	C1808A821(1)2GA(2)
910	C1808A911(1)2GA(2)
1000	C1808A102(1)2GA(2)
1100	C1808A112(1)2GA(2)
1200	C1808A122(1)2GA(2)
1300	C1808A132(1)2GA(2)
1500	C1808A152(1)2GA(2)
100 VOLT - BP	
1600	C1808A162(1)1GA(2)
1800	C1808A182(1)1GA(2)
2000	C1808A202(1)1GA(2)
2200	C1808A222(1)1GA(2)
2400	C1808A242(1)1GA(2)
2700	C1808A272(1)1GA(2)
3000	C1808A302(1)1GA(2)
3300	C1808A332(1)1GA(2)
3600	C1808A362(1)1GA(2)
3900	C1808A392(1)1GA(2)
4300	C1808A432(1)1GA(2)
4700	C1808A472(1)1GA(2)

CAPACITANCE pF	KEMET PART NUMBER
50 VOLT - BP	
5100	C1808A512(1)5GA(2)
5600	C1808A562(1)5GA(2)
200 VOLT - BX	
2200	C1808A222(1)2XA(2)
2700	C1808A272(1)2XA(2)
3300	C1808A332(1)2XA(2)
3900	C1808A392(1)2XA(2)
4700	C1808A472(1)2XA(2)
5600	C1808A562(1)2XA(2)
6800	C1808A682(1)2XA(2)
8200	C1808A822(1)2XA(2)
10,000	C1808A103(1)2XA(2)
100 VOLT - BX	
12,000	C1808A123(1)1XA(2)
15,000	C1808A153(1)1XA(2)
18,000	C1808A183(1)1XA(2)
22,000	C1808A223(1)1XA(2)
27,000	C1808A273(1)1XA(2)
33,000	C1808A333(1)1XA(2)
39,000	C1808A393(1)1XA(2)
47,000	C1808A473(1)1XA(2)
50 VOLT - BX	
39,000	C1808A393(1)5XA(2)
47,000	C1808A473(1)5XA(2)
56,000	C1808A563(1)5XA(2)
68,000	C1808A683(1)5XA(2)
82,000	C1808A823(1)5XA(2)
100,000	C1808A104(1)5XA(2)

RATINGS AND PART NUMBER REFERENCE
STYLE C1812

CAPACITANCE pF	KEMET PART NUMBER
200 VOLT - BP	
330	C1812A331(1)2GA(2)
360	C1812A361(1)2GA(2)
390	C1812A391(1)2GA(2)
430	C1812A431(1)2GA(2)
470	C1812A471(1)2GA(2)
510	C1812A511(1)2GA(2)
560	C1812A561(1)2GA(2)
620	C1812A621(1)2GA(2)
680	C1812A681(1)2GA(2)
750	C1812A751(1)2GA(2)
820	C1812A821(1)2GA(2)
910	C1812A911(1)2GA(2)
1000	C1812A102(1)2GA(2)
1100	C1812A112(1)2GA(2)
1200	C1812A122(1)2GA(2)
1300	C1812A132(1)2GA(2)
1500	C1812A152(1)2GA(2)
1600	C1812A162(1)2GA(2)
1800	C1812A182(1)2GA(2)
2000	C1812A202(1)2GA(2)
2200	C1812A222(1)2GA(2)
2400	C1812A242(1)2GA(2)
2700	C1812A272(1)2GA(2)
100 VOLT - BP	
3000	C1812A302(1)1GA(2)
3300	C1812A332(1)1GA(2)
3600	C1812A362(1)1GA(2)
3900	C1812A392(1)1GA(2)
4300	C1812A432(1)1GA(2)
4700	C1812A472(1)1GA(2)
5100	C1812A512(1)1GA(2)

CAPACITANCE pF	KEMET PART NUMBER
100 VOLT - BP	
5600	C1812A562(1)1GA(2)
6200	C1812A622(1)1GA(2)
6800	C1812A682(1)1GA(2)
50 VOLT - BP	
7500	C1812A752(1)5GA(2)
8200	C1812A822(1)5GA(2)
9100	C1812A912(1)5GA(2)
10,000	C1812A103(1)5GA(2)
200 VOLT - BX	
6800	C1812A682(1)2XA(2)
8200	C1812A822(1)2XA(2)
10,000	C1812A103(1)2XA(2)
12,000	C1812A123(1)2XA(2)
15,000	C1812A153(1)2XA(2)
18,000	C1812A183(1)2XA(2)
100 VOLT - BX	
22,000	C1812A223(1)1XA(2)
27,000	C1812A273(1)1XA(2)
33,000	C1812A333(1)1XA(2)
39,000	C1812A393(1)1XA(2)
47,000	C1812A473(1)1XA(2)
56,000	C1812A563(1)1XA(2)
68,000	C1812A683(1)1XA(2)
82,000	C1812A823(1)1XA(2)
50 VOLT - BX	
82,000	C1812A823(1)5XA(2)
100,000	C1812A104(1)5XA(2)
120,000	C1812A124(1)5XA(2)
150,000	C1812A154(1)5XA(2)
180,000	C1812A184(1)5XA(2)

(1) Complete KEMET part number by inserting capacitance tolerance, as applicable as shown in ordering information on page 17. **BP CAPACITANCE TOLERANCE:** ±1%, ±2%, ±5%, ±10%, ±20% (±0.5pF & ±0.25pF tolerances available 1.0 thru 10pF only) **TEMPERATURE CHARACTERISTIC "G" BX CAPACITANCE TOLERANCE:** ±5%, ±10%, ±20% **TEMPERATURE CHARACTERISTIC "X"** (2) Complete part number by inserting end Metallization, as applicable as shown in ordering information on page 17.

RATINGS AND PART NUMBER REFERENCE STYLE C1825

CAPACITANCE pF	KEMET PART NUMBER
200 VOLT - BP	
2700	C1825A272(1)2GA(2)
3000	C1825A302(1)2GA(2)
3300	C1825A332(1)2GA(2)
3600	C1825A362(1)2GA(2)
3900	C1825A392(1)2GA(2)
4300	C1825A432(1)2GA(2)
4700	C1825A472(1)2GA(2)
5100	C1825A512(1)2GA(2)
5600	C1825A562(1)2GA(2)
100 VOLT - BP	
6200	C1825A622(1)1GA(2)
6800	C1825A682(1)1GA(2)
7500	C1825A752(1)1GA(2)
8200	C1825A822(1)1GA(2)
9100	C1825A912(1)1GA(2)
10,000	C1825A103(1)1GA(2)
11,000	C1825A113(1)1GA(2)
12,000	C1825A123(1)1GA(2)
13,000	C1825A133(1)1GA(2)
15,000	C1825A153(1)1GA(2)
16,000	C1825A163(1)1GA(2)
18,000	C1825A183(1)1GA(2)
50 VOLT - BP	
20,000	C1825A203(1)5GA(2)
22,000	C1825A223(1)5GA(2)

CAPACITANCE pF	KEMET PART NUMBER
200 VOLT - BX	
10,000	C1825A103(1)2XA(2)
12,000	C1825A123(1)2XA(2)
15,000	C1825A153(1)2XA(2)
18,000	C1825A183(1)2XA(2)
22,000	C1825A223(1)2XA(2)
33,000	C1825A333(1)2XA(2)
39,000	C1825A393(1)2XA(2)
47,000	C1825A473(1)2XA(2)
100 VOLT - BX	
56,000	C1825A563(1)1XA(2)
68,000	C1825A683(1)1XA(2)
82,000	C1825A823(1)1XA(2)
100,000	C1825A104(1)1XA(2)
120,000	C1825A124(1)1XA(2)
150,000	C1825A154(1)1XA(2)
180,000	C1825A184(1)1XA(2)
50 VOLT - BX	
180,000	C1825A184(1)5XA(2)
220,000	C1825A224(1)5XA(2)
270,000	C1825A274(1)5XA(2)
330,000	C1825A334(1)5XA(2)
390,000	C1825A394(1)5XA(2)
470,000	C1825A474(1)5XA(2)

RATINGS AND PART NUMBER REFERENCE STYLE C2225

CAPACITANCE pF	KEMET PART NUMBER
200 VOLT - BP	
2700	C2225A272(1)2GA(2)
3000	C2225A302(1)2GA(2)
3300	C2225A332(1)2GA(2)
3600	C2225A362(1)2GA(2)
3900	C2225A392(1)2GA(2)
4300	C2225A432(1)2GA(2)
4700	C2225A472(1)2GA(2)
5100	C2225A512(1)2GA(2)
5600	C2225A562(1)2GA(2)
6200	C2225A622(1)2GA(2)
6800	C2225A682(1)2GA(2)
7500	C2225A752(1)2GA(2)
8200	C2225A822(1)2GA(2)
100 VOLT - BP	
9100	C2225A912(1)1GA(2)
10,000	C2225A103(1)1GA(2)
11,000	C2225A113(1)1GA(2)
12,000	C2225A123(1)1GA(2)
13,000	C2225A133(1)1GA(2)
15,000	C2225A153(1)1GA(2)
16,000	C2225A163(1)1GA(2)
18,000	C2225A183(1)1GA(2)
20,000	C2225A203(1)1GA(2)
22,000	C2225A223(1)1GA(2)
50 VOLT - BP	
24,000	C2225A243(1)5GA(2)
27,000	C2225A273(1)5GA(2)
33,000	C2225A333(1)5GA(2)

CAPACITANCE pF	KEMET PART NUMBER
200 VOLT - BX	
18,000	C2225A183(1)2XA(2)
22,000	C2225A223(1)2XA(2)
27,000	C2225A273(1)2XA(2)
33,000	C2225A333(1)2XA(2)
39,000	C2225A393(1)2XA(2)
47,000	C2225A473(1)2XA(2)
100 VOLT - BX	
56,000	C2225A563(1)1XA(2)
68,000	C2225A683(1)1XA(2)
82,000	C2225A823(1)1XA(2)
100,000	C2225A104(1)1XA(2)
120,000	C2225A124(1)1XA(2)
150,000	C2225A154(1)1XA(2)
180,000	C2225A184(1)1XA(2)
50 VOLT - BX	
220,000	C2225A224(1)5XA(2)
270,000	C2225A274(1)5XA(2)
330,000	C2225A334(1)5XA(2)
390,000	C2225A394(1)5XA(2)
470,000	C2225A474(1)5XA(2)
560,000	C2225A564(1)5XA(2)
680,000	C2225A684(1)5XA(2)
820,000	C2225A824(1)5XA(2)
1,000,000	C2225A105(1)5XA(2)

(1) Complete KEMET part number by inserting capacitance tolerance, as applicable as shown in ordering information on page 17. **BP CAPACITANCE TOLERANCE:** ±1%, ±2%, ±5%, ±10%, ±20% (±0.5pF & ±0.25pF tolerances available 1.0 thru 10pF only) **TEMPERATURE CHARACTERISTIC "G"** **BX CAPACITANCE TOLERANCE:** ±5%, ±10%, ±20% **TEMPERATURE CHARACTERISTIC "X"**

(2) Complete part number by inserting end Metallization, as applicable as shown in ordering information on page 17.