

Chip Resistors

Pulse Withstanding

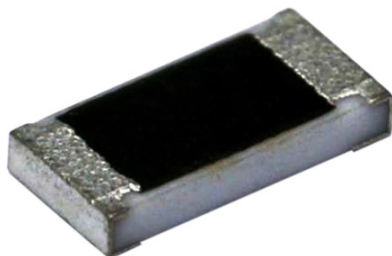

Features:

- Tolerance from $\pm 0.5\%$ to 5%
- High power rating
- Excellent pulse withstanding performance
- Improved working voltage ratings
- Standard package sizes of 0603 to 2512

Applications:

- Metering (Testing/Measurement)
- Diagnostic Equipment
- Medical Devices
- Industrial Controls
- Plasma
- LCD Video Monitors

Construction:

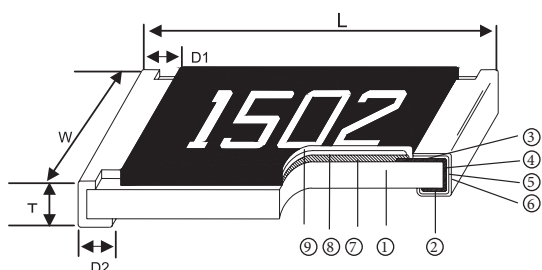

①	Alumina Substrate
②	Bottom Electrode (Ag)
③	Top Electrode (Ag-Pd)
④	Edge Electrode (NiCr)
⑤	Barrier Layer (Ni)
⑥	External Electrode (Sn)
⑦	Resistor Layer (RuO_2 / Ag)
⑧	Primary Overcoat (Glass)
⑨	Secondary Overcoat (Epoxy)

Dimensions:

Part Number	Size (Inch)	L	W	T	D1	D2	Weight (g) (1,000 pieces)
MCPWR05	0805	2 ± 0.1	1.25 ± 0.1	0.5 ± 0.1	0.35 ± 0.2	0.4 ± 0.2	4.368
MCPWR06	1206	3.1 ± 0.1	1.55 ± 0.1	0.55 ± 0.1	0.5 ± 0.25	0.5 ± 0.2	8.947
MCPWR10	2010	5 ± 0.1	2.5 ± 0.15		0.6 ± 0.25		24.241
MCPWR12	2512	6.35 ± 0.1	3.1 ± 0.15				39.448

Dimensions : Millimetres



Chip Resistors

Pulse Withstanding



Derating Curve:

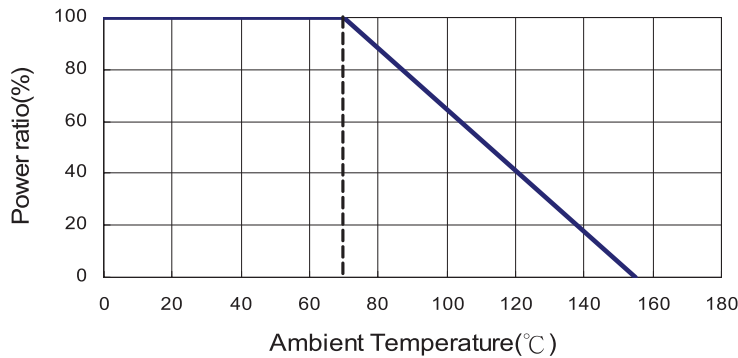

Standard Electrical Specifications:

Item Type	Power Rating at 70°C	Operating Temperature Range	Maximum Operating Voltage	Resistance Range					TCR (PPM/°C)
				±0.5%	±1%	±2%	±3%	±5%	
MCPWR05 (0805)	1/8W	-55 to +155°C	150V	10Ω - 299Ω	1Ω - 299Ω			±200	
				300Ω - 20MΩ					±100
MCPWR06 (1206)	1/3W		200V	10Ω - 20Ω	1Ω - 20Ω			±200	
				20.1Ω - 20MΩ					±100
MCPWR10 (2010)	3/4W		400V	10Ω - 20Ω	1Ω - 20Ω			±200	
				20.1Ω - 20MΩ					±100
MCPWR12 (2512)	1.5W		500V	10Ω - 20Ω	1Ω - 20Ω			±200	
				20.1Ω - 20 MΩ					±100

High Power Rating Electrical Specifications:

Item Type	Power Rating at 70°C	Operating Temperature Range	Maximum Operating Voltage	Resistance Range		TCR (PPM/°C)
				±1%	±5%	
MCPWR05 (0805)	1/4W	-55 to +155°C	150V	1Ω - 299Ω		±200
				300Ω - 20MΩ		±100
MCPWR06 (1206)	1/2W		200V	1Ω - 20Ω		±200
				20.1Ω - 20MΩ		±100
MCPWR10 (2010)	1W		400V	1Ω - 20Ω		±200
				20.1Ω - 20MΩ		±100

Operating voltage = $\sqrt{P \times R}$ or maximum operating voltage listed above, whichever is lower.

Overload voltage = $2.5 \times \sqrt{P \times R}$ or maximum overload voltage listed above, whichever is lower.



Chip Resistors

Pulse Withstanding



Soldering Condition:

Pulse Withstanding Chip Resistor

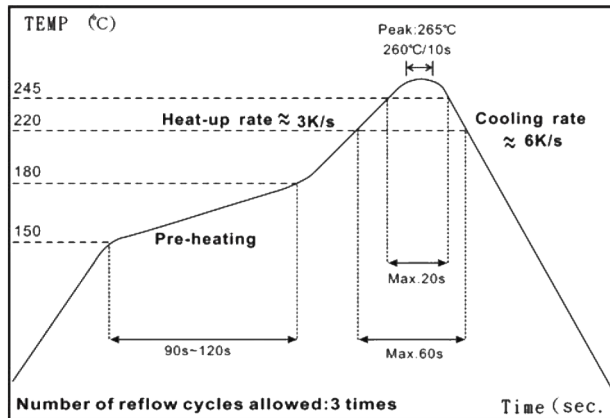

IR Reflow Soldering

(1) Time of IR reflow soldering at maximum temperature point 260°C : 10s

Environmental Characteristics:

Item	Requirement	Test Method
Temperature Coefficient of Resistance (TCR)	As specification	+25 / -55 / +25 / +125 / +25°C
Short Time Overload	±1%	RCWW × 2.5 or maximum overload voltage for 5s
Insulation Resistance	> 1,000MΩ	Apply 100V DC for 1mins
Endurance	±1%	70 ±2°C, maximum working voltage for 1,000hrs with 1.5hrs "ON" and 0.5hrs "OFF"
Damp Heat with Load	±0.5%	40 ±2°C, 90 to 95% R H maximum working voltage for 1,000hrs with 1.5hrs "ON" and 0.5hrs "OFF"
Dry Heat	±0.5%	at +155°C for 1,000hrs
Bending Strength	±1%	Bending amplitude 3mm for 10s
Solderability	95% minimum coverage	245 ±5°C for 3s
Resistance to Soldering Heat	±0.5%	260 ±5°C for 10s
Thermal Shock		-55°C to 150°C, 100 cycles
Low Temperature Operation		1hr, -65°C followed by 45mins of RCWW



Chip Resistors

Pulse Withstanding



Packaging:

Reel Specifications & Packaging Quantity

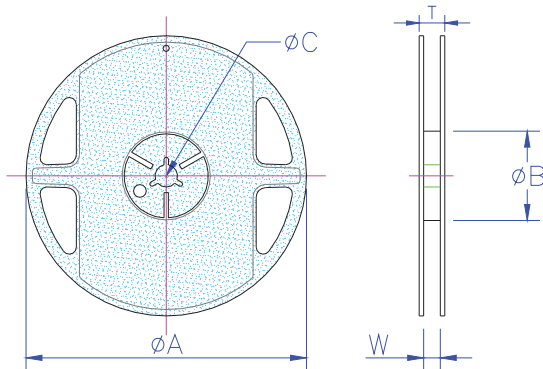

Part Number	Packaging Quantity		Tape Width	Reel Diameter (Inches)	ϕA	ϕB	ϕC	W	T
MCPWR05 MCPWR06	Paper	10K	8mm	10	254 ±1	100 ±0.5	13 ±0.2	9.5 ±0.5	13.5 ±0.5
MCPWR10	Embossed	4K	12mm	7	178.5 ±1.5	60+1/-0	13 ±0.5	13 ±0.5	15.5 ±0.5
MCPWR12		8K		10	250 ±1	62 ±0.5		12.5 ±0.5	16.5 ±0.5

Dimensions : Millimetres

Paper Tape Specifications

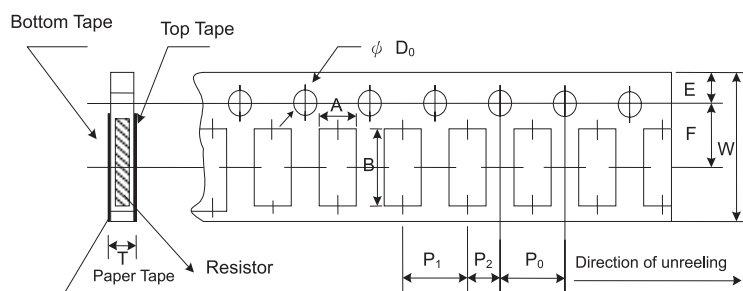

Part Number	A	B	W	E	F	P ₀	P ₁	P ₂	ϕD_0	T
MCPWR05	1.6 ±0.1	2.4 ±0.2	8 ±0.2	1.75 ±0.1	3.5 ±0.05	4 ±0.1	4 ±0.05	2 ±0.05	1.5+0.1,-0	0.85 ±0.1
MCPWR06	1.9 ±0.1	3.5 ±0.2								

Dimensions : Millimetres



Chip Resistors Pulse Withstanding



Embossed Plastic Tape Specifications

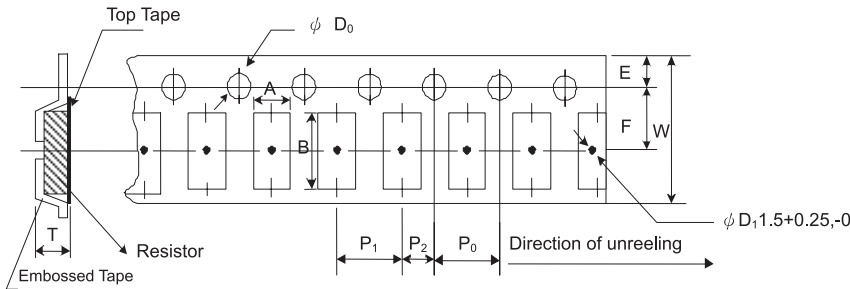

Part Number	A	B	W	E	F	P ₀	P ₁	P ₂	ØD ₀	T
MCPWR10	2.8 ±0.1	5.5 ±0.1	12 ±0.3	1.75 ±0.1	5.5 ±0.05	4 ±0.1	4 ±0.1	2 ±0.05	1.5+0.1,-0	1.2+0
MCPWR12	3.5 ±0.1	6.7 ±0.1								

Dimensions : Millimetres

Marking:

0805 to 2512 4 Digits Marking For Example

Resistance	100Ω	2.2kΩ	10kΩ	49.9kΩ	100kΩ
Marking	1,000	2,201	1,002	4,992	1,003

3 Digits Marking in E24

Example: 101 = 100Ω 102 = 1kΩ (1st and 2nd are E24 code and 3rd code is multiplier)

E24 Code	10	11	12	13	15	16	18	20	22	24	27	30	33	36	39	43	47	51	56	62	68	75	82	91
----------	----	----	----	----	----	----	----	----	----	----	----	----	----	----	----	----	----	----	----	----	----	----	----	----

1% for 0603: 3 Digits Marking in E96 (E96 Series Except E24 Series)

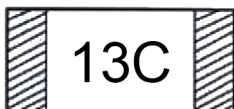

3 Digits Marking for Example: 13C = 13K3Ω 68B = 4K99Ω 68X = 49.9Ω

Chip Resistors

Pulse Withstanding



Marking Table:

Code	E96	Code	E96	Code	E96	Code	E96
02	102	28	191	52	340	75	590
03	105	29	196	53	348	76	604
04	107	31	205	54	357	77	619
06	113	32	210	55	365	78	634
07	115	33	215	56	374	79	649
08	118	34	221	57	383	80	665
09	121	35	226	58	392	81	681
10	124	36	232	59	402	82	698
11	127	37	237	60	412	83	715
13	133	38	243	61	422	84	732
14	137	39	249	62	432	86	768
15	140	40	255	63	442	87	787
16	143	41	261	64	453	88	806
17	147	42	267	65	464	89	825
19	154	43	274	66	475	90	845
20	158	44	280	67	487	91	866
21	162	45	287	68	499	92	887
22	165	46	294	69	511	93	909
23	169	47	301	70	523	94	931
24	174	48	309	71	536	95	953
25	178	49	316	72	549	96	976
26	182	50	324	73	562	-	-
27	187	51	332	74	576	-	-

Code	A	B	C	D	E	F	G	X	Y
Multiplier	10 ⁰	10 ¹	10 ²	10 ³	10 ⁴	10 ⁵	10 ⁶	10 ⁻¹	10 ⁻²

Chip Resistors

Pulse Withstanding



Recommend Land Pattern:

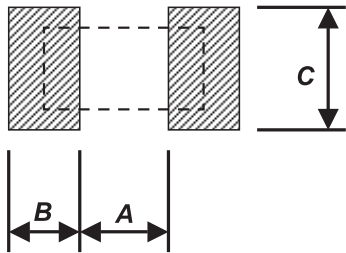

Type	A	B	C
MCPWR05	1.2	0.7	1.3
MCPWR06	2	0.9	1.6
MCPWR10	3.8		2.8
MCPWR12		1.6	3.5

Dimensions : Millimetres

Part Number Explanation:

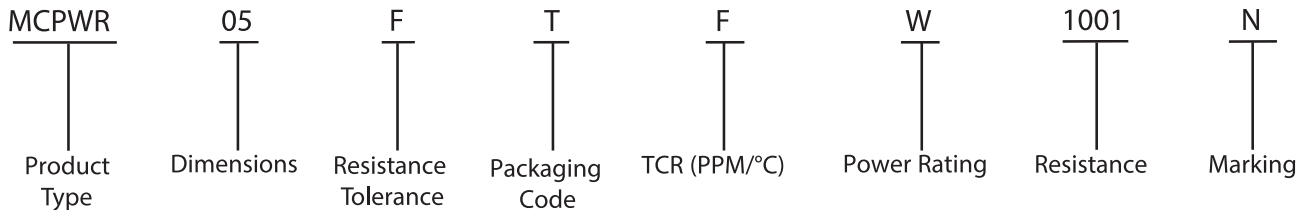

- Dimensions : 05 = 0805, 06 = 1206, 10 = 2010 and 12 = 2512
- Resistance Tolerance : F = ±1%
- Packaging Code : T = Taping Reel
- TCR (PPM/°C) : E = ±100, F = ±200
- Power Rating : A = 1.5W, O = 1/3W, Q = 3/4W and W = 1/8W
- Resistance : 1001 = 1kΩ, 1004 = 1MΩ and 1005 = 10MΩ
- Marking : Standard Marking, N = No Marking



Chip Resistors

Pulse Withstanding



Lightning Surge:

Resistors are tested in accordance with IEC 60 115-1 using both 1.2/50us and 10/700 pulse shapes. The limit of acceptance is a shift in resistance of less than 1% from the initial value.

PWR Series 1.2/50us Lightning Surge

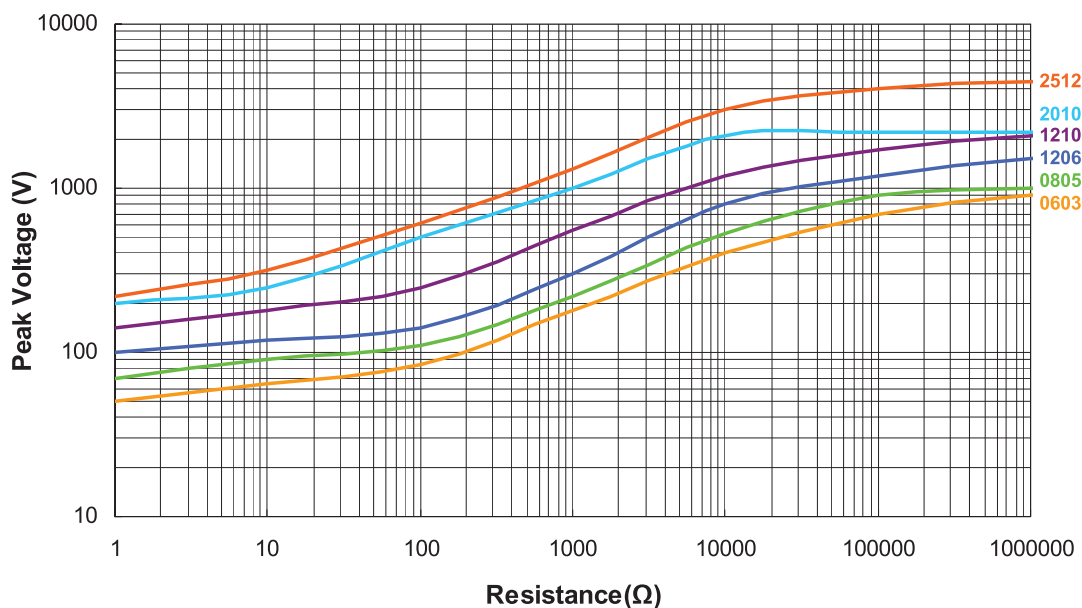

PWR Series 10/700us Lightning Surge

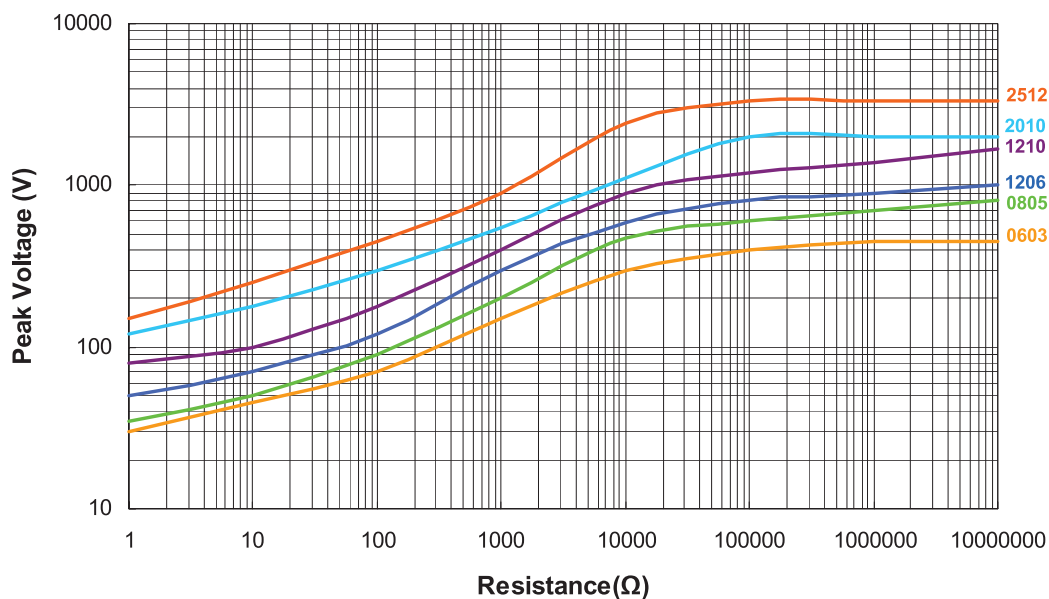

Chip Resistors

Pulse Withstanding



Pulse Withstanding Capacity:

The single impulse graph is the result of 50 impulses of rectangular shape applied at one-minute intervals. The limit of acceptance was a shift in resistance of less than 1% from the initial value. The power applied was subject to the restrictions of the maximum permissible impulse voltage graph shown.

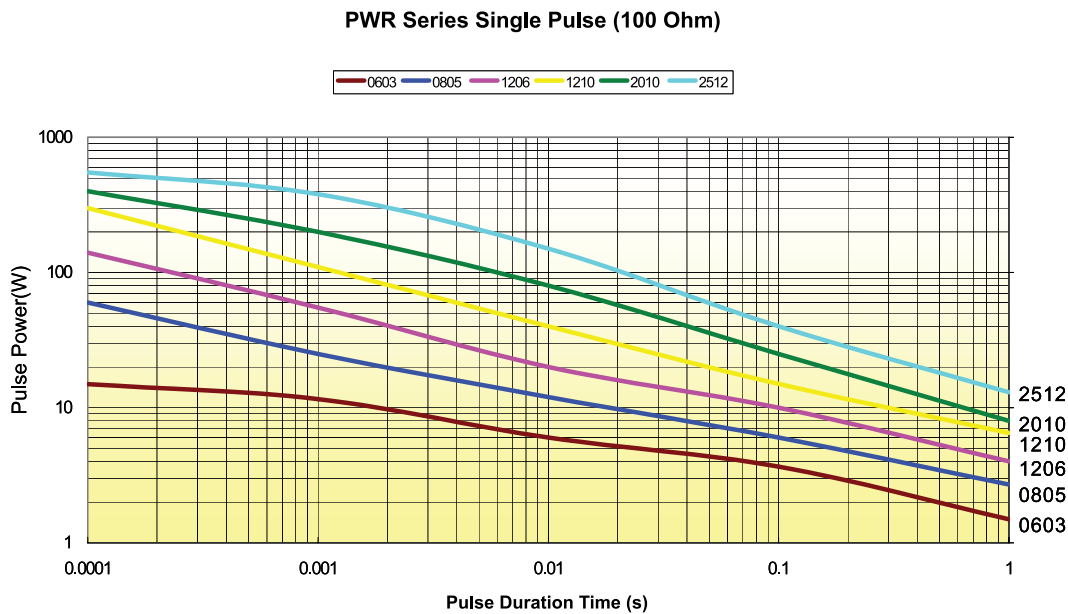

Continuous Pulse:

The continuous load graph was obtained by applying repetitive rectangular pulses where the pulse period was adjusted so that the average power dissipated in the resistor was equal to its rated power at 70°C. Again the limit of acceptance was a shift in resistance of less than 1% from the initial value.

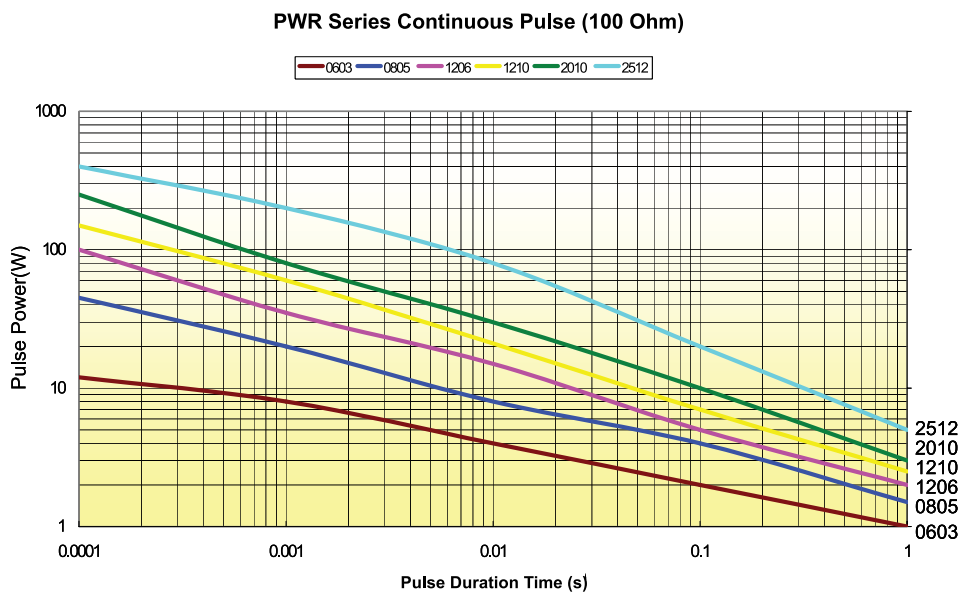

Chip Resistors

Pulse Withstanding



PWR Series Pulse Voltage(100 Ohm)

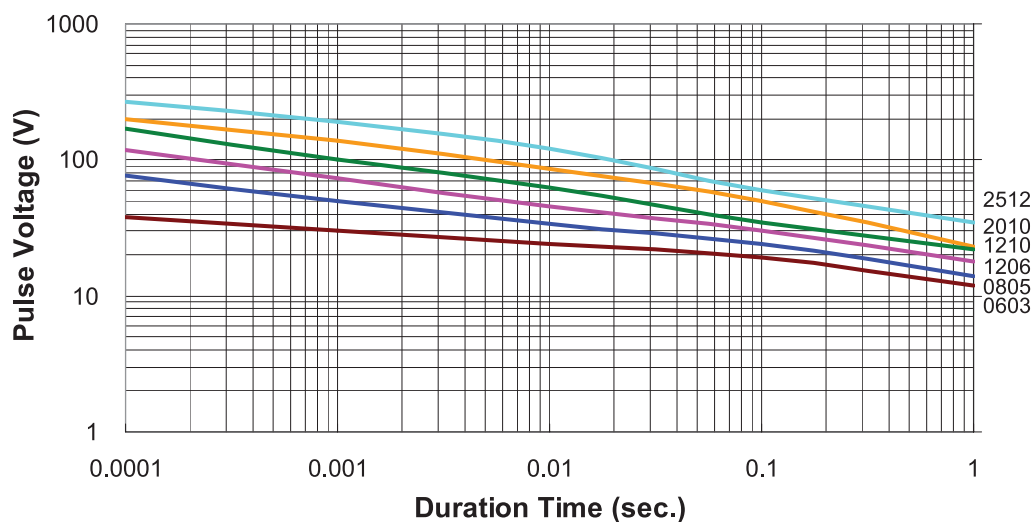

Important Notice : This data sheet and its contents (the "Information") belong to the members of the Premier Farnell group of companies (the "Group") or are licensed to it. No licence is granted for the use of it other than for information purposes in connection with the products to which it relates. No licence of any intellectual property rights is granted. The Information is subject to change without notice and replaces all data sheets previously supplied. The Information supplied is believed to be accurate but the Group assumes no responsibility for its accuracy or completeness, any error in or omission from it or for any use made of it. Users of this data sheet should check for themselves the Information and the suitability of the products for their purpose and not make any assumptions based on information included or omitted. Liability for loss or damage resulting from any reliance on the Information or use of it (including liability resulting from negligence or where the Group was aware of the possibility of such loss or damage arising) is excluded. This will not operate to limit or restrict the Group's liability for death or personal injury resulting from its negligence. Multicomp is the registered trademark of the Group. © Premier Farnell plc 2012.

