

SERIES PCA, PCAA ATTENUATORS, CHIP

Low Power – DC-18 GHz



FEATURES

- Laser Trimmed
- Temperature Stable

GENERAL INFORMATION

The PCA and PCAA Series consists of a laser trimmed distributed thin film element on an alumina ceramic substrate with solderable terminals. Two sizes are available. The PCA size operates to 12.4 GHz and the PCAA size operates to 18.0 GHz. Both sizes are available with leads and wrap around conductors for ease of installation. The PCAF and PCAAF options are designed for "flip-chip" application in lower frequency circuits.

PCA & PCAA SERIES DATA

- Substrate: 96% Alumina
- Solderable Terminals: Electroplated Silver over Nickel
- Resistive Element: Proprietary Thin Film
- Wrap around Ground Terminal available, "W" option
- Wrap around-all terminals—"F" option
- Standard values 1, 2, 3, 4, 5, 6, 10, 20 dB
- Non-std. values available as special order

ORDERING INFORMATION

The attenuators listed are available in 1 dB increments from 1 through 20 dB. When ordering, to specify the correct part number for the desired attenuation value, select any of the series listed and add the attenuation value desired to the basic series designation.

Options (Note 4)

L = Lead/Tab (Gold Plated BeCu)

W = Wrap around ground only

F = Wrap around all terminals (flip-chip)

T = Tinned terminals (any terminal type) SN62

H = Tinned terminals (any terminal type) SN96

G = Gold plated terminals

EXAMPLE:

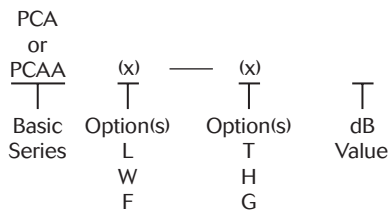

EXAMPLES: PCAW-T3
PCAAF-G3

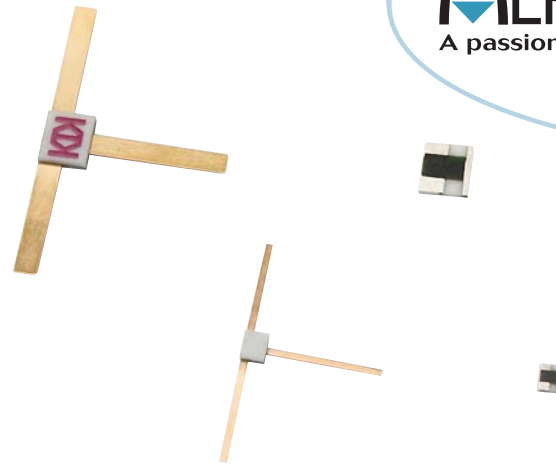

GENERAL SPECIFICATIONS

Impedance	50 Ohms
Operating Temperature	-55°C to +150°C
Attenuation Stability	0.0001 dB/dB/°C

AVERAGE POWER DERATING CURVE

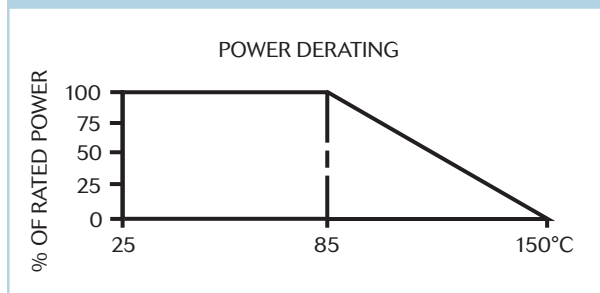

NOTES

1. Performance of other dB values vary dependent on attenuation. Contact factory for specifications for fractional dB values.
2. Performance is based on device mounted in matched 50 ohm line.
3. Rated power 1.5 watts input PCA, 100 mw PCAA.
4. Tinning with SN96 "Lead Free" high temperature solder will maintain RoHS compliance.

PERFORMANCE SPECIFICATIONS

Attenuation Increments (dB) Note 1	Attenuation Accuracy (dB) Note 2				VSWR (Typical) Note 2			
	DC - 4 GHz PCA, PCAA Series	4 - 8 GHz PCA, PCAA Series	8 - 12.4 GHz PCA, PCAA Series	12.4 - 18 GHz PCAA Series Only	DC - 4 GHz PCA, PCAA Series	4 - 8 GHz PCA, PCAA Series	8 - 12.4 GHz PCA, PCAA Series	12.4 - 18 GHz PCAA Series Only
1 - 3	0.5	0.5	0.5	0.5	1.25	1.35	1.50	1.50
4 - 6	0.5	0.5	0.5	0.75	1.25	1.35	1.50	1.50
7 - 10	0.5	0.5	0.75	1.0	1.25	1.35	1.50	1.50
11 - 15	0.75	+0.5 -3.0	+0.5 -4.0	—	1.25	1.35	1.50	—
16 - 20	1.0	+0.5 -4.0	—	—	1.25	1.35	—	—

KEY: Inches [Millimeters] .XX ±.03 .XXX ±.010 [X ±0.8 .XX ±0.25]

SERIES PCA, PCAA ATTENUATORS, CHIP

Low Power – DC-18 GHz

PHYSICAL DIMENSIONS

PCA

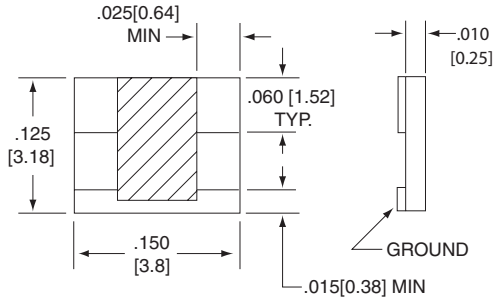

PCAW

(WRAP AROUND GROUND TERMINAL ONLY)

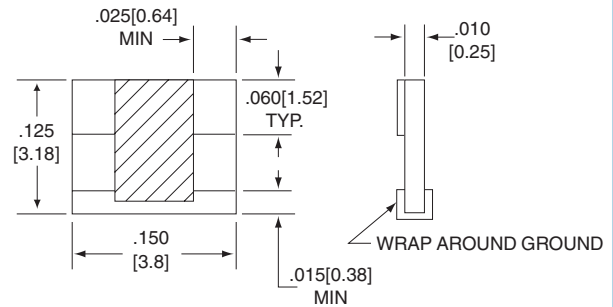

PCAL (LEAD/COVER)

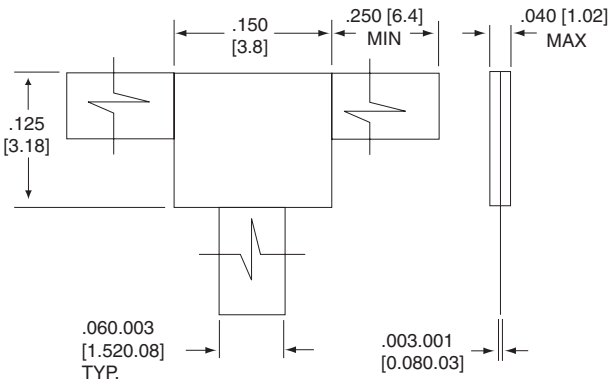

PCAF (WRAP AROUND ALL TERMINALS)

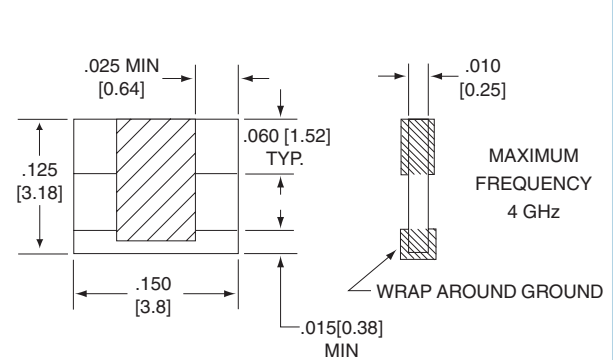

PCAA

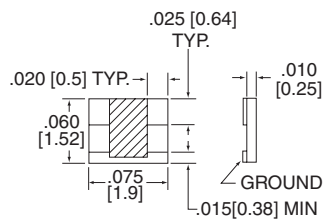

PCAAW

(WRAP AROUND GROUND TERMINAL ONLY)

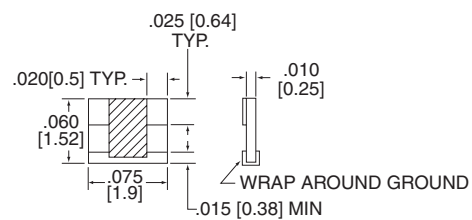

PCAAL (LEAD/COVER)

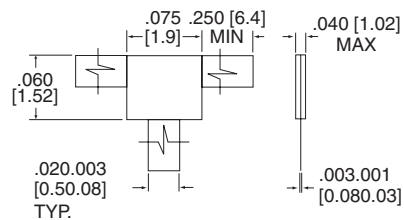

PCAALF (WRAP AROUND ALL TERMINALS)

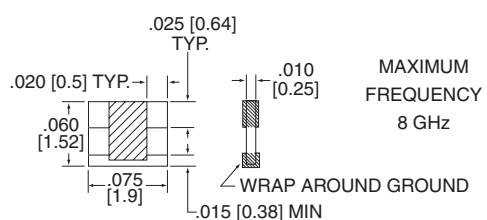

KEY: Inches [Millimeters] .XX ±.03 .XXX ±.010 LX ±0.8 .XX ±0.25]