

ATF-50189

Enhancement Mode^[1] Pseudomorphic HEMT in SOT 89 Package



Data Sheet

Description

Avago Technologies's ATF-50189 is a high linearity, medium power, low noise E-pHEMT FET packaged in a low cost surface mount SOT89^[3] package. The combination of low noise figure and high output IP3 at the same bias point makes it ideal for receiver and transmitter application. Its operating frequency range is from 400 MHz to 3.9 GHz.

The ATF-50189 is ideally suited for Cellular/PCS and WCDMA wireless infrastructure, WLAN, WLL and MMDS application, and general purpose discrete E-pHEMT amplifiers which require high linearity and power. All devices are 100% RF and DC tested.

Notes:

1. Enhancement mode technology employs a single positive V_{gs}, eliminating the need of negative gate voltage associated with conventional depletion mode devices.
2. Refer to reliability datasheet for detailed MTTF data
3. Conform to JEDEC reference outline MO229 for DRP-N
4. Linearity Figure of Merit (LFOM) is OIP3 divided by DC bias power

Pin Connections and Package Marking

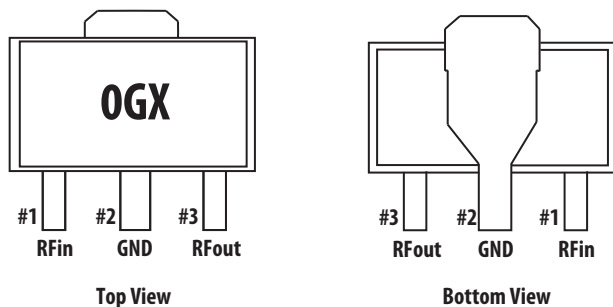

Notes:

Package marking provides orientation and identification:
 "OG" = Device Code
 "x" = Month code indicates the month of manufacture.

Features

- High Linearity and P1dB
- Low Noise Figure
- Excellent uniformity in product specifications
- SOT 89 standard package
- Point MTTF > 300 years^[2]
- MSL-2 and lead-free
- Tape-and-Reel packaging option available

Specifications

2 GH, 4.5V, 280 mA (Typ.)

- 45 dBm Output IP3
- 29 dBm Output Power at 1dB gain compression
- 1.1 dB Noise Figure
- 15.5 dB Gain
- 62% PAE at P1dB
- LFOM^[4] 14 dB

Applications

- Front-end LNA Q2 and Q3, Driver or Pre-driver Amplifier for Cellular/PCS and WCDMA wireless infrastructure
- Driver Amplifier for WLAN, WLL/RLL and MMDS applications
- General purpose discrete E-pHEMT for other high linearity applications



Attention: Observe precautions for handling electrostatic sensitive devices.
 ESD Machine Model (Class A)
 ESD Human Body Model (Class 1C)
 Refer to Avago Application Note A004R:
 Electrostatic Discharge Damage and Control.

ATF-50189 Absolute Maximum Ratings^[1]

Symbol	Parameter	Units	Absolute Maximum
V _{DS}	Drain–Source Voltage ^[2]	V	7
V _{GS}	Gate–Source Voltage ^[2]	V	-5 to 0.8
V _{GD}	Gate Drain Voltage ^[2]	V	-5 to 1
I _{DS}	Drain Current ^[2]	A	1
I _{GS}	Gate Current	mA	12
P _{diss}	Total Power Dissipation ^[3]	W	2.25
P _{in}	RF Input Power	dBm	30
T _{CH}	Channel Temperature	°C	150
T _{STG}	Storage Temperature	°C	-65 to 150

Thermal Resistance^[2,4]

$$\theta_{ch_b} = 29^{\circ}\text{C}/\text{W}$$

Notes:

1. Operation of this device above any one of these parameters may cause permanent damage.
2. Assumes DC quiescent conditions.
3. Board (package belly) temperature T_B is 25°C. Derate 35 mW/°C for T_B > 85°C.
4. Channel-to-board thermal resistance measured using 150°C Liquid Crystal Measurement method.

ATF-50189 Electrical Specifications

T_A = 25°C, DC bias for RF parameters is V_{ds} = 4.5V and I_{ds} = 280 mA unless otherwise specified.

Symbol	Parameter and Test Condition	Units	Min.	Typ.	Max.	
V _{gs}	Operational Gate Voltage	V _{ds} = 4.5V, I _{ds} = 280 mA	V	0.37	0.53	0.72
V _{th}	Threshold Voltage	V _{ds} = 4.5V, I _{ds} = 32 mA	V	—	0.38	—
I _{dss}	Saturated Drain Current	V _{ds} = 4.5V, V _{gs} = 0V	μA	—	4.1	—
G _m	Transconductance	V _{ds} = 4.5V, G _m = ΔI _{ds} /ΔV _{gs} ; ΔV _{gs} = V _{gs1} – V _{gs2} V _{gs1} = 0.55V, V _{gs2} = 0.5V	mmho	175	2294	—
I _{gss}	Gate Leakage Current	V _{ds} = 0V, V _{gs} = -4.5V	μA	—	13.8	60
NF	Noise Figure ^[1]	f = 2 GHz f = 900 MHz	dB dB	— —	1.1 1.0	— —
G	Gain ^[1]	f = 2 GHz f = 900 MHz	dB dB	14 —	15.5 21.5	17 —
OIP3	Output 3 rd Order Intercept Point ^[1,2]	f = 2 GHz f = 900 MHz	dBm dBm	43 —	45 44	— —
P1dB	Output Power at 1dB Compression Point ^[1]	f = 2 GHz f = 900 MHz	dBm dBm	27 —	29 28.5	— —
PAE	Power Added Efficiency ^[1] at P1dB	f = 2 GHz f = 900 MHz	% %	45 —	62 49	— —
ACLR	Adjacent Channel Leakage Power Ratio ^[1,3]	Offset BW = 5 MHz Offset BW = 10 MHz	dBc dBc	— —	60.0 67.8	— —

Notes:

1. Measurements at 2 GHz obtained using production test board described in Figure 1 while measurement at 900 MHz obtained from double stub tuners.
2. i) 2 GHz OIP3 test condition: F1 = 2 GHz, F2 = 2.005 GHz and Pin = -5 dBm per tone.
ii) 900 MHz OIP3 test condition: F1 = 900 MHz, F2 = 905 MHz and Pin = -5 dBm per tone.
3. ACLR test spec is based on 3GPP TS 25.141 V5.3.1 (2002-06)
 - Test Model 1
 - Active Channels: PCCPCH + SCH + CPICH + PICH + SCCPCH + 64 DPCH (SF=128)
 - Freq = 2140 MHz
 - Pin = -5 dBm
 - Channel Integrate Bandwidth = 3.84 MHz

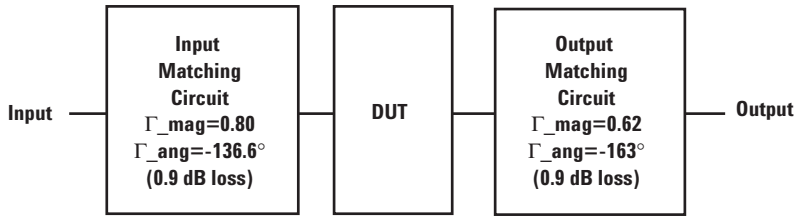

Figure 1. Block diagram of the 2 GHz production test board used for NF, Gain, OIP3, P1dB, PAE and ACLR measurements. This circuit achieves a trade-off between optimal OIP3, P1dB and VSWR. Circuit losses have been de-embedded from actual measurements.

Product Consistency Distribution Charts^[1,2]

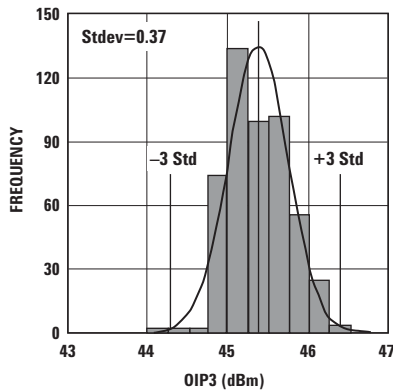

Figure 2. OIP3 @ 2 GHz, 4.5V/280 mA.
LSL = 43.0, Nominal = 45.4

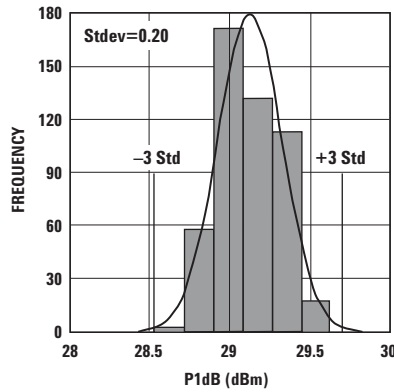

Figure 3. P1dB @ 2 GHz, 4.5V/280 mA.
LSL = 27.0, Nominal = 29.0

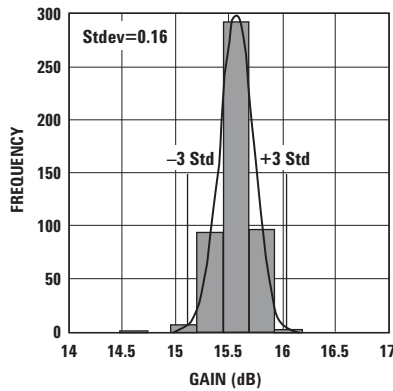

Figure 4. Gain @ 2 GHz, 4.5V/200 mA.
LSL = 14.0, Nominal = 15.5, USL = 17.0

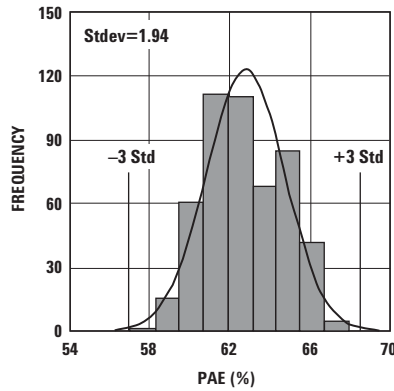

Figure 5. PAE at P1dB @ 2 GHz, 4.5V/200 mA.
LSL = 45.0, Nominal = 62.0

Notes:

1. Distribution data sample size is 500 samples taken from 5 different wafers. Future wafers allocated to this product may have nominal values anywhere between the upper and lower limits.
2. Measurements are made on production test board, which represents a trade-off between optimal OIP3, P1dB and VSWR. Circuit losses have been de-embedded from actual measurements.

Gamma Load and Source at Optimum OIP3 and P1dB Tuning Conditions

The device's optimum OIP3 and P1dB measurements were determined using a load pull system at 4.5V, 280 mA quiescent bias.

Typical Gammas at Optimum OIP3^[1]

Freq (GHz)	Gamma Source		Optimum OIP3		OIP3 (dBm)	Gain (dB)	P1dB (dBm)	PAE (%)
	Mag	Ang (deg)	Gamma Load Mag	Gamma Load Ang (deg)				
0.45	0.47	121.7	0.76	-175.1	41.0	22.0	27.5	39.0
0.9	0.81	-157.5	0.72	-178.1	44.2	21.6	28.3	49.2
1.8	0.82	-110.4	0.62	-135.1	46.5	16.0	28.7	61.3
2	0.85	-106.4	0.64	-127.4	46.2	15.1	29.0	63.0
2.4	0.82	-88.8	0.67	-113.6	45.6	13.0	28.9	55.0
3.5	0.77	-49.6	0.59	-79.5	44.0	8.6	26.9	35.0

Typical Gammas at Optimum P1dB^[1]

Freq (GHz)	Gamma Source		Optimum P1dB		OIP3 (dBm)	Gain (dB)	P1dB (dBm)	PAE (%)
	Mag	Ang (deg)	Gamma Load Mag	Gamma Load Ang (deg)				
0.45	0.52	151.2	0.71	-177.5	39.8	23.9	28.5	44.8
0.9	0.79	-160.1	0.67	-158.3	42.8	20.1	30.4	56
1.8	0.83	-112.5	0.72	-131.2	44.2	15.9	30.3	60.3
2	0.82	-102.1	0.69	-117.5	44.8	14.9	30.2	58.6
2.4	0.78	-91.2	0.77	-105.3	44.44	12.5	30.2	54.1
3.5	0.78	-49.7	0.72	-74.6	43.7	8.7	27.3	32

Note:

1. Typical describes additional product performance information that is not covered by the product warranty.

Typical IV Curve

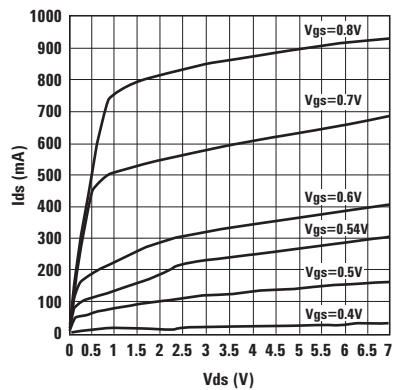

Figure 6. Typical IV curve.

**ATF-50189 Typical Performance Curves (at 25°C unless specified otherwise)
Tuned for Optimal OIP3 at $V_d = 4.5V$, $I_{ds} = 280\text{ mA}$, Operating Frequency = 2 GHz.**

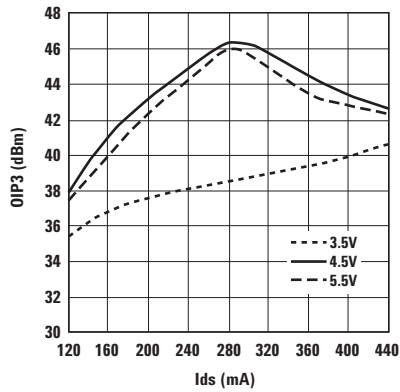

Figure 7. OIP3 vs. I_{ds} and V_{ds} at 2 GHz.

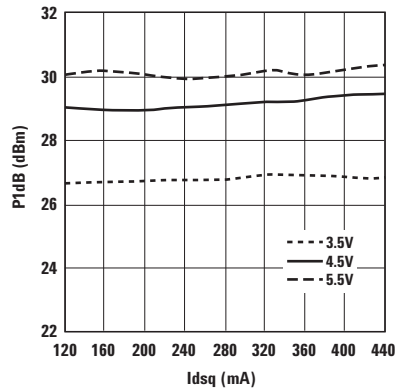

Figure 8. P1dB vs. I_{dsq} and V_{ds} at 2 GHz.

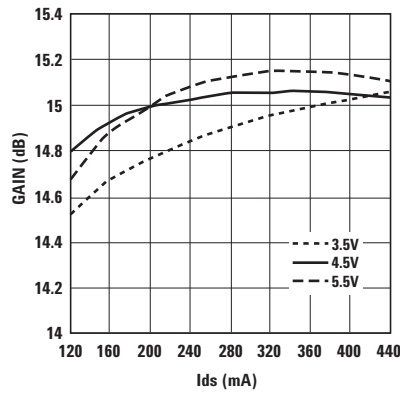

Figure 9. Gain vs. I_{ds} and V_{ds} at 2 GHz.

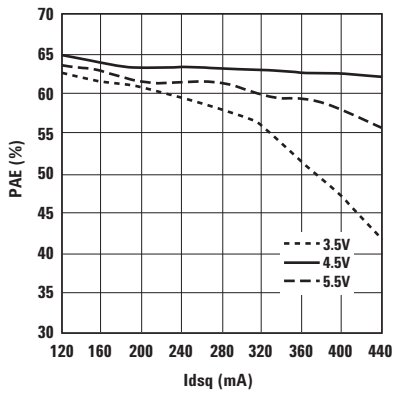

Figure 10. PAE vs. I_{dsq} and V_{ds} at 2 GHz.

ATF-50189 Typical Performance Curves, continued
Tuned for Optimal OIP3 at $V_d = 4.5V$, $I_{ds} = 280\text{ mA}$, Operating Frequency = 900 MHz.

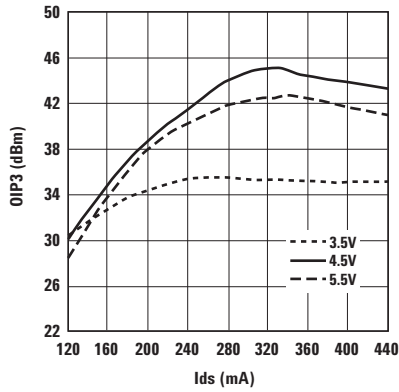

Figure 11. OIP3 vs. I_{ds} and V_{ds} at 900 MHz.

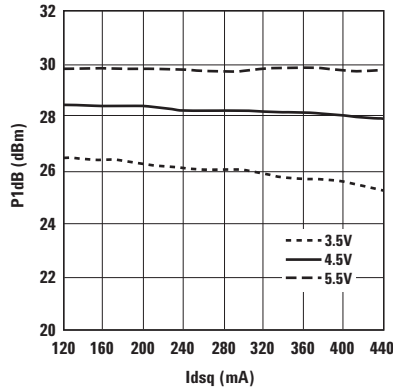

Figure 12. P1dB vs. I_{dsq} and V_{ds} at 900 MHz.

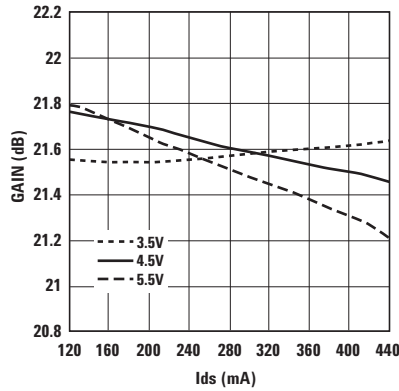

Figure 13. Gain vs. I_{ds} and V_{ds} at 900 MHz.

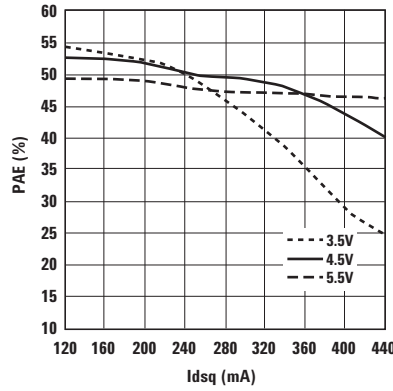

Figure 14. PAE vs. I_{dsq} and V_{ds} at 900 MHz.

ATF-50189 Typical Performance Curves, continued
Tuned for Optimal OIP3 at $V_d = 4.5V$, $I_{ds} = 280\text{ mA}$, Over Temperature and Frequency

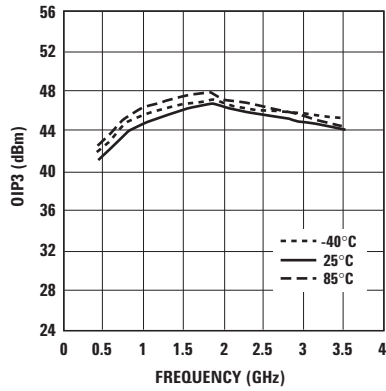

Figure 15. OIP3 vs. Temperature and Frequency at optimum OIP3.

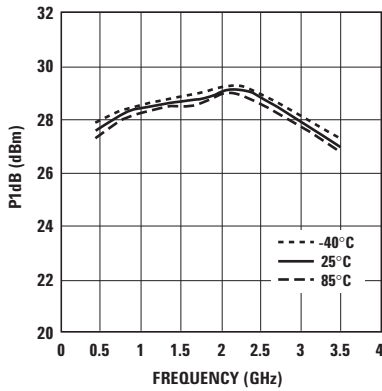

Figure 16. P1dB vs. Temperature and Frequency at optimum OIP3.

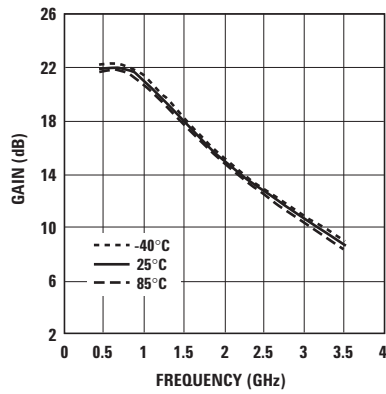

Figure 17. Gain vs. Temperature and Frequency at optimum OIP3.

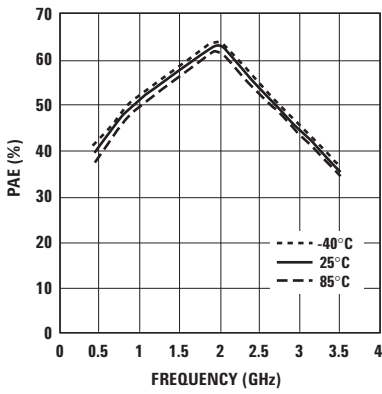

Figure 18. PAE vs. Temperature and Frequency at optimum OIP3.

ATF-50189 Typical Performance Curves, continued
Tuned for Optimal P1dB at $V_d = 4.5V$, $I_{ds} = 280\text{ mA}$, Operating Frequency = 2 GHz.

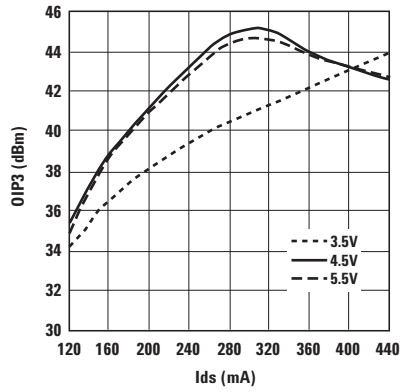

Figure 19. OIP3 vs. I_{ds} and V_{ds} at 2 GHz.

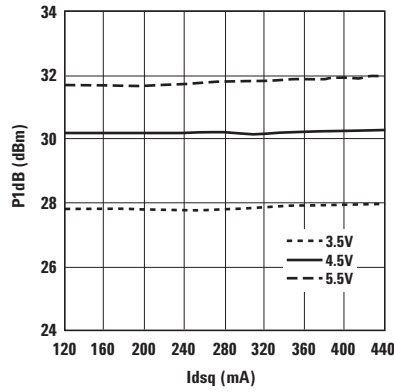

Figure 20. P1dB vs. I_{dsq} and V_{ds} at 2 GHz.

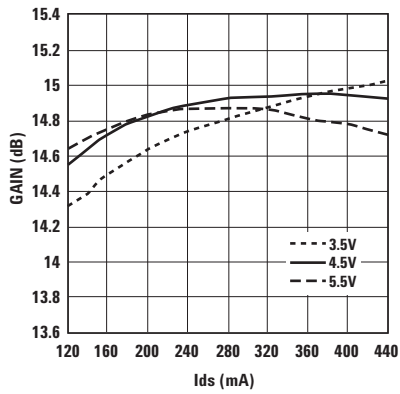

Figure 21. Gain vs. I_{ds} and V_{ds} at 2 GHz.

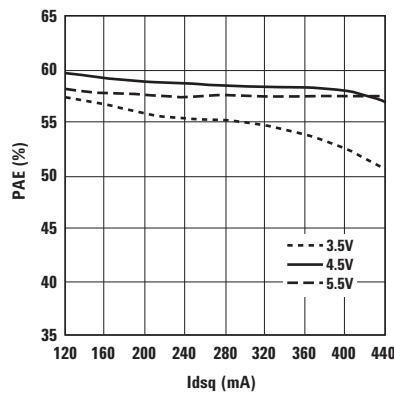

Figure 22. PAE vs. I_{dsq} and V_{ds} at 2 GHz.

ATF-50189 Typical Performance Curves, continued
Tuned for Optimal P1dB at $V_d = 4.5V$, $I_{ds} = 280\text{ mA}$, Operating Frequency = 900 MHz.

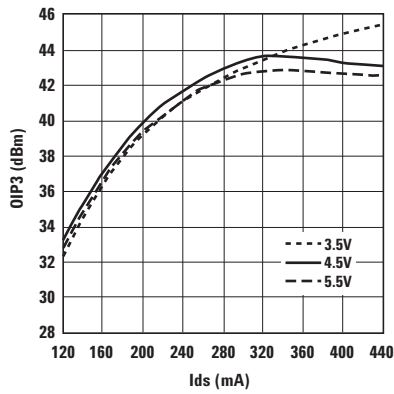

Figure 23. OIP3 vs. I_{ds} and V_{ds} at 900 MHz.

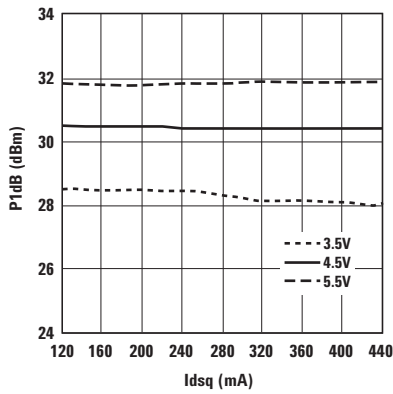

Figure 24. P1dB vs. I_{dsq} and V_{ds} at 900 MHz.

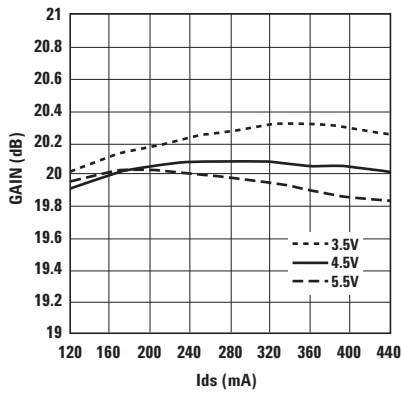

Figure 25. Gain vs. I_{ds} and V_{ds} at 900 MHz.

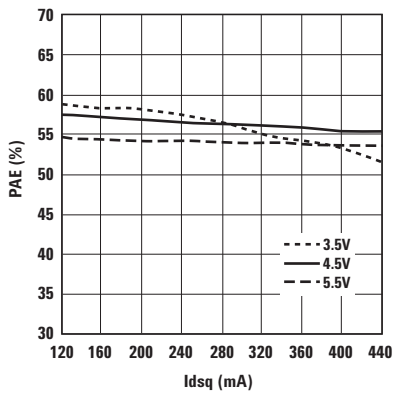

Figure 26. PAE vs. I_{dsq} and V_{ds} at 900 MHz.

ATF-50189 Typical Performance Curves, continued
Tuned for Optimal P1dB at $V_d = 4.5V$, $I_{ds} = 280\text{ mA}$, Over Temperature and Frequency

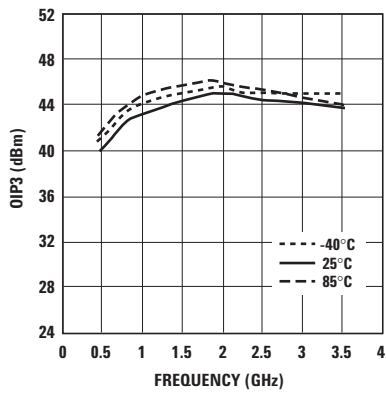

Figure 27. OIP3 vs. Temperature and Frequency at optimum P1dB.

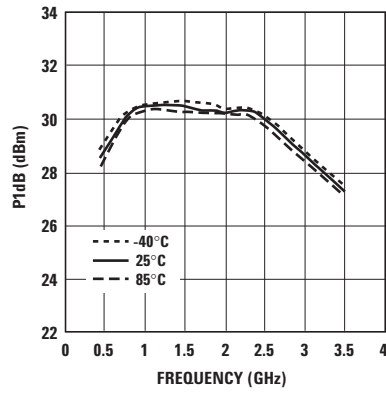

Figure 28. P1dB vs. Temperature and Frequency at optimum P1dB.

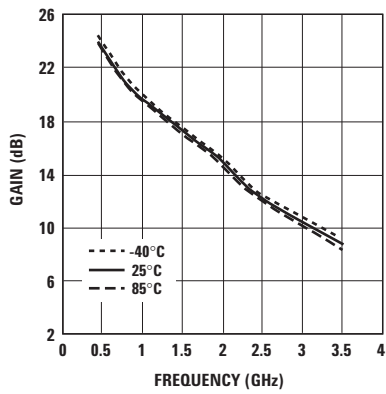

Figure 29. Gain vs. Temperature and Frequency at optimum P1dB.

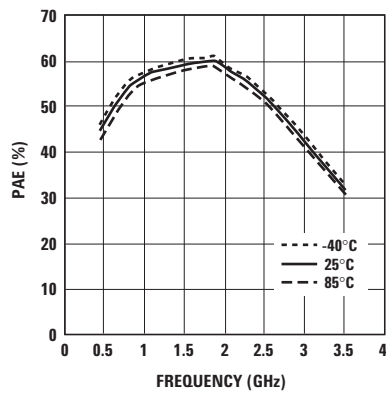
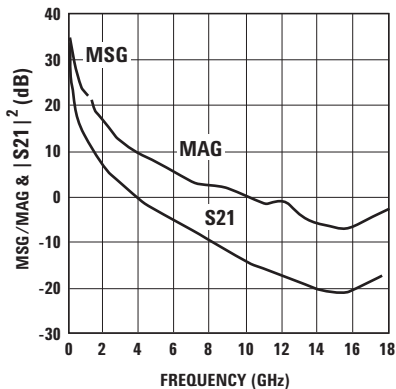

Figure 30. PAE vs. Temperature and Frequency at optimum P1dB.

ATF-50189 Typical Scattering Parameters at 25°C, $V_{DS} = 4.5V$, $I_{DS} = 280\text{ mA}$

Freq. GHz	S_{11}			S_{21}			S_{12}			S_{22}		MSG/MAG dB
	Mag.	Ang.	dB	Mag.	Ang.	dB	Mag.	Ang.	Mag.	Ang.		
0.1	0.923	-133.2	31.0	35.531	110.9	-37.7	0.013	31.7	0.692	-163.7	34.4	
0.2	0.919	-158.7	25.6	19.023	97.1	-37.1	0.014	25.2	0.738	-173.2	31.3	
0.3	0.919	-169.4	22.2	12.872	90.4	-36.5	0.015	24.9	0.749	-177.6	29.3	
0.4	0.917	-176.1	19.7	9.705	85.7	-35.9	0.016	26.3	0.752	179.3	27.8	
0.5	0.916	178.5	17.7	7.687	84.4	-35.4	0.017	30.4	0.756	175.7	26.6	
0.6	0.916	174.5	16.2	6.438	81.7	-34.9	0.018	32.6	0.755	173.5	25.5	
0.7	0.917	170.9	14.9	5.582	79.2	-34.4	0.019	34.5	0.755	171.4	24.7	
0.8	0.918	167.5	13.9	4.939	76.5	-33.6	0.021	35.9	0.753	169.4	23.7	
0.9	0.920	164.1	12.9	4.433	73.8	-33.2	0.022	36.8	0.755	167.5	23.0	
1.0	0.921	161.0	12.1	4.026	70.9	-32.4	0.024	37.1	0.753	165.6	22.2	
1.1	0.922	159.6	11.7	3.853	69.5	-32.0	0.025	37.1	0.753	164.7	21.9	
1.2	0.922	158.1	11.3	3.679	68.1	-32.0	0.025	37.1	0.753	163.7	21.7	
1.3	0.922	155.4	10.6	3.378	65.2	-31.4	0.027	36.7	0.751	162.0	21.0	
1.4	0.919	152.6	9.9	3.127	62.3	-31.1	0.028	36.3	0.753	160.2	20.3	
1.5	0.918	150.2	9.3	2.910	59.6	-30.5	0.030	35.8	0.753	158.4	19.2	
1.6	0.920	147.5	8.7	2.717	56.7	-30.2	0.031	35.0	0.753	156.7	18.5	
1.7	0.919	144.6	8.1	2.547	53.9	-29.6	0.033	34.1	0.753	154.9	17.8	
1.8	0.920	142.0	7.6	2.392	51.2	-29.4	0.034	33.2	0.753	153.3	17.2	
1.9	0.918	139.6	7.0	2.251	48.6	-29.1	0.035	32.1	0.752	151.7	16.5	
2.0	0.919	137.1	6.5	2.123	45.9	-28.6	0.037	31.0	0.752	150.1	16.0	
2.1	0.917	134.6	6.1	2.009	43.3	-28.4	0.038	29.7	0.752	148.3	15.4	
2.2	0.918	132.0	5.6	1.908	40.6	-28.2	0.039	28.6	0.752	146.8	15.0	
2.3	0.915	129.8	5.1	1.800	37.9	-28.0	0.040	27.4	0.755	145.2	14.4	
2.4	0.912	127.1	4.7	1.721	35.6	-27.7	0.041	26.0	0.750	143.9	13.9	
2.5	0.908	124.9	4.3	1.647	33.4	-27.3	0.043	25.0	0.768	142.3	13.4	
3	0.908	112.7	2.3	1.304	21.1	-26.6	0.047	18.3	0.766	135.5	11.5	
3.5	0.912	99.5	0.5	1.062	11.3	-26.0	0.050	12.6	0.773	131.8	10.0	
4	0.923	92.6	-0.7	0.921	1.5	-25.8	0.051	7.1	0.779	123.3	9.4	
5	0.922	78.2	-3.5	0.669	-19.8	-25.2	0.055	-5.3	0.793	102.9	7.0	
6	0.921	61.3	-5.8	0.515	-41.5	-25.7	0.052	-22.4	0.806	84.7	5.2	
7	0.921	41.2	-8.2	0.389	-59.6	-26.0	0.050	-39.5	0.809	69.9	3.2	
8	0.922	24.3	-10.2	0.308	-79.9	-26.7	0.046	-55.9	0.844	54.6	2.1	
9	0.923	11.8	-12.4	0.239	-100.5	-28.4	0.038	-73.5	0.882	37.0	1.4	
10	0.922	10.8	-14.6	0.187	-109.4	-31.1	0.028	-81.6	0.896	27.1	0.1	
11	0.921	0.3	-16.0	0.158	-124.9	-34.4	0.019	-108.3	0.872	20.3	-1.8	
12	0.924	-8.0	-17.7	0.131	-138.0	-46.0	0.005	-147.3	0.916	7.0	-1.3	
13	0.923	-12.1	-19.2	0.110	-153.4	-40.0	0.010	71.0	0.877	-1.1	-4.4	
14	0.922	-20.6	-21.0	0.089	-168.9	-37.1	0.014	30.2	0.882	-7.5	-6.3	
15	0.925	-23.6	-21.4	0.085	177.8	-39.2	0.011	-4.9	0.865	-19.2	-7.2	
16	0.925	-23.1	-21.1	0.088	165.9	-37.7	0.013	-8.8	0.864	-26.2	-6.9	
17	0.924	-24.3	-18.9	0.114	155.2	-41.9	0.008	-173.5	0.856	-33.6	-4.7	
18	0.924	-32.5	-17.1	0.140	133.4	-35.4	0.017	161.7	0.835	-42.5	-3.2	



Notes:

1. S parameter is measured on a microstrip line made on 0.025 inch thick alumina carrier. The input reference plane is at the end of the gate lead. The output reference plane is at the end of the drain lead.

Figure 31. MSG/MAG & $|S_{21}|^2$ vs Frequency at 4.5V/280 mA.

ATF-50189 Typical Scattering Parameters at 25°C, $V_{DS} = 4.5V$, $I_{DS} = 200\text{ mA}$

Freq. GHz	S_{11}		dB	S_{21}		dB	S_{12}		S_{22}		MSG/MAG dB
	Mag.	Ang.		Mag.	Ang.		Mag.	Ang.	Mag.	Ang.	
0.1	0.924	-131.8	31.0	35.392	111.6	-37.1	0.014	31.1	0.682	-161.3	34.0
0.2	0.918	-157.9	25.6	19.011	97.5	-35.9	0.016	23.7	0.731	-172.0	30.7
0.3	0.918	-168.9	22.2	12.87	90.7	-35.9	0.016	23.0	0.743	-176.8	29.1
0.4	0.917	-175.7	19.7	9.706	85.9	-35.4	0.017	23.9	0.746	-180.0	27.6
0.5	0.914	178.9	17.7	7.686	84.4	-34.9	0.018	27.7	0.749	176.2	26.3
0.6	0.914	174.8	16.2	6.438	81.8	-34.4	0.019	29.8	0.749	173.9	25.3
0.7	0.916	171.1	14.9	5.583	79.2	-34.0	0.020	31.7	0.749	171.8	24.5
0.8	0.917	167.7	13.9	4.94	76.5	-33.2	0.022	32.9	0.747	169.8	23.5
0.9	0.918	164.3	12.9	4.433	73.7	-32.8	0.023	33.8	0.748	167.8	22.8
1	0.918	161.2	12.1	4.025	70.9	-32.0	0.025	34.2	0.747	165.9	22.1
1.1	0.919	159.8	11.7	3.852	69.5	-31.7	0.026	34.2	0.747	165.0	21.7
1.2	0.920	158.3	11.3	3.679	68.0	-31.7	0.026	34.2	0.747	164.0	21.5
1.3	0.920	155.6	10.6	3.377	65.1	-31.4	0.027	34.0	0.746	162.3	21.0
1.4	0.917	152.7	9.9	3.126	62.2	-30.8	0.029	33.6	0.747	160.5	20.3
1.5	0.916	152.3	9.3	2.911	59.6	-30.5	0.030	33.3	0.747	158.7	19.9
1.6	0.920	147.7	8.7	2.718	56.6	-29.9	0.032	32.5	0.747	156.9	19.3
1.7	0.919	144.8	8.1	2.547	53.7	-29.6	0.033	31.7	0.747	155.1	18.1
1.8	0.918	142.2	7.6	2.392	51.1	-29.1	0.035	30.9	0.747	153.6	17.3
1.9	0.917	139.8	7.0	2.251	48.4	-28.9	0.036	29.9	0.747	151.9	16.6
2	0.918	137.2	6.5	2.122	45.7	-28.6	0.037	28.8	0.746	150.3	16.1
2.1	0.916	134.7	6.1	2.008	43.1	-28.4	0.038	27.7	0.747	148.6	15.5
2.2	0.917	132.1	5.6	1.907	40.4	-28.2	0.039	26.6	0.746	147.0	15.1
2.3	0.913	129.8	5.2	1.811	37.7	-28.0	0.040	25.3	0.745	145.7	14.4
2.4	0.911	127.2	4.7	1.72	35.3	-27.7	0.041	24.2	0.746	144.2	13.9
2.5	0.907	125.1	4.3	1.645	33.1	-27.3	0.043	23.2	0.762	142.5	13.5
3	0.918	112.7	2.3	1.303	20.9	-26.6	0.047	16.8	0.761	135.8	11.9
3.5	0.912	99.5	0.7	1.08	10.7	-26.0	0.050	12.6	0.798	131.8	10.4
4	0.923	92.6	-0.6	0.93	0.5	-26.0	0.050	6.2	0.799	122.0	9.7
5	0.922	78.2	-3.5	0.67	-20.4	-25.8	0.051	-6.7	0.800	102.3	7.2
6	0.921	61.3	-5.8	0.513	-42.1	-26.5	0.053	-26.9	0.808	84.7	5.3
7	0.921	41.2	-8.3	0.386	-60.0	-26.0	0.050	-40.1	0.809	69.9	3.1
8	0.922	24.3	-10.3	0.305	-80.4	-26.7	0.046	-56.8	0.843	54.8	2.1
9	0.923	11.8	-12.5	0.238	-101.3	-28.4	0.038	-74.6	0.881	37.1	1.3
10	0.922	10.8	-14.8	0.183	-108.5	-31.1	0.028	-82.9	0.895	27.3	-0.1
11	0.921	0.3	-16.0	0.158	-126.0	-34.4	0.019	-110.5	0.872	20.5	-1.7
12	0.924	-8.0	-17.8	0.129	-138.1	-46.0	0.005	-155.4	0.917	7.3	-1.4
13	0.923	-12.1	-19.3	0.109	-152.2	-40.0	0.010	73.6	0.878	-0.8	-4.5
14	0.922	-20.6	-21.3	0.086	-168.0	-37.1	0.014	33.1	0.883	-7.3	-6.6
15	0.925	-23.6	-21.3	0.086	177.1	-39.2	0.011	-0.7	0.865	-19.0	-7.1
16	0.925	-23.1	-21.1	0.088	166.0	-37.1	0.014	-7.2	0.865	-26.0	-6.9
17	0.924	-24.3	-19.1	0.111	154.3	-43.1	0.007	-179.9	0.857	-33.4	-4.9
18	0.924	-32.5	-17.0	0.141	134.0	-35.4	0.017	159.5	0.837	-42.2	-3.0

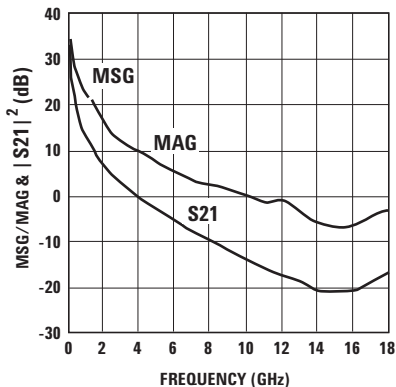

Notes:

1. S parameter is measured on a microstrip line made on 0.025 inch thick alumina carrier. The input reference plane is at the end of the gate lead. The output reference plane is at the end of the drain lead.

Figure 32. MSG/MAG & $|S_{21}|^2$ vs Frequency at 4.5V/200 mA.

ATF-50189 Typical Scattering Parameters at 25°C, $V_{DS} = 4.5V$, $I_{DS} = 360\text{ mA}$

Freq. GHz	S_{11}			S_{21}			S_{12}			S_{22}		MSG/MAG dB
	Mag.	Ang.	dB	Mag.	Ang.	dB	Mag.	Ang.	Mag.	Ang.		
0.1	0.935	-134.4	29.1	28.363	110.9	-39.2	0.011	33.4	0.800	-171.2	34.1	
0.2	0.932	-159.5	23.6	15.134	97.3	-37.7	0.013	28.3	0.838	-177.3	30.7	
0.3	0.932	-170.1	20.2	10.222	90.8	-37.1	0.014	29.1	0.847	179.4	28.6	
0.4	0.930	-176.6	17.7	7.696	86.2	-36.5	0.015	30.9	0.849	176.9	27.1	
0.5	0.930	178.1	15.7	6.096	85.2	-35.9	0.016	35.4	0.854	174.0	25.8	
0.6	0.931	174.2	14.2	5.107	82.8	-35.4	0.017	37.8	0.855	172.0	24.8	
0.7	0.933	170.6	12.9	4.429	80.4	-34.4	0.019	39.7	0.855	170.0	23.7	
0.8	0.933	167.2	11.9	3.919	77.9	-33.6	0.021	40.8	0.853	168.2	22.7	
0.9	0.935	163.9	10.9	3.526	75.3	-33.2	0.022	41.5	0.858	166.3	22.0	
1	0.936	160.7	10.1	3.2	72.6	-32.4	0.024	41.6	0.855	164.4	21.2	
1.1	0.937	159.3	9.7	3.063	71.3	-32.0	0.025	41.5	0.855	163.4	20.9	
1.2	0.938	157.8	9.3	2.925	69.9	-31.7	0.026	41.3	0.855	162.4	20.5	
1.3	0.936	155.1	8.6	2.685	67.2	-31.1	0.028	40.8	0.852	160.7	19.8	
1.4	0.933	152.3	7.9	2.488	64.4	-30.8	0.029	40.0	0.857	158.9	19.3	
1.5	0.933	151.1	7.6	2.401	63.2	-30.5	0.03	39.7	0.857	158.0	19.0	
1.6	0.932	149.8	7.3	2.314	61.9	-30.2	0.031	39.3	0.856	157.0	18.7	
1.7	0.934	147.2	6.7	2.163	59.1	-29.6	0.033	38.2	0.854	155.2	18.1	
1.8	0.934	144.3	6.2	2.032	56.4	-29.4	0.034	37.0	0.855	153.4	17.1	
1.9	0.933	141.7	5.6	1.906	53.9	-28.9	0.036	35.8	0.854	151.8	16.4	
2	0.932	139.3	5.1	1.794	51.3	-28.6	0.037	34.5	0.853	150.0	15.8	
2.1	0.933	136.7	4.6	1.69	48.8	-28.4	0.038	33.2	0.851	148.4	15.2	
2.2	0.930	134.2	4.1	1.6	46.4	-28.0	0.04	31.8	0.852	146.6	14.6	
2.3	0.931	131.6	3.7	1.523	44.0	-27.7	0.041	30.5	0.851	145.0	14.2	
2.4	0.929	129.2	3.2	1.442	41.7	-27.5	0.042	29.0	0.853	143.3	13.7	
2.5	0.924	126.7	2.7	1.371	39.2	-27.1	0.044	27.5	0.845	142.1	13.0	
3	0.917	114.6	0.7	1.09	27.7	-26.4	0.048	20.1	0.855	134.5	11.1	
3.5	0.911	102.2	-1.1	0.886	18.3	-25.7	0.052	13.6	0.874	129.8	9.6	
4	0.921	93.1	-2.3	0.771	9.1	-25.5	0.053	6.8	0.894	121.3	9.1	
5	0.922	79.3	-4.9	0.569	-10.0	-24.9	0.057	-7.3	0.912	101.1	7.2	
6	0.921	64.3	-7.1	0.441	-30.0	-24.6	0.059	-28.5	0.929	85.8	6.3	
7	0.921	43.0	-9.4	0.337	-46.5	-25.8	0.051	-40.6	0.863	68.4	2.8	
8	0.922	25.9	-11.3	0.273	-65.6	-26.6	0.047	-57.3	0.875	53.0	1.6	
9	0.922	13.2	-13.0	0.225	-84.2	-28.2	0.039	-76.1	0.914	35.5	1.5	
10	0.921	11.7	-15.3	0.171	-93.0	-31.1	0.028	-84.5	0.935	26.0	0.7	
11	0.921	0.8	-16.2	0.155	-106.9	-33.6	0.021	-111.9	0.899	19.0	-1.2	
12	0.923	-7.6	-17.1	0.139	-117.3	-43.1	0.007	-160.6	0.954	7.2	1.7	
13	0.923	-10.9	-18.3	0.122	-130.6	-39.2	0.011	77.1	0.901	-1.6	-2.4	
14	0.922	-20.2	-19.2	0.11	-150.3	-36.5	0.015	31.3	0.897	-8.1	-3.8	
15	0.925	-23.6	-19.0	0.112	-172.7	-37.7	0.013	-5.0	0.884	-20.3	-4.2	
16	0.924	-21.8	-19.4	0.107	165.1	-39.2	0.011	-3.4	0.873	-27.6	-5.0	
17	0.924	-24.0	-18.1	0.124	147.9	-39.2	0.011	-175.1	0.865	-35.4	-3.6	
18	0.923	-31.6	-17.3	0.136	127.1	-33.2	0.022	153.4	0.830	-43.4	-3.5	

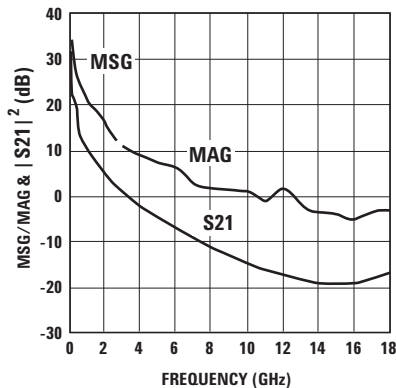

Notes:

1. S parameter is measured on a microstrip line made on 0.025 inch thick alumina carrier. The input reference plane is at the end of the gate lead. The output reference plane is at the end of the drain lead.

Figure 33. MSG/MAG & $|S_{21}|^2$ vs Frequency at 4.5V/360 mA.

ATF-50189 Typical Scattering Parameters at 25°C, $V_{DS} = 5.5V$, $I_{DS} = 280\text{ mA}$

Freq. GHz	S_{11}			S_{21}			S_{12}			S_{22}		MSG/MAG dB
	Mag.	Ang.	dB	Mag.	Ang.	dB	Mag.	Ang.	dB	Mag.	Ang.	
0.1	0.921	-132.3	31.4	36.968	111.4	-37.7	0.013	31.1	0.651	-160.8	34.5	
0.2	0.916	-158.2	26.0	19.86	97.3	-36.5	0.015	23.9	0.698	-171.7	31.2	
0.3	0.917	-169.1	22.6	13.453	90.5	-36.5	0.015	23.3	0.709	-176.6	29.5	
0.4	0.915	-175.9	20.1	10.143	85.6	-35.9	0.016	24.4	0.712	-179.8	28.0	
0.5	0.913	178.7	18.1	8.037	84.1	-35.4	0.017	28.1	0.716	176.2	26.7	
0.6	0.914	174.5	16.6	6.733	81.3	-34.9	0.018	30.2	0.715	173.8	25.7	
0.7	0.916	170.9	15.3	5.837	78.6	-34.4	0.019	32.0	0.715	171.6	24.9	
0.8	0.916	167.4	14.3	5.163	75.8	-33.6	0.021	33.2	0.713	169.6	23.9	
0.9	0.918	164.1	13.3	4.632	72.9	-33.2	0.022	34.1	0.714	167.6	23.2	
1	0.919	160.8	12.5	4.205	70.0	-32.8	0.023	34.4	0.712	165.7	22.6	
1.1	0.920	159.4	12.1	4.024	68.5	-32.4	0.024	34.4	0.712	164.8	22.2	
1.2	0.921	157.9	11.7	3.842	67.0	-32.0	0.025	34.4	0.712	163.8	21.9	
1.3	0.920	155.2	10.9	3.525	64.0	-31.7	0.026	34.2	0.711	162.0	21.3	
1.4	0.917	152.3	10.3	3.261	61.0	-31.4	0.027	33.8	0.713	160.2	20.4	
1.5	0.917	149.8	9.6	3.031	58.3	-30.8	0.029	33.4	0.713	158.4	19.5	
1.6	0.920	147.2	9.0	2.832	55.3	-30.5	0.030	32.7	0.713	156.6	18.9	
1.7	0.920	144.3	8.5	2.656	52.3	-30.2	0.031	31.8	0.713	154.8	18.1	
1.8	0.919	141.7	7.9	2.490	49.6	-29.6	0.033	31.1	0.714	153.2	17.4	
1.9	0.918	139.2	7.4	2.342	46.8	-29.4	0.034	30.0	0.714	151.6	16.8	
2	0.919	136.7	6.9	2.206	44.1	-29.1	0.035	29.0	0.714	150.0	16.3	
2.1	0.917	134.1	6.4	2.089	41.4	-28.9	0.036	27.8	0.715	148.2	15.7	
2.2	0.919	131.5	5.9	1.982	38.6	-28.6	0.037	26.8	0.715	146.6	15.3	
2.3	0.916	129.3	5.4	1.870	35.8	-28.4	0.038	25.4	0.714	144.8	14.7	
2.4	0.912	126.6	5.0	1.784	33.4	-28.2	0.039	24.3	0.715	143.8	14.1	
2.5	0.909	124.5	4.6	1.707	31.0	-28.0	0.040	23.3	0.732	142.1	13.7	
3	0.909	112.2	2.6	1.345	18.4	-27.1	0.044	16.9	0.734	135.3	11.7	
3.5	0.912	99.5	0.8	1.091	8.3	-26.6	0.047	11.5	0.742	131.4	10.2	
4	0.923	92.6	-0.5	0.944	-2.0	-26.3	0.048	6.2	0.752	122.9	9.5	
5	0.922	78.2	-3.4	0.678	-23.9	-25.7	0.052	-5.8	0.771	102.2	7.0	
6	0.921	61.3	-5.8	0.514	-46.3	-26.2	0.049	-22.8	0.791	84.0	5.2	
7	0.921	41.2	-8.3	0.383	-64.8	-26.6	0.047	-39.7	0.802	69.1	3.1	
8	0.922	24.3	-10.5	0.298	-85.4	-27.3	0.043	-55.8	0.841	54.0	2.0	
9	0.923	11.8	-12.8	0.230	-106.2	-29.1	0.035	-73.3	0.883	36.5	1.2	
10	0.922	10.8	-14.9	0.179	-114.3	-31.7	0.026	-81.6	0.900	27.0	0	
11	0.921	0.3	-16.4	0.151	-132.9	-35.4	0.017	-112	0.879	20.6	-1.8	
12	0.924	-8.0	-18.3	0.121	-145.5	-48.0	0.004	-174.6	0.924	8.0	-1.5	
13	0.923	-12.1	-20.1	0.099	-162.1	-37.7	0.013	75.2	0.885	0.6	-5.1	
14	0.922	-20.6	-22.2	0.078	-177.8	-35.9	0.016	38.6	0.889	-5.1	-7.2	
15	0.925	-23.6	-22.9	0.072	168.0	-38.4	0.012	11.1	0.872	-15.9	-8.4	
16	0.925	-23.1	-22.9	0.072	158.3	-37.1	0.014	5.1	0.873	-21.8	-8.4	
17	0.924	-24.3	-20.4	0.096	150.1	-43.1	0.007	155.8	0.867	-27.8	-5.8	
18	0.924	-32.5	-18.1	0.125	133.1	-36.5	0.015	146.2	0.855	-34.7	-3.7	

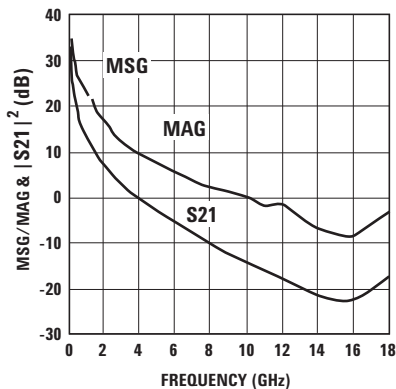

Notes:

1. S parameter is measured on a microstrip line made on 0.025 inch thick alumina carrier. The input reference plane is at the end of the gate lead. The output reference plane is at the end of the drain lead.

Figure 34. MSG/MAG & $|S_{21}|^2$ vs Frequency at 5.5V/280 mA.

ATF-50189 Typical Scattering Parameters at 25°C, $V_{DS} = 5.5V$, $I_{DS} = 200\text{ mA}$

Freq. GHz	S_{11}			S_{21}			S_{12}			S_{22}		MSG/MAG dB
	Mag.	Ang.	dB	Mag.	Ang.	dB	Mag.	Ang.	Mag.	Ang.		
0.1	0.922	-131.5	31.3	36.764	111.7	-37.1	0.014	30.8	0.65	-159.4	34.2	
0.2	0.917	-157.7	25.9	19.783	97.5	-36.5	0.015	23.2	0.70	-171.0	31.2	
0.3	0.916	-168.8	22.5	13.403	90.6	-35.9	0.016	22.1	0.71	-176.1	29.2	
0.4	0.914	-175.7	20.1	10.105	85.7	-35.4	0.017	22.9	0.71	-179.5	27.7	
0.5	0.912	178.8	18.1	8.007	84.1	-34.9	0.018	26.5	0.72	176.4	26.5	
0.6	0.913	174.7	16.5	6.708	81.3	-34.4	0.019	28.6	0.72	174.1	25.5	
0.7	0.915	171.0	15.3	5.815	78.7	-34.0	0.02	30.3	0.72	171.8	24.6	
0.8	0.916	167.6	14.2	5.144	75.9	-33.6	0.021	31.4	0.71	169.8	23.9	
0.9	0.918	164.1	13.3	4.613	72.9	-33.2	0.022	32.4	0.71	167.7	23.2	
1	0.918	161.0	12.4	4.188	70.1	-32.4	0.024	32.7	0.71	165.9	22.4	
1.1	0.919	159.5	12.1	4.008	68.6	-32.0	0.025	32.8	0.71	164.9	22.0	
1.2	0.920	158.0	11.7	3.827	67.1	-32.0	0.025	32.8	0.71	163.9	21.8	
1.3	0.920	155.3	10.9	3.512	64.0	-31.7	0.026	32.5	0.71	162.1	21.3	
1.4	0.917	152.4	10.2	3.249	61.1	-31.1	0.028	32.2	0.71	160.3	20.6	
1.5	0.917	150.0	9.6	3.023	58.4	-30.8	0.029	31.9	0.71	158.5	19.7	
1.6	0.919	147.3	9.0	2.821	55.3	-30.5	0.03	31.2	0.71	156.7	19.0	
1.7	0.918	144.5	8.5	2.648	52.3	-29.9	0.032	30.4	0.72	154.9	18.3	
1.8	0.919	141.8	7.9	2.482	49.6	-29.6	0.033	29.6	0.72	153.3	17.6	
1.9	0.918	139.3	7.4	2.333	46.8	-29.4	0.034	28.6	0.72	151.6	16.9	
2	0.918	136.7	6.8	2.199	44.1	-29.1	0.035	27.6	0.72	150.0	16.3	
2.1	0.917	134.2	6.4	2.082	41.4	-28.9	0.036	26.5	0.72	148.2	15.8	
2.2	0.918	131.6	5.9	1.973	38.6	-28.6	0.037	25.4	0.72	146.7	15.3	
2.3	0.913	129.4	5.4	1.868	35.7	-28.4	0.038	24.2	0.71	145.1	14.6	
2.4	0.912	126.7	5.0	1.778	33.4	-28.2	0.039	23.0	0.72	143.8	14.1	
2.5	0.908	124.5	4.6	1.700	31.1	-28.0	0.04	22.1	0.73	142.1	13.6	
3	0.907	112.2	2.5	1.340	18.4	-27.1	0.044	15.8	0.74	135.2	11.7	
3.5	0.912	99.5	1.4	1.176	7.8	-26.7	0.046	9.7	0.76	126.6	10.8	
4	0.923	92.6	0.1	1.012	-2.9	-26.6	0.047	3.5	0.78	117.9	10.3	
5	0.922	78.2	-3.3	0.685	-24.1	-26.4	0.048	-10.3	0.82	100.7	7.8	
6	0.921	61.3	-5.8	0.512	-46.3	-26.6	0.047	-25.6	0.85	84.1	6.2	
7	0.921	41.2	-8.4	0.381	-64.7	-26.7	0.046	-40.9	0.86	67.8	4.0	
8	0.922	24.3	-10.5	0.298	-85.4	-27.3	0.043	-56.4	0.87	51.5	2.5	
9	0.923	11.8	-12.8	0.230	-106.7	-29.1	0.035	-74.0	0.88	36.5	1.2	
10	0.922	10.8	-14.9	0.179	-114.6	-31.7	0.026	-82.1	0.90	27.1	0	
11	0.921	0.3	-16.4	0.151	-132.2	-35.4	0.017	-113.8	0.88	20.7	-1.8	
12	0.924	-8.0	-18.4	0.120	-145.0	-46.0	0.005	179.4	0.92	8.1	-1.8	
13	0.923	-12.1	-20.1	0.099	-161.7	-37.7	0.013	76.2	0.89	0.7	-4.9	
14	0.922	-20.6	-22.2	0.078	-176.9	-35.9	0.016	39.1	0.89	-5.0	-7.2	
15	0.925	-23.6	-22.9	0.072	171.6	-38.4	0.012	12.7	0.87	-15.8	-8.4	
16	0.925	-23.1	-22.4	0.076	160.6	-36.5	0.015	6.4	0.87	-21.7	-8.0	
17	0.924	-24.3	-20.1	0.099	151.7	-43.1	0.007	153.6	0.87	-27.7	-5.5	
18	0.924	-32.5	-18.1	0.125	131.4	-36.5	0.015	145.0	0.86	-34.6	-3.5	

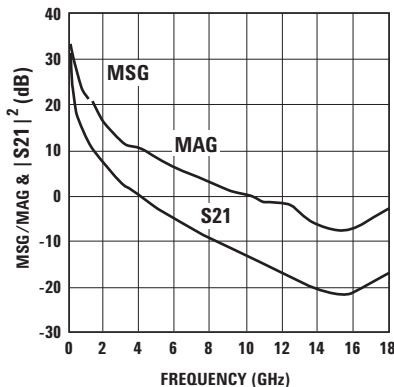

Notes:

1. S parameter is measured on a microstrip line made on 0.025 inch thick alumina carrier. The input reference plane is at the end of the gate lead. The output reference plane is at the end of the drain lead.

Figure 35. MSG/MAG & $|S_{21}|^2$ vs Frequency at 5.5V/200 mA.

ATF-50189 Typical Scattering Parameters at 25°C, $V_{DS} = 5.5V$, $I_{DS} = 360\text{ mA}$

Freq. GHz	S_{11}			S_{21}			S_{12}			S_{22}		MSG/MAG dB
	Mag.	Ang.	dB	Mag.	Ang.	dB	Mag.	Ang.	Mag.	Ang.		
0.1	0.874	-133.9	31.3	36.688	112.8	-39.2	0.011	32.1	0.639	-161.7	35.2	
0.2	0.902	-159.0	26.0	19.973	98.3	-37.7	0.013	25.5	0.688	-172	31.9	
0.3	0.910	-169.6	22.7	13.575	91.1	-37.1	0.014	24.9	0.699	-176.7	29.9	
0.4	0.911	-176.2	20.2	10.251	86.1	-36.5	0.015	26.2	0.702	-179.9	28.3	
0.5	0.911	178.4	18.2	8.123	84.4	-35.9	0.016	30.0	0.706	176.1	27.1	
0.6	0.912	174.4	16.7	6.810	81.6	-35.4	0.017	32.1	0.706	173.7	26.0	
0.7	0.914	170.8	15.4	5.902	78.8	-34.9	0.018	34.0	0.705	171.5	25.2	
0.8	0.916	167.4	14.4	5.218	76.0	-34.4	0.019	35.3	0.702	169.6	24.4	
0.9	0.916	164.0	13.4	4.686	73.0	-33.6	0.021	36.2	0.705	167.6	23.5	
1	0.917	160.9	12.6	4.247	70.1	-33.2	0.022	36.6	0.702	165.7	22.9	
1.1	0.919	159.5	12.2	4.064	68.6	-33.0	0.0225	36.6	0.702	164.7	22.6	
1.2	0.920	158.0	11.8	3.881	67.1	-32.8	0.023	36.5	0.702	163.7	22.3	
1.3	0.919	155.3	11.0	3.562	64.1	-32.0	0.025	36.3	0.700	162.1	21.2	
1.4	0.915	152.4	10.4	3.296	61.0	-31.7	0.026	35.8	0.703	160.3	19.7	
1.5	0.916	150.0	9.7	3.064	58.3	-31.4	0.027	35.5	0.702	158.5	19.0	
1.6	0.918	147.4	9.1	2.861	55.2	-30.8	0.029	34.8	0.702	156.7	18.5	
1.7	0.918	144.5	8.6	2.684	52.2	-30.5	0.03	33.9	0.702	155.0	17.9	
1.8	0.918	141.9	8.0	2.517	49.5	-30.2	0.031	33.0	0.703	153.4	17.3	
1.9	0.917	139.4	7.5	2.368	46.7	-29.6	0.033	32.0	0.703	151.8	16.7	
2	0.918	136.9	7.0	2.229	43.9	-29.4	0.034	30.9	0.703	150.2	16.2	
2.1	0.916	134.4	6.5	2.110	41.2	-29.1	0.035	29.7	0.705	148.5	15.6	
2.2	0.917	131.8	6.0	2.003	38.4	-28.9	0.036	28.6	0.704	146.9	15.2	
2.3	0.913	129.6	5.5	1.89	35.6	-28.6	0.037	27.3	0.702	145.6	14.5	
2.4	0.911	126.9	5.1	1.802	33.2	-28.4	0.038	26.1	0.703	144.2	14.0	
2.5	0.907	124.8	4.7	1.724	30.8	-28.2	0.039	25.1	0.722	142.6	13.6	
3	0.907	112.5	2.7	1.360	18.0	-27.3	0.043	18.7	0.724	135.9	11.7	
3.5	0.912	99.5	1.5	1.192	7.1	-26.9	0.045	11.0	0.742	127.8	10.8	
4	0.923	92.6	0.5	1.054	-3.7	-26.6	0.047	3.0	0.761	118.9	10.5	
5	0.922	78.2	-2.2	0.777	-25.4	-26.2	0.049	-11.9	0.799	101.3	8.6	
6	0.921	61.3	-5.7	0.520	-47.3	-26.6	0.047	-25.5	0.828	84.3	5.9	
7	0.921	41.2	-8.2	0.388	-66.0	-26.7	0.046	-39.2	0.846	68.3	3.9	
8	0.922	24.3	-10.3	0.304	-86.5	-27.3	0.043	-54.0	0.863	52.3	2.5	
9	0.923	11.8	-12.7	0.233	-108.9	-29.1	0.035	-71.3	0.877	37.6	1.2	
10	0.922	10.8	-14.8	0.181	-117.8	-31.7	0.026	-78.2	0.894	28.0	-0.2	
11	0.921	0.3	-16.1	0.156	-134.7	-34.9	0.018	-106.9	0.874	21.3	-1.7	
12	0.924	-8.0	-18.1	0.125	-147.8	-48.0	0.004	-144.3	0.919	8.2	-1.6	
13	0.923	-12.1	-19.7	0.104	-165.7	-40.0	0.01	74.2	0.878	0.1	-4.9	
14	0.922	-20.6	-21.9	0.080	178.6	-37.1	0.014	30.8	0.881	-6.4	-7.3	
15	0.925	-23.6	-22.3	0.077	167.6	-40.0	0.01	-3.8	0.864	-17.9	-8.0	
16	0.925	-23.1	-22.3	0.077	155.5	-38.4	0.012	-13.4	0.861	-25.0	-8.2	
17	0.924	-24.3	-19.5	0.106	148.1	-39.2	0.011	-177.4	0.854	-32.2	-5.3	
18	0.924	-32.5	-17.6	0.132	130.3	-33.6	0.021	165.0	0.832	-41.4	-3.7	

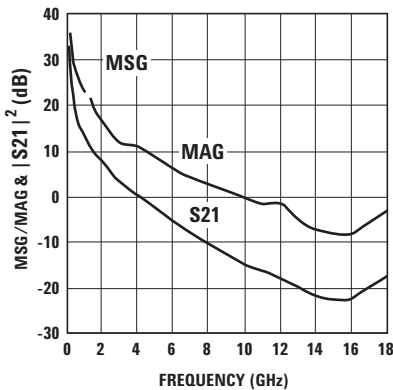

Notes:

1. S parameter is measured on a microstrip line made on 0.025 inch thick alumina carrier. The input reference plane is at the end of the gate lead. The output reference plane is at the end of the drain lead.

Figure 36. MSG/MAG & $|S_{21}|^2$ vs Frequency at 5.5V/360 mA.

ATF-50189 Typical Scattering Parameters at 25°C, $V_{DS} = 3.5V$, $I_{DS} = 280\text{ mA}$

Freq. GHz	S_{11}		dB	S_{21}		dB	S_{12}		S_{22}		MSG/MAG dB
	Mag.	Ang.		Mag.	Ang.		Mag.	Ang.	Mag.	Ang.	
0.1	0.926	-134.5	29.5	29.964	111.1	-39.2	0.011	33.1	0.776	-169.9	34.4
0.2	0.928	-159.6	24.1	16.031	97.4	-37.7	0.013	27.4	0.817	-176.6	30.9
0.3	0.930	-170.1	20.7	10.841	90.8	-37.1	0.014	27.5	0.826	179.8	28.9
0.4	0.928	-176.7	18.2	8.172	86.1	-36.5	0.015	29.0	0.829	177.1	27.4
0.5	0.927	178.0	16.2	6.472	84.9	-35.9	0.016	33.4	0.834	174.0	26.1
0.6	0.929	174.0	14.7	5.424	82.4	-35.4	0.017	35.7	0.835	171.9	25.0
0.7	0.930	170.4	13.4	4.704	80.0	-34.4	0.019	37.6	0.835	169.9	23.9
0.8	0.932	167.0	12.4	4.161	77.4	-34.0	0.02	38.8	0.833	168.0	23.2
0.9	0.933	163.6	11.5	3.744	74.7	-33.2	0.022	39.6	0.838	166.1	22.3
1	0.934	160.4	10.6	3.397	72.0	-32.4	0.024	39.7	0.836	164.1	21.5
1.1	0.935	159.0	10.2	3.250	70.6	-32.0	0.025	39.6	0.836	163.1	21.1
1.2	0.936	157.5	9.8	3.103	69.2	-32.0	0.025	39.5	0.835	162.1	20.9
1.3	0.935	154.7	9.1	2.848	66.4	-31.4	0.027	39.0	0.832	160.3	20.2
1.4	0.932	151.9	8.4	2.637	63.5	-31.1	0.028	38.2	0.837	158.4	19.7
1.5	0.931	149.4	7.8	2.453	60.9	-30.5	0.03	37.6	0.836	156.5	19.0
1.6	0.933	146.8	7.2	2.292	58.1	-30.2	0.031	36.6	0.834	154.6	18.1
1.7	0.931	143.9	6.7	2.153	55.4	-29.6	0.033	35.5	0.835	152.8	17.3
1.8	0.933	141.2	6.1	2.018	52.8	-29.4	0.034	34.4	0.835	151.1	16.8
1.9	0.931	138.7	5.6	1.899	50.1	-28.9	0.036	33.0	0.834	149.4	16.1
2	0.931	136.2	5.0	1.788	47.5	-28.6	0.037	31.7	0.833	147.7	15.5
2.1	0.929	133.6	4.6	1.691	45.1	-28.4	0.038	30.3	0.834	145.9	14.9
2.2	0.930	131.0	4.1	1.609	42.5	-28.0	0.040	29.0	0.833	144.2	14.5
2.3	0.927	128.7	3.7	1.526	40.1	-27.7	0.041	27.3	0.827	142.4	13.9
2.4	0.923	126.2	3.2	1.447	37.6	-27.5	0.042	26.1	0.827	141.2	13.3
2.5	0.920	124.0	2.8	1.386	35.6	-27.3	0.043	25.0	0.848	139.6	13.1
3	0.918	111.6	0.8	1.095	23.8	-26.6	0.047	17.5	0.841	132.4	11.1
3.5	0.912	99.5	-1.0	0.891	14.7	-26.0	0.050	11.3	0.837	128.1	9.2
4	0.923	92.6	-2.3	0.770	6.7	-25.7	0.052	6.4	0.838	121.4	8.5
5	0.922	78.2	-5.0	0.565	-14.8	-25.5	0.053	-8.4	0.840	98.7	6.2
6	0.921	61.3	-7.1	0.442	-35.0	-25.4	0.054	-29.5	0.853	80.1	4.6
7	0.921	41.2	-9.5	0.336	-51.9	-26.4	0.048	-42.3	0.857	65.5	2.7
8	0.922	24.3	-11.3	0.271	-70.9	-27.1	0.044	-58.9	0.881	50.5	1.8
9	0.923	11.8	-13.4	0.215	-90.6	-29.1	0.035	-77	0.916	33.6	1.5
10	0.922	10.8	-15.3	0.171	-98.1	-32.0	0.025	-86.1	0.925	24.4	0.4
11	0.921	0.3	-16.4	0.151	-113.4	-35.9	0.016	-119.4	0.899	18.3	-1.2
12	0.924	-8.0	-17.9	0.127	-124.8	-46.0	0.005	166.3	0.943	5.9	0.2
13	0.923	-12.1	-19.2	0.11	-139.7	-37.1	0.014	75.0	0.900	-1.3	-3.4
14	0.922	-20.6	-20.6	0.093	-156.5	-35.4	0.017	37.4	0.903	-6.9	-5.0
15	0.925	-23.6	-20.4	0.095	-175.6	-38.4	0.012	5.2	0.885	-17.6	-5.6
16	0.925	-23.1	-20.4	0.096	168.4	-37.7	0.013	-2.2	0.881	-23.9	-5.7
17	0.924	-24.3	-18.3	0.121	151.1	-40.0	0.01	166.0	0.870	-30.0	-3.6
18	0.924	-32.5	-16.7	0.146	128.4	-33.6	0.021	145.9	0.846	-37.2	-2.4

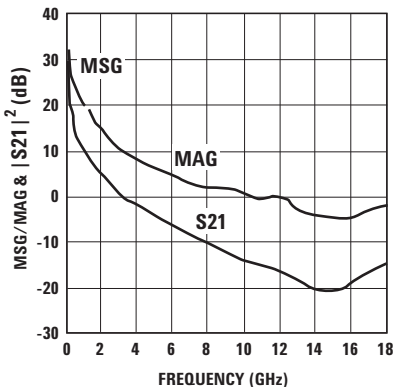

Notes:

1. S parameter is measured on a microstrip line made on 0.025 inch thick alumina carrier. The input reference plane is at the end of the gate lead. The output reference plane is at the end of the drain lead.

Figure 37. MSG/MAG & $|S_{21}|^2$ vs Frequency at 3.5V/280 mA.

ATF-50189 Typical Scattering Parameters at 25°C, $V_{DS} = 3.5V$, $I_{DS} = 200\text{ mA}$

Freq. GHz	S_{11}			S_{21}			S_{12}			S_{22}		MSG/MAG dB
	Mag.	Ang.	dB	Mag.	Ang.	dB	Mag.	Ang.	dB	Mag.	Ang.	
0.1	0.927	-132.6	30.4	33.278	111.3	-37.1	0.014	30.8	0.713	-163.4	33.8	
0.2	0.922	-158.4	25.0	17.839	97.4	-35.9	0.016	23.7	0.762	-173.1	30.5	
0.3	0.921	-169.2	21.6	12.071	90.7	-35.4	0.017	23.1	0.773	-177.6	28.5	
0.4	0.919	-176.0	19.2	9.101	86.0	-34.9	0.018	24.1	0.776	179.3	27.0	
0.5	0.918	178.6	17.2	7.208	84.6	-34.9	0.018	28.0	0.780	175.7	26.0	
0.6	0.919	174.6	15.6	6.036	82.0	-34.4	0.019	30.1	0.779	173.5	25.0	
0.7	0.919	171.0	14.4	5.237	79.5	-33.6	0.021	32.0	0.780	171.4	24.0	
0.8	0.920	167.6	13.3	4.637	76.9	-33.2	0.022	33.1	0.778	169.4	23.2	
0.9	0.922	164.2	12.4	4.159	74.1	-32.4	0.024	34.0	0.779	167.4	22.4	
1	0.923	161.1	11.5	3.778	71.4	-32.0	0.025	34.4	0.778	165.6	21.8	
1.1	0.924	159.7	11.2	3.617	70.0	-31.7	0.026	34.4	0.779	164.7	21.4	
1.2	0.924	158.2	10.8	3.455	68.5	-31.4	0.027	34.4	0.779	163.7	21.1	
1.3	0.924	155.5	10.0	3.171	65.6	-31.1	0.028	34.1	0.778	161.9	20.5	
1.4	0.921	152.6	9.4	2.936	62.8	-30.5	0.030	33.6	0.779	160.0	19.9	
1.5	0.920	150.2	8.7	2.734	60.1	-30.2	0.031	33.3	0.779	158.2	19.5	
1.6	0.923	147.6	8.1	2.554	57.2	-29.9	0.032	32.5	0.778	156.5	19.0	
1.7	0.922	144.7	7.6	2.395	54.4	-29.4	0.034	31.7	0.779	154.6	18.1	
1.8	0.922	142.1	7.0	2.248	51.8	-29.1	0.035	30.8	0.778	153.1	17.2	
1.9	0.921	139.6	6.5	2.116	49.2	-28.9	0.036	29.7	0.778	151.4	16.5	
2	0.921	137.1	6.0	1.994	46.5	-28.4	0.038	28.7	0.777	149.7	15.9	
2.1	0.919	134.6	5.5	1.889	44.0	-28.2	0.039	27.4	0.778	148.0	15.3	
2.2	0.920	132.0	5.1	1.792	41.3	-28.0	0.040	26.3	0.777	146.4	14.8	
2.3	0.918	129.7	4.6	1.690	38.8	-27.7	0.041	25.1	0.777	145.1	14.3	
2.4	0.914	127.1	4.2	1.618	36.4	-27.5	0.042	23.8	0.775	143.5	13.7	
2.5	0.910	125.0	3.8	1.549	34.1	-27.3	0.043	22.8	0.792	141.8	13.3	
3	0.909	112.7	1.8	1.226	22.1	-26.6	0.047	16.3	0.790	135.0	11.3	
3.5	0.912	99.5	0.0	1.000	12.5	-26.0	0.050	10.7	0.796	131.2	9.8	
4	0.923	92.6	-1.2	0.869	2.9	-25.7	0.052	5.2	0.801	122.7	9.1	
5	0.922	78.2	-4.0	0.633	-18.0	-25.0	0.056	-7.1	0.812	102.1	6.7	
6	0.921	61.3	-6.2	0.488	-39.4	-25.5	0.053	-24.3	0.823	84.0	5.0	
7	0.921	41.2	-8.7	0.369	-57.1	-26.0	0.050	-41.5	0.822	69.2	2.9	
8	0.922	24.3	-10.6	0.294	-76.8	-26.7	0.046	-58.0	0.854	53.9	1.9	
9	0.923	11.8	-12.8	0.230	-97.3	-28.4	0.038	-75.9	0.890	36.3	1.2	
10	0.922	10.8	-15.1	0.176	-105.0	-31.1	0.028	-84.6	0.901	26.6	-0.3	
11	0.921	0.3	-16.1	0.156	-120.3	-34.4	0.019	-113.3	0.877	19.8	-1.7	
12	0.924	-8.0	-17.9	0.128	-132.2	-44.4	0.006	-164.6	0.921	6.7	-1.2	
13	0.923	-12.1	-19.2	0.110	-146.9	-39.2	0.011	75.2	0.881	-1.4	-4.2	
14	0.922	-20.6	-20.8	0.091	-161.8	-36.5	0.015	34.4	0.885	-7.8	-6.0	
15	0.925	-23.6	-20.8	0.091	-177.7	-38.4	0.012	-0.7	0.868	-19.5	-6.5	
16	0.925	-23.1	-20.6	0.093	168.1	-37.7	0.013	-7.2	0.867	-26.6	-6.4	
17	0.924	-24.3	-18.4	0.120	156.0	-41.9	0.008	-177.4	0.857	-34.0	-4.2	
18	0.924	-32.5	-16.5	0.150	132.5	-34.9	0.018	158.2	0.833	-42.9	-2.5	

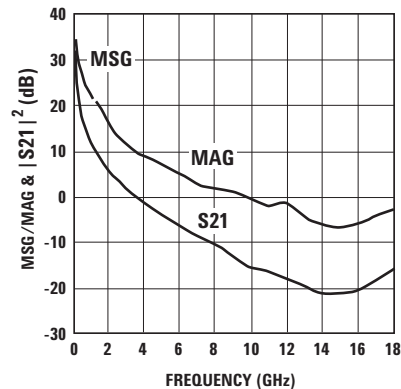

Notes:

1. S parameter is measured on a microstrip line made on 0.025 inch thick alumina carrier. The input reference plane is at the end of the gate lead. The output reference plane is at the end of the drain lead.

Figure 38. MSG/MAG & $|S_{21}|^2$ vs Frequency at 3.5V/200 mA.

ATF-50189 Typical Scattering Parameters at 25°C, $V_{DS} = 3.5V$, $I_{DS} = 360\text{ mA}$

Freq. GHz	S_{11}			S_{21}			S_{12}			S_{22}		MSG/MAG dB
	Mag.	Ang.	dB	Mag.	Ang.	dB	Mag.	Ang.	Mag.	Ang.		
0.1	0.925	-134.2	30.4	33.142	110.8	-38.4	0.012	31.9	0.73	-166.7	34.4	
0.2	0.923	-159.4	25.0	17.732	97.1	-37.1	0.014	25.7	0.77	-174.9	31.0	
0.3	0.924	-170.0	21.6	11.996	90.5	-36.5	0.015	25.7	0.78	-179.0	29.0	
0.4	0.923	-176.6	19.1	9.042	85.8	-35.9	0.016	27.1	0.79	-178.1	27.5	
0.5	0.922	178.1	17.1	7.165	84.5	-35.9	0.016	31.4	0.79	-174.8	26.5	
0.6	0.923	174.1	15.6	6.003	81.9	-34.9	0.018	33.6	0.79	-172.6	25.2	
0.7	0.924	170.5	14.3	5.206	79.4	-34.4	0.019	35.5	0.79	-170.5	24.4	
0.8	0.925	167.1	13.3	4.608	76.8	-34.0	0.02	36.6	0.79	-168.5	23.6	
0.9	0.927	163.6	12.3	4.138	74.0	-33.2	0.022	37.5	0.79	-166.5	22.7	
1	0.928	160.5	11.5	3.757	71.2	-32.4	0.024	37.7	0.79	-164.6	21.9	
1.1	0.929	159.1	11.1	3.596	69.8	-32.0	0.025	37.7	0.79	-163.6	21.6	
1.2	0.929	157.6	10.7	3.435	68.3	-32.0	0.025	37.6	0.79	-162.6	21.4	
1.3	0.929	154.8	10.0	3.152	65.4	-31.7	0.026	37.1	0.79	-160.8	20.8	
1.4	0.925	152.0	9.3	2.918	62.5	-31.1	0.028	36.6	0.79	-158.9	20.2	
1.5	0.926	149.5	8.7	2.713	59.9	-30.8	0.029	36.1	0.79	-157.1	19.1	
1.6	0.927	146.8	8.1	2.535	57.0	-30.2	0.031	35.1	0.79	-155.3	18.5	
1.7	0.927	144.1	7.5	2.380	54.1	-29.9	0.032	34.1	0.79	-153.4	17.8	
1.8	0.927	141.3	7.0	2.231	51.5	-29.4	0.034	33.0	0.79	-151.8	17.1	
1.9	0.926	138.9	6.4	2.098	48.8	-29.1	0.035	31.8	0.79	-150.0	16.5	
2	0.926	136.4	5.9	1.977	46.2	-28.9	0.036	30.6	0.79	-148.4	15.9	
2.1	0.923	133.8	5.4	1.871	43.6	-28.6	0.037	29.3	0.79	-146.6	15.3	
2.2	0.926	131.2	5.0	1.777	41.0	-28.2	0.039	28.1	0.79	-144.9	14.9	
2.3	0.922	128.8	4.5	1.684	38.6	-28.0	0.04	26.6	0.79	-143.5	14.3	
2.4	0.919	126.3	4.1	1.600	36.0	-27.7	0.041	25.3	0.79	-142.0	13.8	
2.5	0.915	124.2	3.7	1.531	33.8	-27.5	0.042	24.2	0.80	-140.3	13.3	
3	0.913	111.9	1.6	1.208	21.7	-26.7	0.046	17.2	0.80	-133.2	11.3	
3.5	0.912	99.5	-0.2	0.982	12.2	-26.6	0.047	10.0	0.80	-124.8	9.6	
4	0.923	92.6	-1.5	0.846	3.8	-26.4	0.048	2.8	0.81	-116.4	9.0	
5	0.922	78.2	-4.2	0.618	-18.4	-26.0	0.05	-11.7	0.82	-99.5	6.8	
6	0.921	61.3	-6.4	0.477	-39.3	-25.7	0.052	-26.1	0.83	-82.7	5.0	
7	0.921	41.2	-8.9	0.360	-56.8	-26.0	0.05	-39.4	0.83	-66.6	2.8	
8	0.922	24.3	-10.9	0.286	-76.6	-26.7	0.046	-55.9	0.86	-51.6	1.8	
9	0.923	11.8	-12.9	0.226	-97.3	-28.4	0.038	-73.5	0.90	-34.5	1.3	
10	0.922	10.8	-15.0	0.177	-104.9	-31.1	0.028	-81.6	0.91	-25.1	0	
11	0.921	0.3	-16.4	0.152	-121.3	-34.4	0.019	-108.3	0.89	-18.9	-1.6	
12	0.924	-8.0	-18.1	0.124	-134.4	-46.0	0.005	-147.3	0.93	-6.5	-1.0	
13	0.923	-12.1	-19.6	0.105	-148.8	-40.0	0.01	-71.0	0.89	-0.7	-4.4	
14	0.922	-20.6	-21.2	0.087	-163.5	-37.1	0.014	-30.2	0.89	-6.3	-6.2	
15	0.925	-23.6	-21.4	0.085	-178.8	-39.2	0.011	-4.9	0.88	-17.1	-6.7	
16	0.925	-23.1	-21.2	0.087	167.6	-37.7	0.013	-8.8	0.87	-23.1	-6.9	
17	0.924	-24.3	-18.6	0.117	155.7	-41.9	0.008	-173.5	0.87	-29.2	-4.0	
18	0.924	-32.5	-16.8	0.145	133.2	-35.4	0.017	161.7	0.85	-36.3	-2.4	

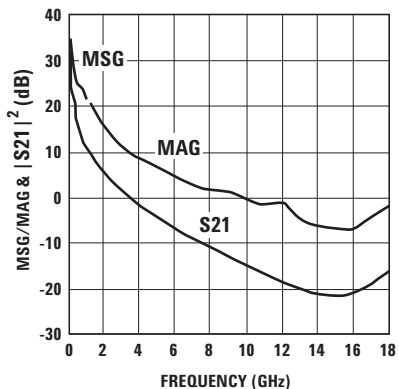

Notes:

1. S parameter is measured on a microstrip line made on 0.025 inch thick alumina carrier. The input reference plane is at the end of the gate lead. The output reference plane is at the end of the drain lead.

Figure 39. MSG/MAG & $|S_{21}|^2$ vs Frequency at 3.5V/360 mA.

Device Models, PCB Layout and Stencil Device

Refer to Avago's Web Site: www.avagotech.com/view/rf

Ordering Information

Part Number	No. of Devices	Container
ATF-50189-BLK	100	7" Tape/Reel
ATF-50189-TR1	3000	13" Tape/Reel

SOT89 Package Dimensions

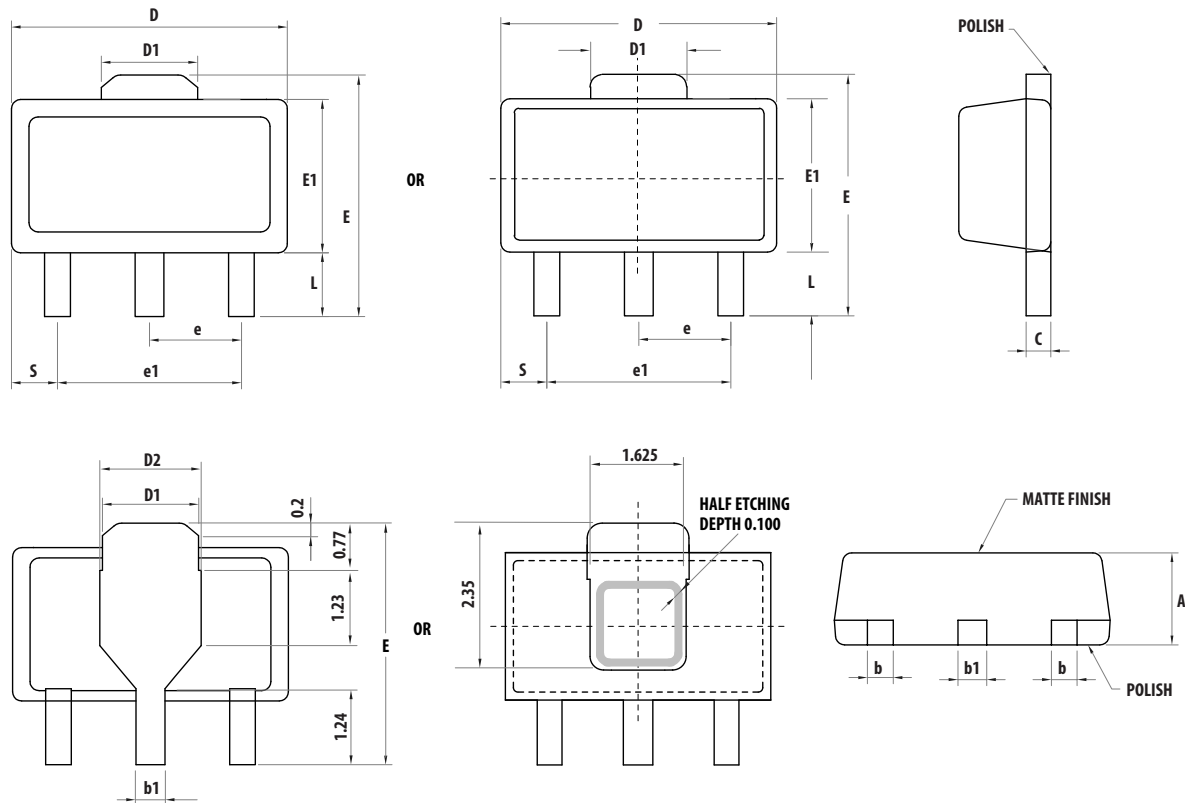

Symbols	Dimensions in mm			Dimensions in inches		
	Minimum	Nominal	Maximum	Minimum	Nominal	Maximum
A	1.40	1.50	1.60	0.055	0.059	0.063
L	0.89	1.04	1.20	0.0350	0.041	0.047
b	0.36	0.42	0.48	0.014	0.016	0.018
b1	0.41	0.47	0.53	0.016	0.018	0.030
C	0.38	0.40	0.43	0.014	0.015	0.017
D	4.40	4.50	4.60	0.173	0.177	0.181
D1	1.40	1.60	1.75	0.055	0.062	0.069
D2	1.45	1.65	1.80	0.055	0.062	0.069
E	3.94	-	4.25	0.155	-	0.167
E1	2.40	2.50	2.60	0.094	0.098	0.102
e1	2.90	3.00	3.10	0.114	0.118	0.122
S	0.65	0.75	0.85	0.026	0.030	0.034
e	1.40	1.50	1.60	0.054	0.059	0.063

Device Orientation

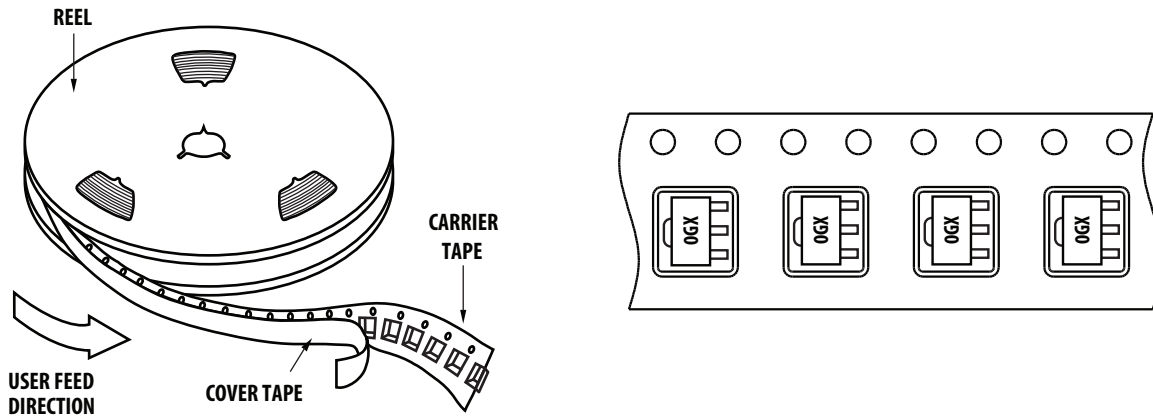

Tape Dimensions

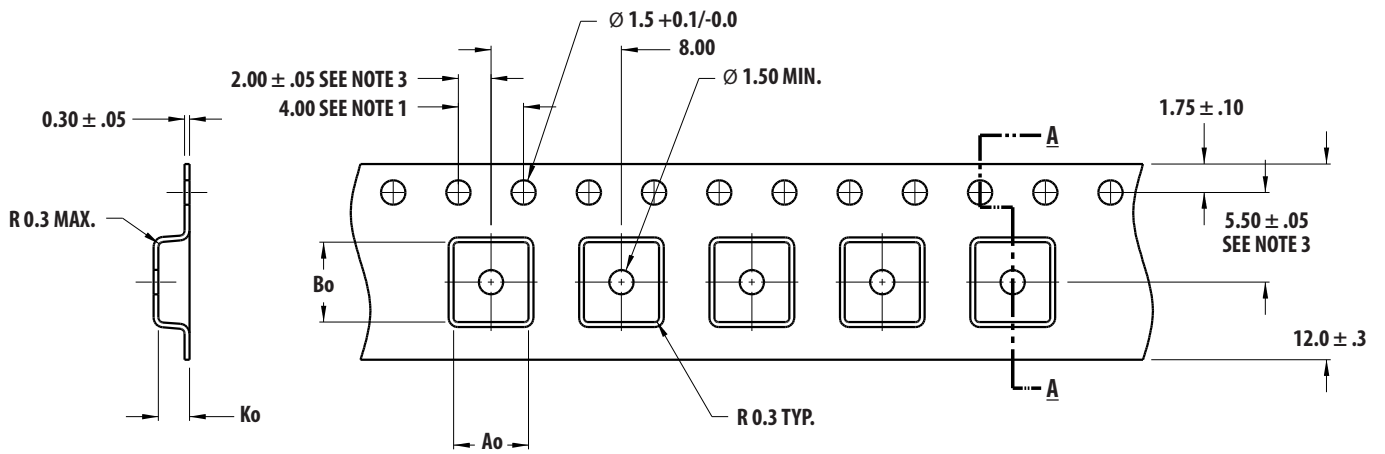

Ao = 4.60
Bo = 4.90
Ko = 1.90

DIMENSIONS IN MM

NOTES:

1. 10 SPROCKET HOLE PITCH CUMULATIVE TOLERANCE ± 0.2
2. CAMBER IN COMPLIANCE WITH EIA 481
3. POCKET POSITION RELATIVE TO SPROCKET HOLE MEASURED AS TRUE POSITION OF POCKET, NOT POCKET HOLE

Reel Dimensions – 13" Reel

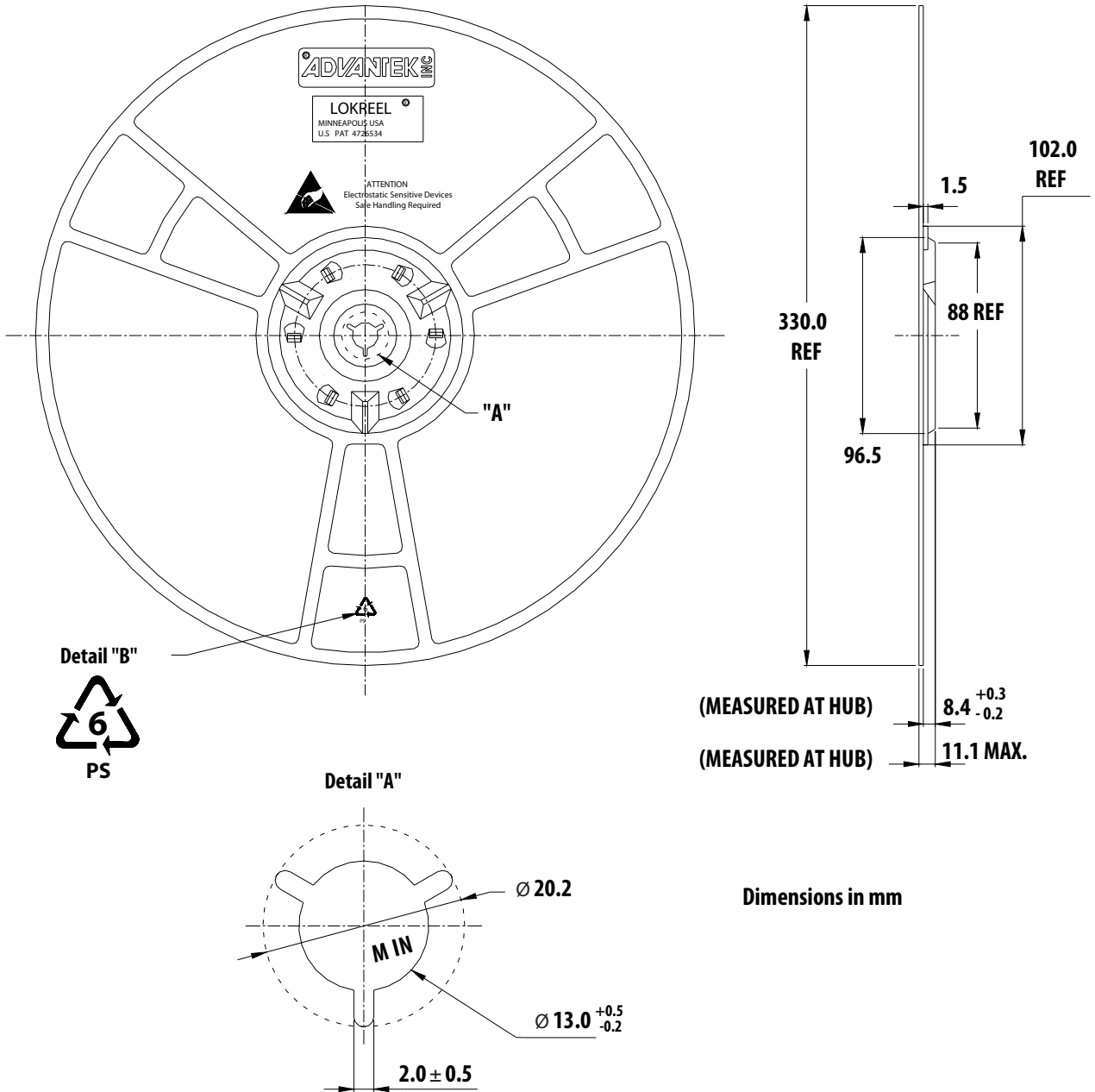

For product information and a complete list of distributors, please go to our web site: www.avagotech.com

Avago, Avago Technologies, and the A logo are trademarks of Avago Technologies in the United States and other countries. Data subject to change. Copyright © 2005-2013 Avago Technologies. All rights reserved. AV02-0049EN - November 11, 2013



Mouser Electronics

Authorized Distributor

Click to View Pricing, Inventory, Delivery & Lifecycle Information:

[Avago Technologies:](#)

[ATF-50189-BLK](#) [ATF-50189-TR1](#) [ATF-50189-TR2](#)