

## 40 V, 2 A low drop power Schottky rectifier

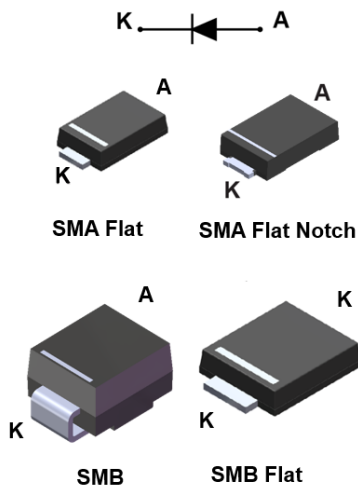

### Features

- Very small conduction losses
- Negligible switching losses
- Low forward voltage drop
- Surface mount miniature package
- Avalanche rated
- ECOPACK2 component

### Applications

- Telecom power supply
- Set-top box power supply
- TV power supply
- Battery charger

### Description

Single chip Schottky rectifiers designed for high frequency miniature switched mode power supplies such as adaptors and on board DC/DC converters.

Packaged in SMB, SMA Flat, SMA Flat Notch and SMB Flat, the **STPS2L40** is ideal for surface mounting and used in low voltage, high frequency inverters, free wheeling and polarity protection applications.

Product status	
STPS2L40	
Product summary	
Symbol	Value
$I_{F(AV)}$	2 A
$V_{RRM}$	40 V
$T_{j(max.)}$	150 °C
$V_{F(typ.)}$	0.31 V

# 1 Characteristics

**Table 1. Absolute ratings (limiting values at 25 °C, unless otherwise specified)**

Symbol	Parameter		Value	Unit	
V <sub>RRM</sub>	Repetitive peak reverse voltage		40	V	
I <sub>F(AV)</sub>	Average forward current, $\delta = 0.5$ , square wave	SMB	T <sub>L</sub> = 130 °C	2	A
		SMB Flat	T <sub>L</sub> = 140 °C		
		SMA Flat, SMA Flat Notch	T <sub>L</sub> = 130 °C		
I <sub>FSM</sub>	Surge non repetitive forward current		t <sub>p</sub> = 10 ms sinusoidal	75	A
P <sub>ARM</sub>	Repetitive peak avalanche power		t <sub>p</sub> = 10 $\mu$ s, T <sub>j</sub> = 125 °C	158	W
T <sub>stg</sub>	Storage temperature range		-65 to +150		°C
T <sub>j</sub>	Maximum operating junction temperature <sup>(1)</sup>		+150		°C

1.  $(dP_{tot}/dT_j) < (1/R_{th(j-a)})$  condition to avoid thermal runaway for a diode on its own heatsink.

**Table 2. Thermal resistance parameter**

Symbol	Parameter	Max. value	Unit	
R <sub>th(j-l)</sub>	Junction to lead	SMB	20	°C/W
		SMB Flat	10	
		SMA Flat	20	
		SMA Flat Notch	20	

For more information, please refer to the following application note :

- AN5088 : Rectifiers thermal management, handling and mounting recommendations

**Table 3. Static electrical characteristics**

Symbol	Parameter	Test conditions		Min.	Typ.	Max.	Unit
I <sub>R</sub> <sup>(1)</sup>	Reverse leakage current	T <sub>j</sub> = 25 °C	V <sub>R</sub> = 40 V	-		220	$\mu$ A
		T <sub>j</sub> = 100 °C		-		20	mA
		T <sub>j</sub> = 125 °C		-	38	80	mA
V <sub>F</sub> <sup>(1)</sup>	Forward voltage drop	T <sub>j</sub> = 25 °C	I <sub>F</sub> = 1 A	-		0.39	V
		T <sub>j</sub> = 125 °C		-	0.25	0.28	
		T <sub>j</sub> = 25 °C	I <sub>F</sub> = 2 A	-		0.43	
		T <sub>j</sub> = 125 °C		-	0.31	0.34	
		T <sub>j</sub> = 25 °C	I <sub>F</sub> = 4 A	-		0.50	
		T <sub>j</sub> = 125 °C		-	0.39	0.45	

1. Pulse test: t<sub>p</sub> = 380  $\mu$ s,  $\delta < 2\%$

To evaluate the conduction losses, use the following equation:

$$P = 0.22 \times I_{F(AV)} + 0.06 \times I_{F(RMS)}^2$$

For more information, please refer to the following application notes related to the power losses :

- AN604: Calculation of conduction losses in a power rectifier
- AN4021: Calculation of reverse losses on a power diode

### 1.1 Characteristics (curves)

**Figure 1. Average forward power dissipation versus average forward current**

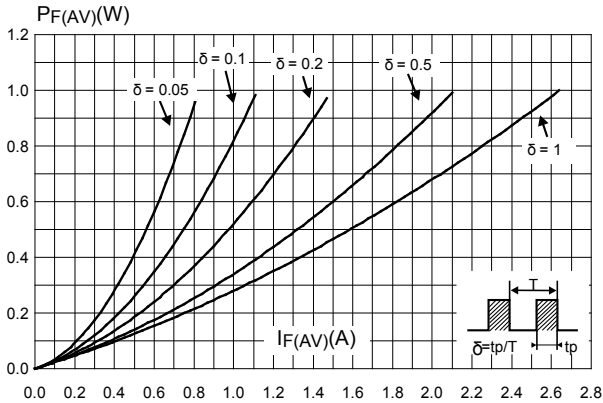

**Figure 2. Average forward current versus ambient temperature ( $\delta = 0.5$ ) SMB**

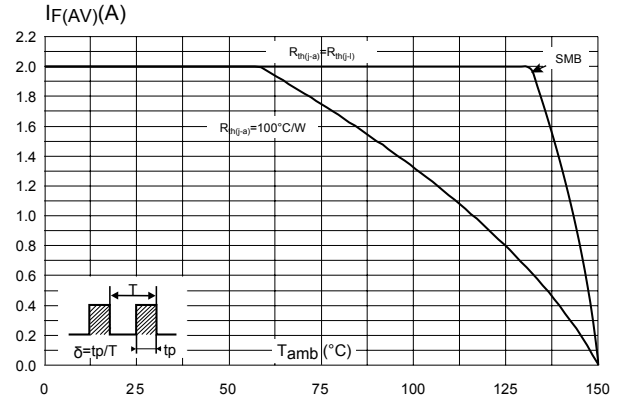

**Figure 3. Average forward current versus ambient temperature ( $\delta = 0.5$ , SMB Flat)**

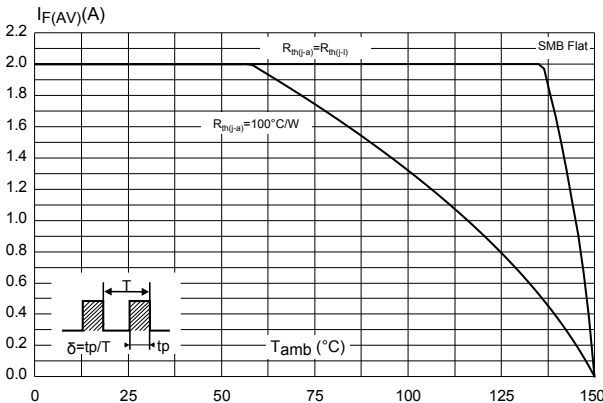

**Figure 4. Average forward current versus ambient temperature ( $\delta = 0.5$ , SMA Flat, SMA Flat Notch)**

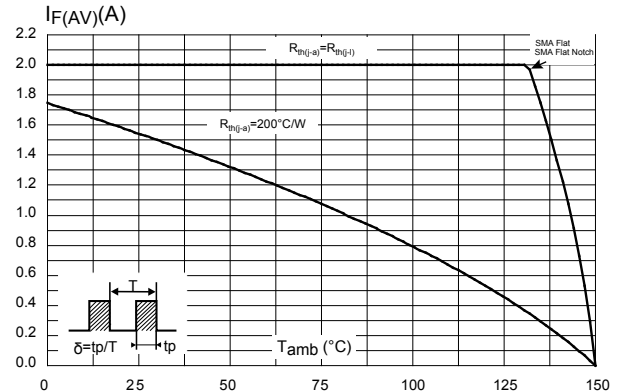

**Figure 5. Normalized avalanche power derating versus pulse duration ( $T_j = 125\text{ °C}$ )**

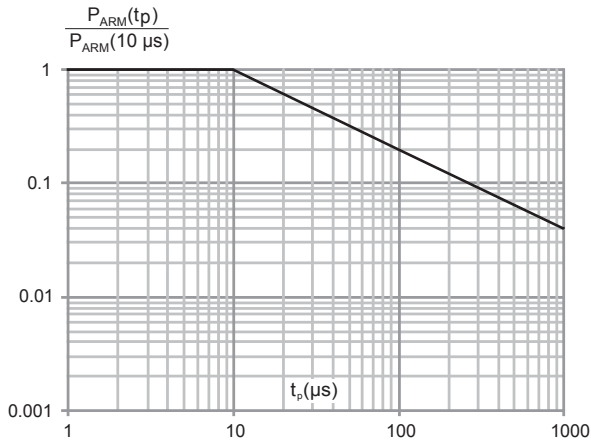

**Figure 6. Relative variation of thermal impedance junction to ambient versus pulse duration (SMB)**

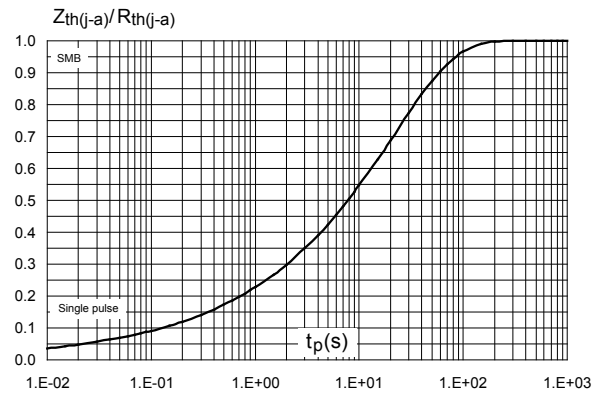

**Figure 7. Relative variation of thermal impedance junction to lead versus pulse duration (SMB flat)**

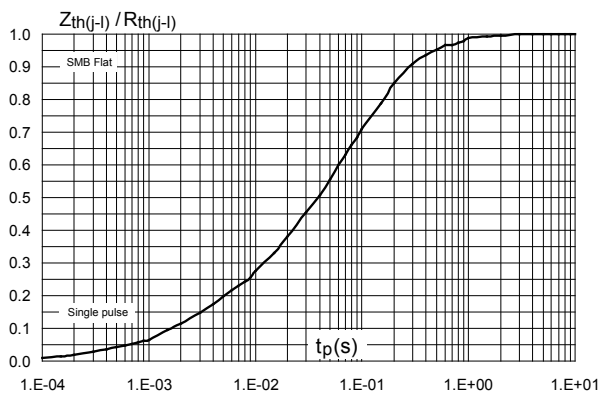

**Figure 8. Relative variation of thermal impedance junction to ambient versus pulse duration (SMA Flat)**

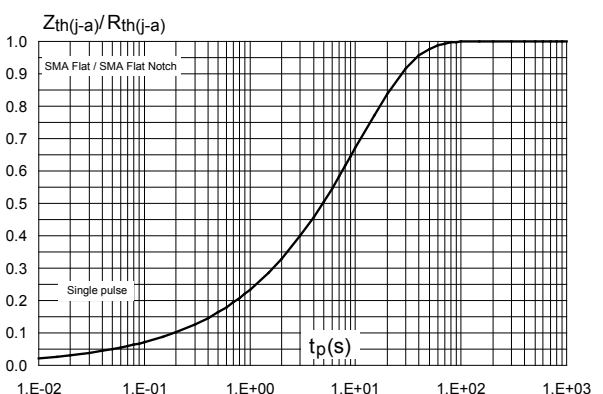

**Figure 9. Reverse leakage current versus reverse voltage applied (typical values)**

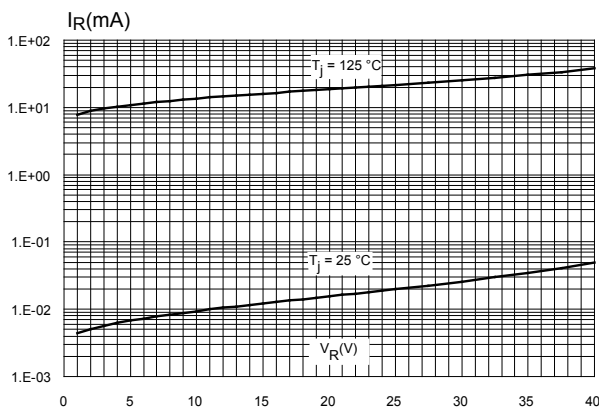

**Figure 10. Junction capacitance versus reverse voltage applied (typical values)**

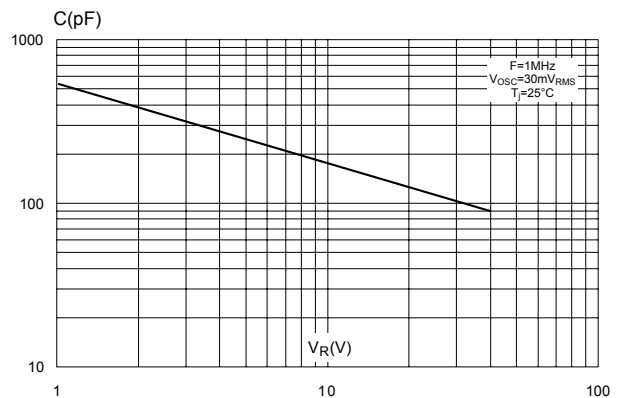

**Figure 11. Forward voltage drop versus forward current (high level)**

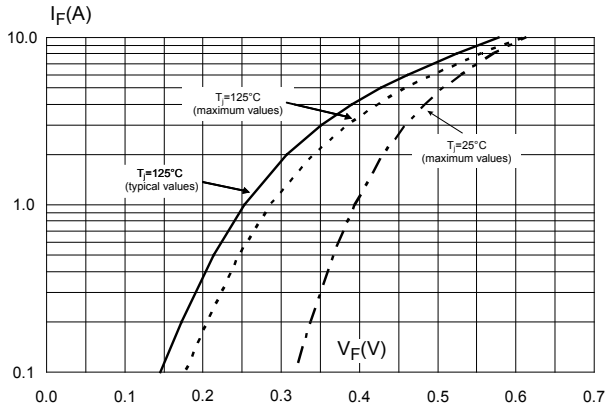

**Figure 12. Forward voltage drop versus forward current (low level)**

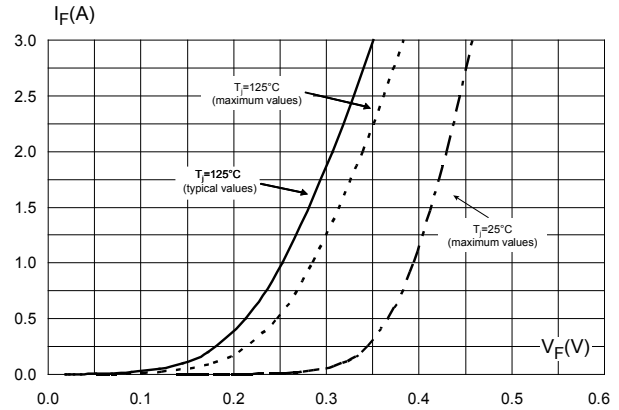

**Figure 13. Thermal resistance junction to ambient versus copper surface under each lead (SMB)**

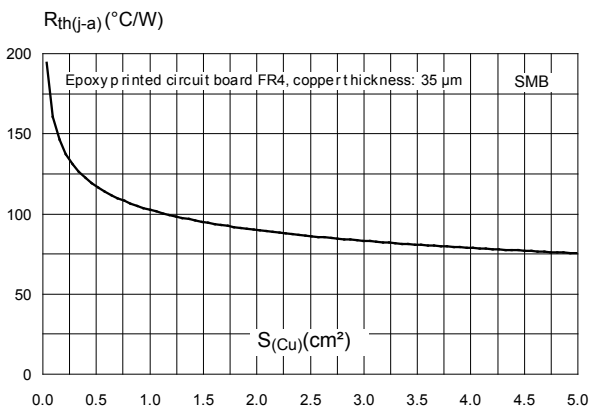

**Figure 14. Thermal resistance junction to ambient versus copper surface under each lead (SMB flat)**

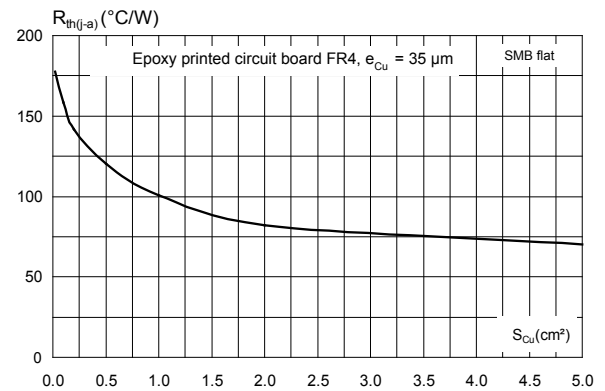

**Figure 15. Thermal resistance junction to ambient versus copper surface under each lead (SMA Flat, SMA Flat Notch)**

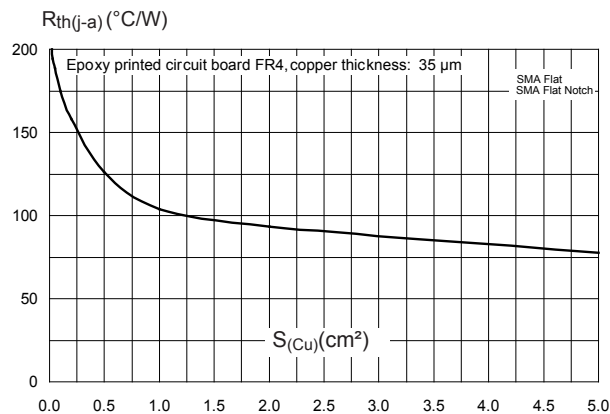

## 2 Package information

In order to meet environmental requirements, ST offers these devices in different grades of **ECOPACK** packages, depending on their level of environmental compliance. ECOPACK specifications, grade definitions and product status are available at: [www.st.com](http://www.st.com). ECOPACK is an ST trademark.

### 2.1 SMB package information

- Epoxy meets UL94, V0
- Lead-free package

**Figure 16. SMB package outline**

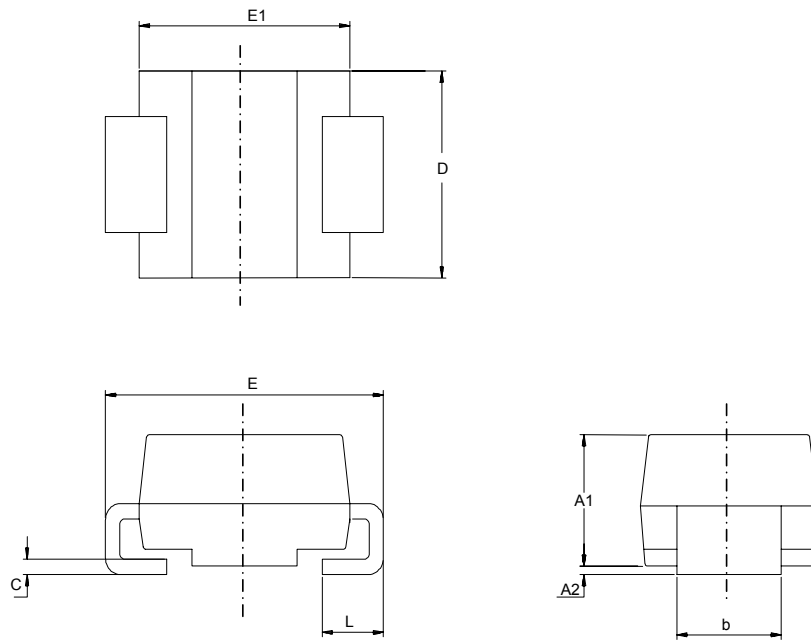

**Table 4. SMB package mechanical data**

Ref.	Dimensions			
	Millimeters		Inches (for reference only)	
	Min.	Max.	Min.	Max.
A1	1.90	2.45	0.074	0.097
A2	0.05	0.20	0.001	0.008
b	1.95	2.20	0.076	0.087
c	0.15	0.40	0.005	0.016
D	3.30	3.95	0.129	0.156
E	5.10	5.60	0.200	0.221
E1	4.05	4.60	0.159	0.182
L	0.75	1.50	0.029	0.060

**Figure 17. SMB recommended footprint**

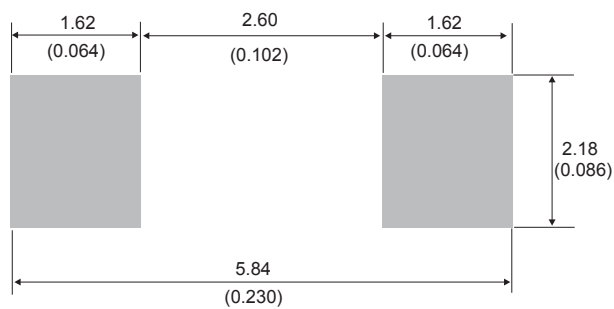



## 2.2 SMB Flat package information

- Epoxy meets UL94, V0
- Lead-free package

**Figure 18. SMB Flat package outline**

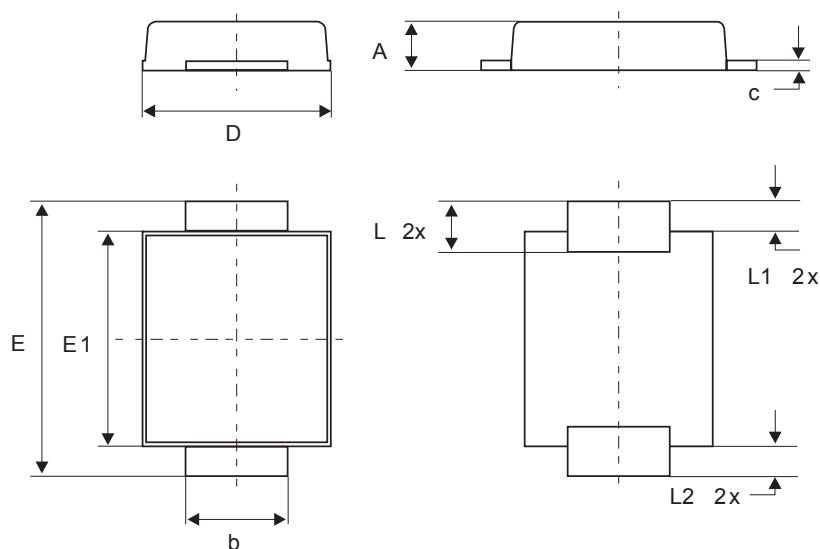

**Table 5. SMB Flat mechanical data**

Ref.	Dimensions					
	Millimeters			Inches		
	Min.	Typ.	Max.	Min.	Typ.	Max.
A	0.90		1.10	0.035		0.044
b	1.95		2.20	0.076		0.087
c	0.15		0.40	0.005		0.016
D	3.30		3.95	0.129		0.156
E	5.10		5.60	0.200		0.221
E1	4.05		4.60	0.159		0.182
L	0.75		1.50	0.029		0.060
L1		0.40			0.016	
L2		0.60			0.024	

**Figure 19. Footprint recommendations, dimensions in mm (inches)**

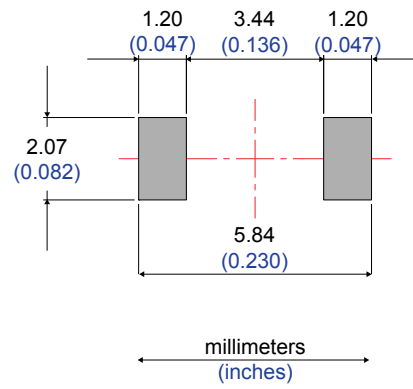

### 2.3 SMA Flat package information

- Epoxy meets UL94, V0
- Lead-free package

Figure 20. SMA Flat package outline

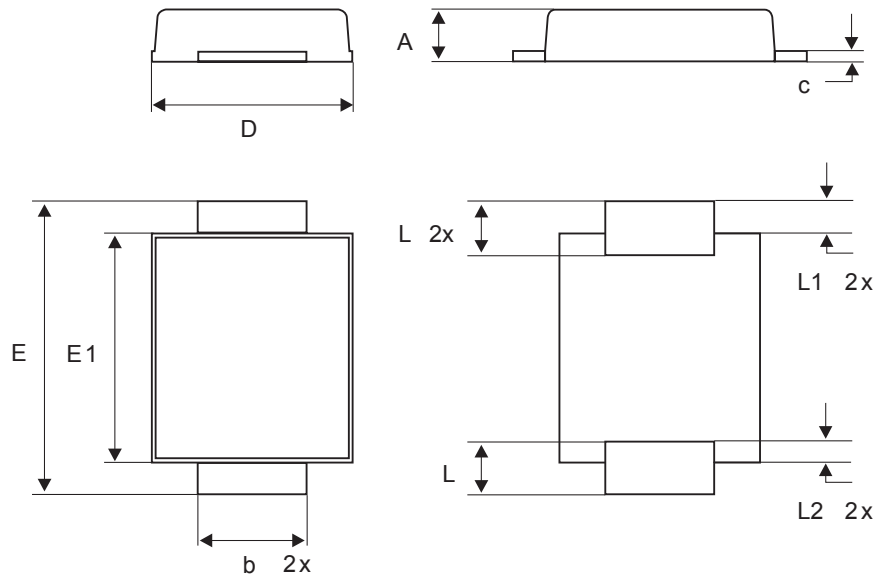
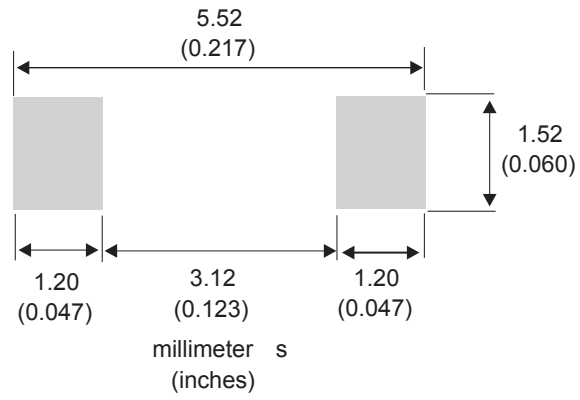

Table 6. SMA Flat package mechanical data

Ref.	Dimensions					
	Millimeters			Inches (for reference only)		
	Min.	Typ.	Max.	Min.	Typ.	Max.
A	0.90		1.10	0.035		0.044
b	1.25		1.65	0.049		0.065
c	0.15		0.40	0.005		0.016
D	2.25		2.95	0.088		0.117
E	4.80		5.60	0.188		0.221
E1	3.95		4.60	0.155		0.182
L	0.75		1.50	0.029		0.060
L1		0.50			0.020	
L2		0.50			0.020	

**Figure 21. SMA Flat recommended footprint in mm (inches)**



## 2.4 SMA Flat Notch package information

- Epoxy meets UL94, V0
- Cooling method: by conduction (C)
- Band indicates cathode

Figure 22. SMA Flat Notch package outline

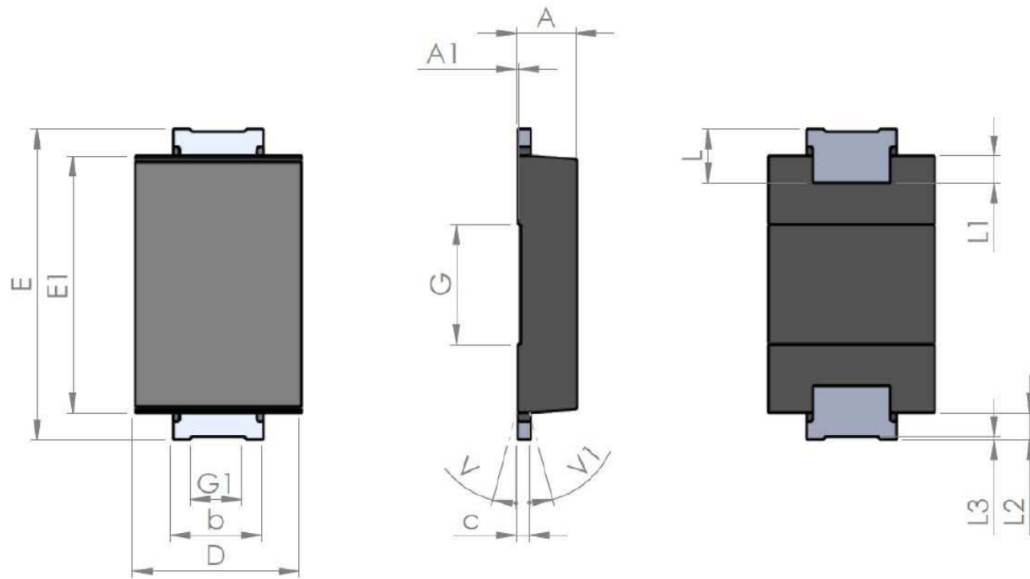
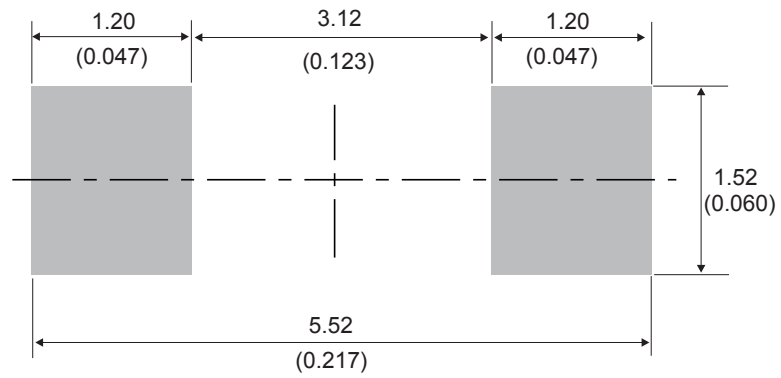

Table 7. SMA Flat Notch package mechanical data

Ref.	Dimensions					
	Millimeters			Inches (for reference only)		
	Min.	Typ.	Max.	Min.	Typ.	Max.
A1	0.90		1.10	0.035		0.044
A1		0.05			0.002	
b	1.25		1.65	0.049		0.065
C	0.15		0.40	0.005		0.016
D	2.25		2.90	0.088		0.115
E	5.00		5.35	0.196		0.211
E1	3.95		4.60	0.155		0.182
G		2.00			0.079	
G1		0.85			0.033	
L	0.75		1.20	0.029		
L1		0.45			0.018	
L2		0.45			0.018	
L3		0.05			0.002	
V			8°			8°
V1			8°			8°

Figure 23. SMA Flat Notch recommended footprint in mm (inches)



### 3 Ordering information

**Table 8. Ordering information**

Order code	Marking	Package	Weight	Base qty.	Delivery mode
STPS2L40U	GD4	SMB	0.107 g	2500	Tape and reel
STPS2L40UF	FGD4	SMB Flat	0.050 g	5000	Tape and reel
STPS2L40AF	F2L4	SMA Flat	0.035 g	10 000	Tape and reel
STPS2L40AFN	A24	SMA Flat Notch	0.039 g	10 000	Tape and reel

## Revision history

**Table 9. Document revision history**

Date	Version	Changes
Jul-2003	2A	Last update.
31-Jan-2007	3	Reformatted to current standard. Added ECOPACK statement. Added SMBflat package.
18-Sep-2008	4	Reformatted to current standard. Updated ECOPACK statement. Added SMAflat package.
04-Dec-2018	5	Updated <a href="#">Table 1</a> . Absolute ratings (limiting values at 25 °C, unless otherwise specified) and <a href="#">Figure 5</a> . Normalized avalanche power derating versus pulse duration ( $T_j = 125\text{ °C}$ ).
27-Sep-2019	6	Added <a href="#">Section 2.4</a> SMA Flat Notch package information.



**IMPORTANT NOTICE – PLEASE READ CAREFULLY**

STMicroelectronics NV and its subsidiaries (“ST”) reserve the right to make changes, corrections, enhancements, modifications, and improvements to ST products and/or to this document at any time without notice. Purchasers should obtain the latest relevant information on ST products before placing orders. ST products are sold pursuant to ST’s terms and conditions of sale in place at the time of order acknowledgement.

Purchasers are solely responsible for the choice, selection, and use of ST products and ST assumes no liability for application assistance or the design of Purchasers’ products.

No license, express or implied, to any intellectual property right is granted by ST herein.

Resale of ST products with provisions different from the information set forth herein shall void any warranty granted by ST for such product.

ST and the ST logo are trademarks of ST. For additional information about ST trademarks, please refer to [www.st.com/trademarks](http://www.st.com/trademarks). All other product or service names are the property of their respective owners.

Information in this document supersedes and replaces information previously supplied in any prior versions of this document.

© 2019 STMicroelectronics – All rights reserved

# Mouser Electronics

Authorized Distributor

Click to View Pricing, Inventory, Delivery & Lifecycle Information:

[STMicroelectronics:](#)

[STPS2L40U](#) [STPS2L40UF](#) [STPS2L40AF](#) [STPS2L40AFN](#)