

Fair-Rite Products Corp.

Ferrite Components for the Electronics Industry



®



17th Edition

Your Signal Solution®

Our Position on Quality And the Environment

Fair-Rite Products Corp. is committed to be "Your Signal Solution". Management and employees continue to adhere to the ISO/TS 16949 quality system, in effect at the time of the printing of this catalog revision, providing continual improvement towards defect prevention, variation reduction and customer satisfaction. We are committed to offering high quality products and services while maintaining an environmentally friendly and sustainable manufacturing process. As a responsible member of the corporate and local community, Fair-Rite continues to stay proactive in compliance with local, national and international environmental regulations regarding manufacturing, emissions and documentation.

Modern value enhancement tools, including Control Plans, Advanced Product Quality Planning (APQP), Production Part Approval Process (PPAP), Failure Mode and Effects Analysis (FMEA) and Feasibility Assessments, are available for the quality planning process. Contract review, design control, and the purchasing function all meet the requirements of ISO/TS 16949. Process and product control, including measurement, traceability, handling and delivery, meet the highest quality standards. Any nonconforming or suspect product is tracked. Corrective and preventive actions, statistical methods, and internal audits are applied to guarantee continual improvement. Extensive training is provided to all employees to support the system. Product inspection, tests and records verify that specified requirements are met. Critical characteristics are monitored by statistical methods, including pre-control, control charts, and SPC. Process capability indices, Cpk's, are targeted to exceed 1.33 for these critical characteristics. When sampling plans are employed, zero defects are allowed in any sample. Visual inspection criteria for chips, cracks and surface finish are documented. IEC Standard 60424 is used as a guide for evaluation of visual imperfections. For product types not defined by IEC Standard 60424, customer specific, or Fair-Rite's visual inspection criteria shall apply.

All Fair-Rite Products Corp. components are RoHS and REACH compliant per the thresholds in effect at the time of the printing of this catalog revision. Termination wire used on all board level components and the plated contacts on chip components have 100% matte tin plating over a nickel undercoating. The polypropylene cases used to assemble Fair-Rite "Snap-It" cores do not contain PBB or PBDE as a flame retardant.

Fair-Rite Products Corp. adheres to the practice of continual improvement. Therefore, in order to offer our customers optimized designs, the company reserves the right to change materials, designs, dimensions, etc. at any time without notice.

Table of Contents

| | |
|--|-------|
| Our Position on Quality and the Environment | I.F.C |
| Introduction | 2 |
| Magnetic Properties of Fair-Rite Materials | 4 |
| Fair-Rite Materials | 8 |
| Board Components | |
| Solder Profile | 34 |
| EMI Suppression Beads | 35 |
| Beads on Leads | 39 |
| PC Beads (Through Hole) | 42 |
| Wound Beads | 44 |
| Multi-Aperture Cores | 47 |
| SM Beads (Differential-Mode) | 50 |
| SM Beads (Common-Mode) | 55 |
| Chip Beads | 58 |
| Chip Arrays | 64 |
| Engineering Kits | |
| Cable Components | |
| Round Cable EMI Suppression Cores | 75 |
| Round Cable Snap-Its | 80 |
| Flat Cable EMI Suppression Cores | 84 |
| Flat Cable Cores Assembly Clips | 87 |
| Flat Cable Snap-Its | 88 |
| Connector EMI Suppression Plates | 89 |
| Miscellaneous Suppression Cores | 91 |
| Inductive Components | |
| Open Magnetic Circuit | |
| Rods | 93 |
| Rod Information | 95 |
| Antenna/RFID Rods | 97 |
| Bobbins | 99 |
| Closed Magnetic Circuit | |
| Toroids | 102 |
| Planar Cores | 111 |
| Pot Cores | 114 |
| RM Cores | 116 |
| PQ Cores | 118 |
| E Cores | 120 |
| EFD Cores | 122 |
| ETD Cores | 124 |
| EER Cores | 126 |
| U Cores | 128 |
| EP Cores | 130 |
| Product Capability | 132 |
| References | |
| Reference Tables | 134 |
| Glossary of Terms | 135 |
| Soft Ferrite References | 136 |
| Magnetic Design Formulas | 138 |
| Wire Table of Copper Magnet Wire | 139 |
| Technical Articles | |
| Use of Ferrites in Broadband Transformers | 140 |
| How to Choose Ferrite Components for EMI Suppression | 144 |
| Part Number Index | 154 |

Copyright © 2013 by Fair-Rite Products Corp.

All rights reserved. No part of the contents of this book may be published or transmitted in any form or by any means without the expressed written permission of Fair-Rite Products Corp.

Fair-Rite Products Corp. PO Box 288, One Commercial Row, Wallkill, NY 12589-0288

Phone: (888) FAIR RITE / (845) 895-2055 • Fax: (888) FERRITE / (845) 895-2629 • Web: www.fair-rite.com
 (888) 324-7748 (888) 337-7483 E-mail: ferrites@fair-rite.com

Introduction

History

The history of magnetism began with the discovery of the properties of a mineral called magnetite (Fe_3O_4). The most plentiful deposits were found in the district of Magnesia in Asia Minor (hence the mineral's name) where it was observed, centuries before the birth of Christ, that these naturally occurring stones would attract iron. Later on it found application in the lodestone of early navigators. In 1600 William Gilbert published *De Magnete*, the first scientific study on magnetism. In 1819 Hans Christian Oersted observed that an electric current in a wire affected a magnetic compass needle, thus with later contributions by Faraday, Maxwell, Hertz and others, the new science of electromagnetism came into being.

Even though the existence of naturally occurring magnetite, a weak type of hard ferrite, had been known since antiquity, producing an analogous soft magnetic material in the laboratory proved elusive. Research on magnetic oxides was going on concurrently during the 1930's, primarily in Japan and The Netherlands. However, it was not until 1945 that J. L. Snoek of the Philips' Research Laboratories in The Netherlands succeeded in producing a soft ferrite material for commercial applications.

Fair-Rite Products Corp. was not far behind in the manufacture and sale of soft ferrites for use in the electronics industry. It was formed in 1952 and officially started operations in 1953. The ensuing years have seen a rather crude product, which was available in only a few shapes and materials, develop into a major line of ferrite components for inductive devices, produced in many core configurations with a wide selection of materials. The application of ferrites in EMI suppression as shield beads and broadband chokes, where an effective resistive impedance is produced at high frequencies, has grown so fast in the last decade, that their use as EMI suppressors is limited only by the imagination of the end user.

Soft Ferrites

The single most important characteristic of soft ferrites, as compared to other magnetic materials, is the high volume resistivity exhibited in the monolithic form. Since eddy current losses are inversely proportional to resistivity and these losses increase with the square of the frequency, high resistivity becomes an essential factor in magnetic materials intended for high frequency operation. The magnetic properties of ferrite components are isotropic, and by employing various pressing, injection molding, and/or grinding techniques, a wide range of complex shapes can be formed. There is no other class of magnetic material that can match soft ferrites in performance, cost and volumetric efficiency, from audio frequencies into the GHz range.

During the last 50 years the basic constituents of ferrites have changed little, but purity of raw materials and process control have improved dramatically. Ferrites are ceramic materials with the general chemical formula $\text{MO}\cdot\text{Fe}_2\text{O}_3$, where MO is one or more divalent metal oxides blended with 48 to 60 mole percent

of iron oxide. Fair-Rite manufactures four broad groups of soft ferrite materials:

Manganese zinc (Fair-Rite 31, 33, 73, 75, 76, 77, 78, 79, 97, 95 and 98 material)

Nickel zinc (Fair-Rite 43, 44, 51, 52, 61, 67 and 68 material)

Manganese (Fair-Rite 85 material – special order)

Magnesium zinc (Fair-Rite 46 material)

Manganese zinc ferrites are completely vitrified and have very low porosity. They have the highest permeabilities and exhibit volume resistivities ranging from one hundred to several thousand ohm-centimeter. Manganese zinc ferrite components are used in tuned circuits and magnetic power designs from the low kilohertz range into the broadcast spectrum. These ferrites have a linear expansion coefficient of approximately 10 ppm/°C,

The nickel zinc ferrites vary in porosity, and frequently contain oxides of other metals, such as those of magnesium, manganese, copper or cobalt. Volume resistivities range from several kilohm-centimeter to tens of megohm-centimeter. In general, they are used at higher frequencies (above 1 MHz), and are suitable for low flux density applications. Nickel zinc ferrites have a linear expansion coefficient of approximately 8 ppm/°C.

The manganese ferrite is a dense, temperature stable material displaying a high degree of squareness in its hysteresis loop. This makes this material uniquely suited for such applications as multiple output control in switched-mode power supplies and high frequency magnetic amplifiers.

The magnesium zinc ferrite has similar characteristics as NiZn ferrite. The composition of MgZn material does not contain any nickel, hence avoiding potential environmental issues as well as reducing the raw material component cost.

As is evident from the flow diagram on page 3, there is considerable processing involved, and the manufacturing cycle will take a minimum of two weeks. The parts listed in the catalog represent a broad cross section of the wide variety of cores produced by Fair-Rite Products. Large OEM quantities are manufactured by Fair-Rite to order. Most of the more commonly used parts are stocked by our distributors, offering prompt deliveries. For a complete listing of our distributors visit our site on the Internet at www.fair-rite.com.

Many of the parts produced by Fair-Rite are made to customer specifications, and we welcome inquiries involving application specific designs. We have the capability to design tooling rapidly, and have it fabricated either by our own tool shop or by outside vendors.

Footnote: *The difference between hard and soft ferrite is not tactile, but rather a magnetic characteristic.*

Soft ferrite does not retain significant magnetization, whereas hard ferrite magnetization is considered permanent.

Introduction

Simplified Process Flow Diagram

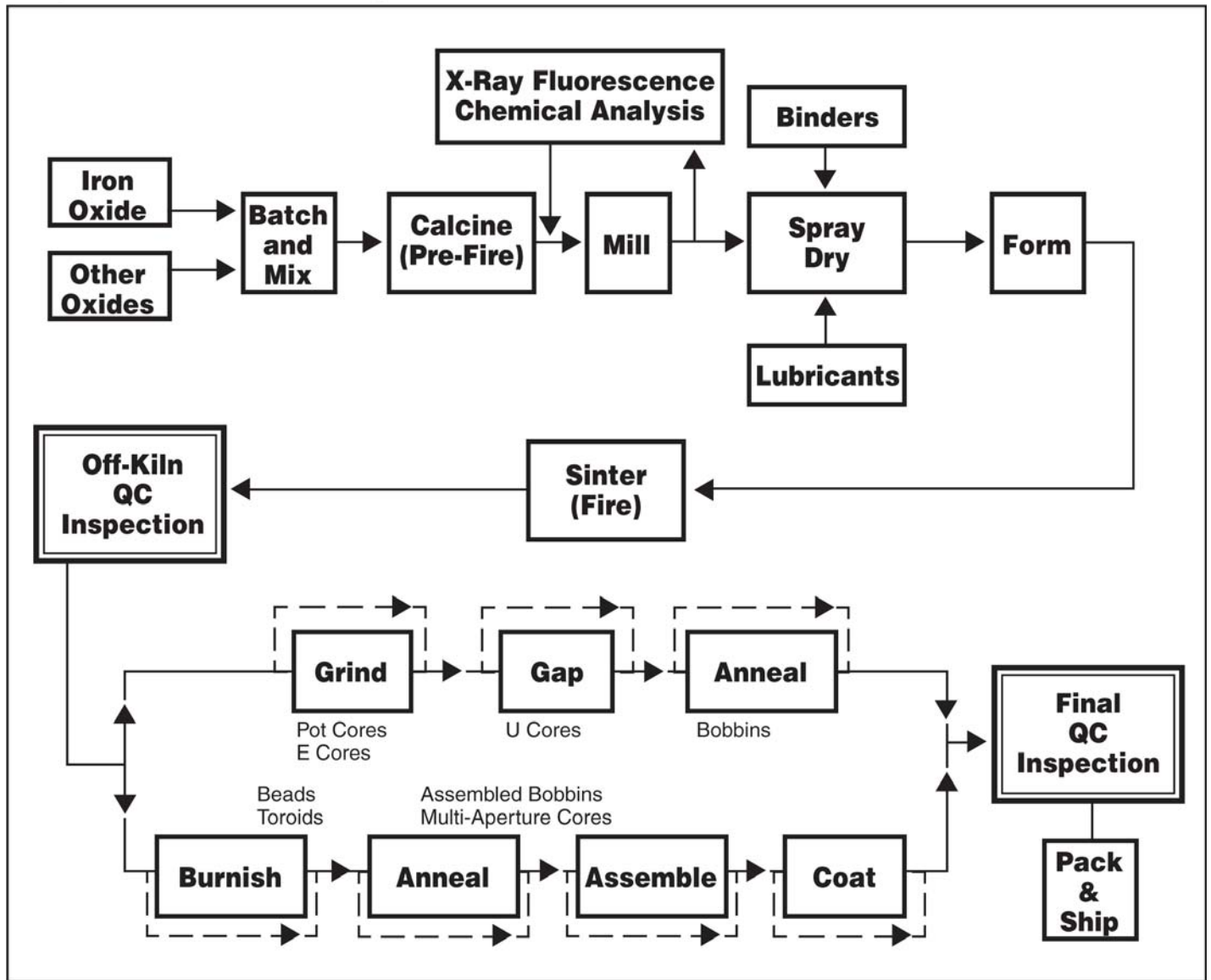

Fair-Rite Products Corp.
 CAGE # 34899
 Federal ID# 141389596

Ferrite Cores
 Standard Industrial Classification (SIC) 3264
 North American Industry
 Classification System (NAICS) 327113

Fair-Rite Products Corp. PO Box 288, One Commercial Row, Wallkill, NY 12589-0288

Phone: (888) FAIR RITE / (845) 895-2055 • Fax: (888) FERRITE / (845) 895-2629 • Web: www.fair-rite.com
 (888) 324-7748 (888) 337-7483 E-mail: ferrites@fair-rite.com

Magnetic Properties of Ferrite Materials

| Property | Unit | Symbol | 68 | 67 | 61 | 52 | 51 | 44 |
|--|--------------------------|-----------------------|--------|--------|----------|----------|--------|--------|
| Initial Permeability @ B <10 gauss | | μ_i | 16 | 40 | 125 | 250 | 350 | 500 |
| Flux Density @ Field Strength | gauss | B | 2700 | 2300 | 2350 | 4200 | 3200 | 3000 |
| | mT | | 270 | 230 | 235 | 420 | 320 | 300 |
| | oersted | H | 40 | 20 | 15 | 10 | 10 | 10 |
| | A/m | | 3200 | 1600 | 1200 | 800 | 800 | 800 |
| Residual Flux Density | gauss | B_r | 1000 | 800 | 1200 | 2900 | 1200 | 1100 |
| | mT | | 100 | 80 | 120 | 290 | 120 | 110 |
| Coercive Force | oersted | H_c | 7 | 3.5 | 1.8 | 0.6 | 0.6 | 0.45 |
| | A/m | | 560 | 280 | 144 | 48 | 48 | 36 |
| Loss Factor @ Frequency | 10^{-6} | $\tan \delta / \mu_i$ | 500 | 150 | 30 | 45 | 40 | 125 |
| | MHz | | 100 | 50 | 1 | 1 | 1 | 1 |
| Temperature Coefficient of Initial Permeability (20 - 70°C) | %/°C | T.C. | 0.10 | 0.05 | 0.10 | 1.00 | 0.80 | 0.75 |
| Curie Temperature | °C | T_c | >500 | >475 | >300 | >250 | >170 | >160 |
| Resistivity | ohm-cm | ρ | 10^7 | 10^7 | 10^8 | 10^9 | 10^9 | 10^9 |
| Power Loss Density 25kHz - 2000 G - 100°C 100kHz - 1000 G - 100°C 100kHz - 2000 G - 100°C 500kHz - 500 G - 100°C | mW/cm ³ | P | -- | -- | -- | -- | -- | -- |
| | | | -- | -- | -- | -- | -- | -- |
| | | | -- | -- | -- | -- | -- | -- |
| | | | -- | -- | -- | -- | -- | -- |
| Recommended Frequency Range | MHz | | | | | | | |
| Application Area | Low flux density devices | | <400 | <300 | <100 | <20 | -- | -- |
| | EMI suppression | | -- | -- | 200-2000 | 200-1000 | <200 | 25-300 |
| | Power magnetics | | -- | -- | -- | -- | -- | -- |
| See this page for additional material data | | | 8 | 9 | 10 | 11 | 12 | 13 |

Magnetic Properties of Ferrite Materials

| Property | Unit | Symbol | 46 | 33 | 43 | 79 | 31 | 77 |
|--|--------------------------|-----------------------|--------|------|--------|-------|-------|-------|
| Initial Permeability @ B <10 gauss | | μ_i | 500 | 600 | 800 | 1400 | 1500 | 2000 |
| Flux Density @ Field Strength | gauss | B | 3000 | 2800 | 2900 | 4700 | 3400 | 4900 |
| | mT | | 300 | 280 | 290 | 470 | 340 | 490 |
| | oersted | H | 10 | 5 | 10 | 5 | 5 | 5 |
| | A/m | | 800 | 400 | 800 | 400 | 400 | 400 |
| Residual Flux Density | gauss | B_r | 1900 | 1200 | 1300 | 1700 | 2500 | 1800 |
| | mT | | 190 | 120 | 130 | 170 | 250 | 180 |
| Coercive Force | oersted | H_c | 0.4 | 0.6 | 0.45 | 0.4 | 0.35 | 0.3 |
| | A/m | | 32 | 48 | 36 | 32 | 28 | 24 |
| Loss Factor @ Frequency | 10^{-6} | $\tan \delta / \mu_i$ | 60 | 25 | 250 | 4 | 20 | 15 |
| | MHz | | 0.1 | 0.2 | 1 | 0.1 | 0.1 | 0.1 |
| Temperature Coefficient of Initial Permeability (20 - 70°C) | %/°C | T.C. | -- | 0.10 | 1.25 | 0.60 | 1.60 | 0.70 |
| Curie Temperature | °C | T_c | >140 | >150 | >130 | >225 | >130 | >200 |
| Resistivity | ohm-cm | ρ | 10^8 | 100 | 10^5 | 200 | 3000 | 100 |
| Power Loss Density 25kHz - 2000 G - 100°C 100kHz - 1000 G - 100°C 100kHz - 2000 G - 100°C 500kHz - 500 G - 100°C | mW/cm ³ | P | -- | -- | -- | -- | -- | 200 |
| | | | -- | -- | -- | -- | -- | -- |
| | | | -- | -- | -- | -- | -- | -- |
| | | | -- | -- | -- | 80 | -- | -- |
| Recommended Frequency Range | MHz | | | | | | | |
| Application Area | Low flux density devices | | -- | <3 | <10 | -- | -- | <3 |
| | EMI suppression | | 25-300 | -- | 25-300 | -- | 1-300 | -- |
| | Power magnetics | | -- | -- | -- | <0.75 | -- | <0.1 |
| See this page for additional material data | | | 14 | 15 | 16 | 18/19 | 17 | 20/21 |

Magnetic Properties of Ferrite Materials

| Property | Unit | Symbol | 97 | 78 | 98 | 73 | 95 | 75 | 76 |
|--|--------------------------|-----------------------|-------|-------|-------|------|-------|-------|-------|
| Initial Permeability @ B <10 gauss | | μ_i | 2000 | 2300 | 2400 | 2500 | 3000 | 5000 | 10000 |
| Flux Density @ Field Strength | gauss | B | 5000 | 4800 | 5000 | 3900 | 5000 | 4300 | 4000 |
| | mT | | 500 | 480 | 500 | 390 | 500 | 430 | 400 |
| | oersted | H | 5 | 5 | 5 | 5 | 5 | 5 | 5 |
| | A/m | | 400 | 400 | 400 | 400 | 400 | 400 | 400 |
| Residual Flux Density | gauss | Br | 1500 | 1500 | 1800 | 1500 | 800 | 1400 | 1800 |
| | mT | | 150 | 150 | 180 | 150 | 80 | 140 | 180 |
| Coercive Force | oersted | Hc | 0.16 | 0.2 | 0.17 | 0.24 | 0.13 | 0.16 | 0.12 |
| | A/m | | 13 | 16 | 14 | 19.2 | 10 | 13 | 9.6 |
| Loss Factor @ Frequency | 10^{-6} | $\tan \delta / \mu_i$ | 3.5 | 4.5 | 3.5 | 10 | 3 | 15 | 15 |
| | MHz | | 0.1 | 0.1 | 0.1 | 0.1 | 0.1 | 0.1 | 0.025 |
| Temperature Coefficient of Initial Permeability (20 - 70°C) | %/°C | T.C. | 1.40 | 1.00 | 1.50 | 0.65 | 0.40 | 0.60 | 0.50 |
| Curie Temperature | °C | Tc | >220 | >200 | >215 | >160 | >220 | >140 | >120 |
| Resistivity | ohm-cm | ρ | 200 | 200 | 200 | 100 | 200 | 300 | 50 |
| Power Loss Density 25kHz - 2000 G - 100°C 100kHz - 1000 G - 100°C 100kHz - 2000 G - 100°C 500kHz - 500 G - 100°C | mW/cm ³ | P | -- | 75 | -- | -- | -- | 140 | -- |
| | | | 50 | 85 | 50 | -- | 50 | -- | -- |
| | | | 320 | -- | 310 | -- | 310 | -- | -- |
| | | | -- | -- | -- | -- | -- | -- | -- |
| Recommended Frequency Range | MHz | | | | | | | | |
| Application Area | Low flux density devices | | -- | <2.5 | -- | -- | -- | <0.75 | <0.5 |
| | EMI suppression | | -- | -- | -- | <50 | -- | <30 | -- |
| | Power magnetics | | <0.4 | <0.2 | <0.2 | -- | <0.2 | <0.1 | -- |
| See this page for additional material data | | | 22/23 | 24/25 | 26/27 | 28 | 29/30 | 31 | 32 |

These tables provide an overview of the major magnetic properties of all the Fair-Rite Products Corp. ferrite materials. Measurements are made at room temperature, unless otherwise specified, using medium size toroidal cores. Products will generally comply with these material properties. However detailed ferrite component specifications are as listed in the catalog or as mutually agreed to with the customer for their specific application.

For Your Notes

Visit our website at:
www.fair-rite.com

Fair-Rite Products Corp. PO Box 288, One Commercial Row, Wallkill, NY 12589-0288

Phone: (888) FAIR RITE / (845) 895-2055 • Fax: (888) FERRITE / (845) 895-2629 • Web: www.fair-rite.com
(888) 324-7748 (888) 337-7483 E -mail: ferrites@fair-rite.com

Our highest frequency NiZn ferrite intended for broadband transformers, antennas and HF high Q inductor applications up to 100 MHz. This material is only supplied to customer-specific requirements and close consultation with our application staff is suggested.

Strong magnetic fields or excessive mechanical stresses may result in irreversible changes in permeability and losses.

68 Material Characteristics:

| Property | Unit | Symbol | Value |
|--|------------------|-----------------------|-----------------|
| Initial Permeability @ B < 10 gauss | | μ_i | 16 |
| Flux Density @ Field Strength | gauss oersted | B H | 2700 40 |
| Residual Flux Density | gauss | B_r | 1000 |
| Coercive Force | oersted | H_c | 7.0 |
| Loss Factor @ Frequency | 10^{-6} MHz | $\tan \delta / \mu_i$ | 500 100 |
| Temperature Coefficient of Initial Permeability (20 -70°C) | %/°C | | 0.10 |
| Curie Temperature | °C | T_c | >500 |
| Resistivity | Ω cm | ρ | 1×10^7 |

Complex Permeability vs. Frequency

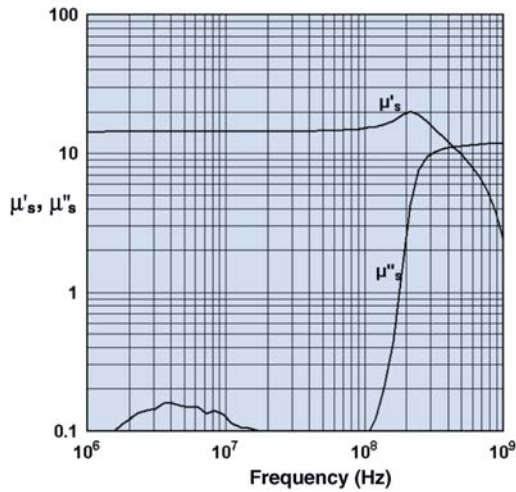

Measured on an 18/10/6mm toroid using the HP 4284A and the HP 4291A.

Initial Permeability vs. Temperature

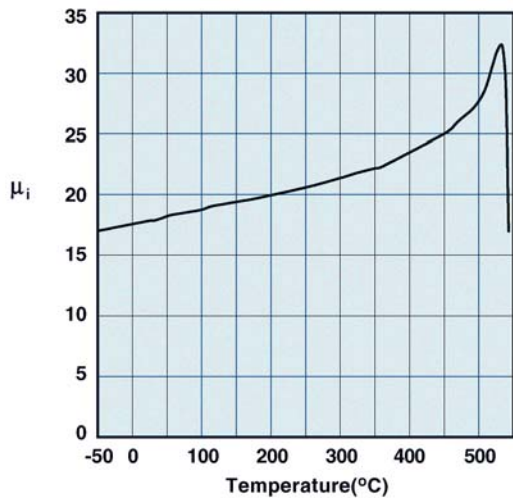

Measured on an 18/10/6mm toroid at 100 kHz.

Hysteresis Loop

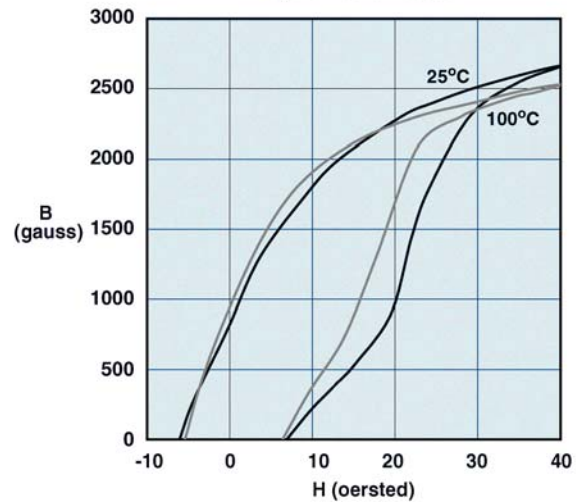

Measured on an 18/10/6mm toroid at 10 kHz.

A high frequency NiZn ferrite for the design of broadband transformers, antennas and HF, high Q inductor applications up to 50 MHz. Toroids, multi-aperture cores and antenna/RFID rods are available in this material.

Strong magnetic fields or excessive mechanical stresses may result in irreversible changes in permeability and losses.

67 Material Characteristics:

| Property | Unit | Symbol | Value |
|--|------------------|-----------------------|-----------------|
| Initial Permeability @ B < 10 gauss | | μ_i | 40 |
| Flux Density @ Field Strength | gauss oersted | B H | 2300 20 |
| Residual Flux Density | gauss | B_r | 800 |
| Coercive Force | oersted | H_c | 3.5 |
| Loss Factor @ Frequency | 10^{-6} MHz | $\tan \delta / \mu_i$ | 150 50 |
| Temperature Coefficient of Initial Permeability (20 -70°C) | %/°C | | 0.05 |
| Curie Temperature | °C | T_c | >475 |
| Resistivity | Ω cm | ρ | 1×10^7 |

Complex Permeability vs. Frequency

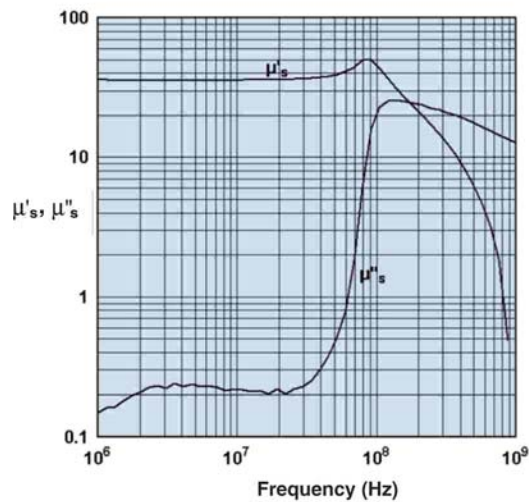

Measured on an 19/10/6mm toroid using the HP 4284A and the HP 4291A.

Initial Permeability vs. Temperature

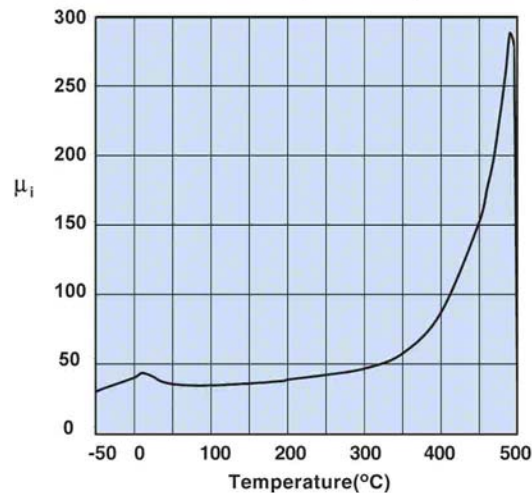

Measured on a 19/10/6mm toroid at 100 kHz.

Hysteresis Loop

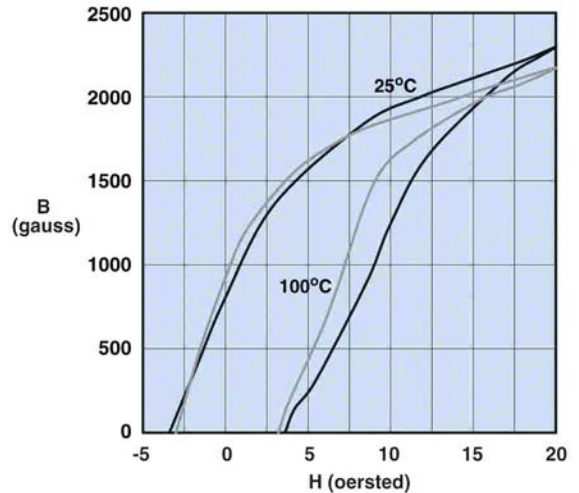

Measured on a 19/10/6mm toroid at 10 kHz.

A high frequency NiZn ferrite developed for a range of inductive applications up to 25 MHz. This material is also used in EMI applications for suppression of noise frequencies above 200 MHz.

EMI suppression beads, beads on leads, SM beads, wound beads, multi-aperture cores, round cable snap-its, rods, antenna/RFID rods, and toroids are all available in 61 material.

Strong magnetic fields or excessive mechanical stresses may result in irreversible changes in permeability and losses.

61 Material Characteristics:

| Property | Unit | Symbol | Value |
|--|------------------|-----------------------|-----------------|
| Initial Permeability @ B < 10 gauss | | μ_i | 125 |
| Flux Density @ Field Strength | gauss oersted | B H | 2350 15 |
| Residual Flux Density | gauss | B_r | 1200 |
| Coercive Force | oersted | H_c | 1.8 |
| Loss Factor @ Frequency | 10^{-6} MHz | $\tan \delta / \mu_i$ | 30 1.0 |
| Temperature Coefficient of Initial Permeability (20 -70°C) | %/°C | | 0.10 |
| Curie Temperature | °C | T_c | >300 |
| Resistivity | Ω cm | ρ | 1×10^8 |

Complex Permeability vs. Frequency

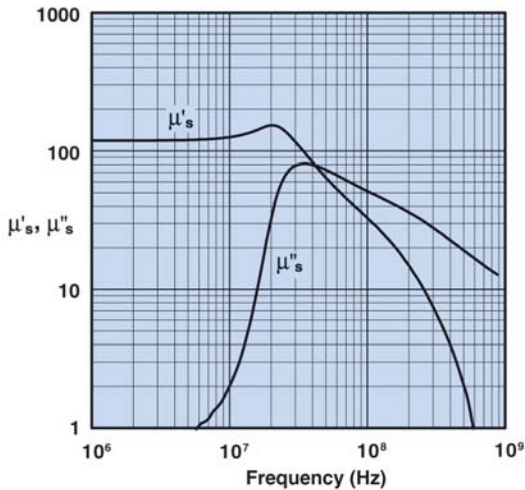

Measured on a 19/10/6mm toroid using the HP 4284A and the HP 4291A.

Percent of Original Impedance vs. Temperature

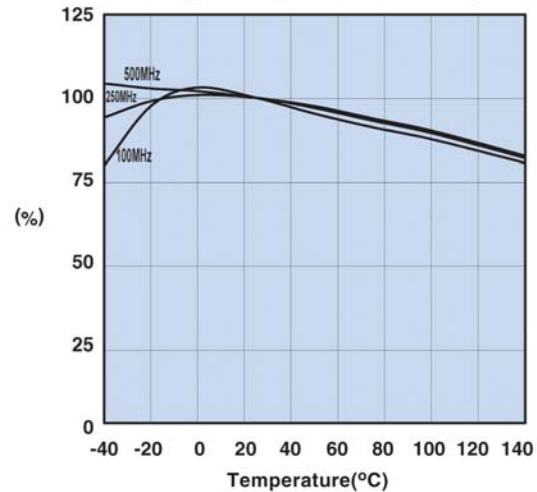

Measured on a 2661000301 using the HP4291A.

Initial Permeability vs. Temperature

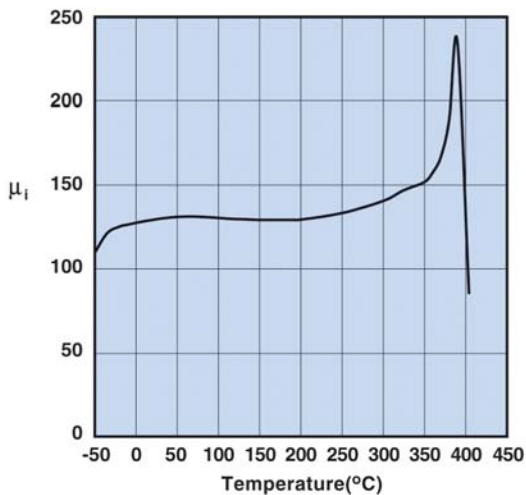

Measured on a 19/10/6mm toroid at 100 kHz.

Hysteresis Loop

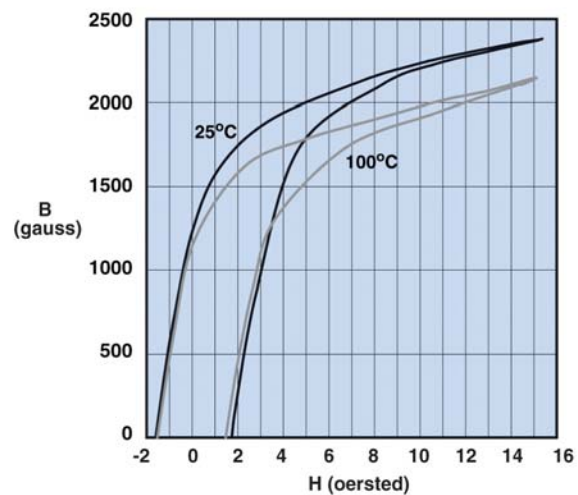

Measured on a 19/10/6mm toroid at 10 kHz.

A new high frequency NiZn ferrite material, that combines a high saturation flux density and a high Curie temperature.

SM beads, PC beads and a range of rod cores are available in this material.

52 Material Specifications:

| Property | Unit | Symbol | Value |
|--|------------------|---------------------|-----------------|
| Initial Permeability @ B < 10 gauss | | μ_i | 250 |
| Flux Density @ Field Strength | gauss oersted | B H | 4200 10 |
| Residual Flux Density | gauss | B_r | 2900 |
| Coercive Force | oersted | H_c | 0.60 |
| Loss Factor @ Frequency | 10^{-6} MHz | $\tan \delta/\mu_i$ | 45 1.0 |
| Temperature Coefficient of Initial Permeability (20 -70°C) | %/°C | | 1.0 |
| Curie Temperature | °C | T_c | >250 |
| Resistivity | Ω cm | ρ | 1×10^9 |

Complex Permeability vs. Frequency

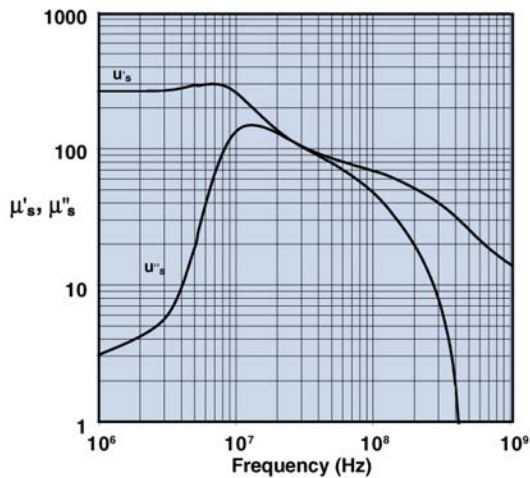

Measured on a 17/10/6mm toroid using the HP 4284A and the HP 4291A.

Flux Density vs. Temperature

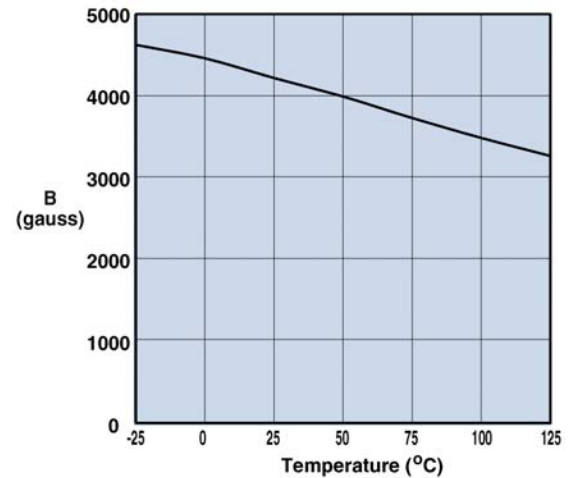

Measured on a 17/10/6mm toroid at 10kHz. and H=10 oersted.

Initial Permeability vs. Temperature

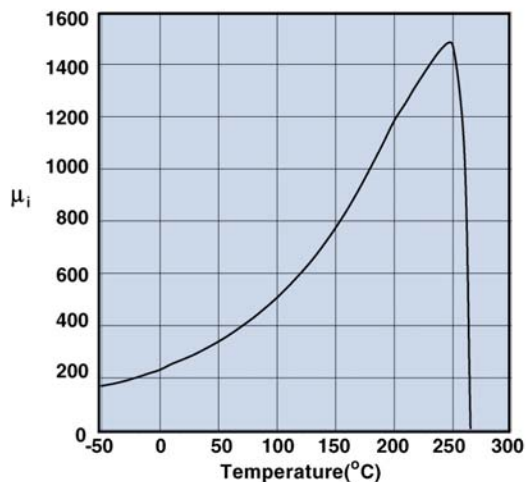

Measured on a 17/10/6mm toroid at 100kHz.

Hysteresis Loop

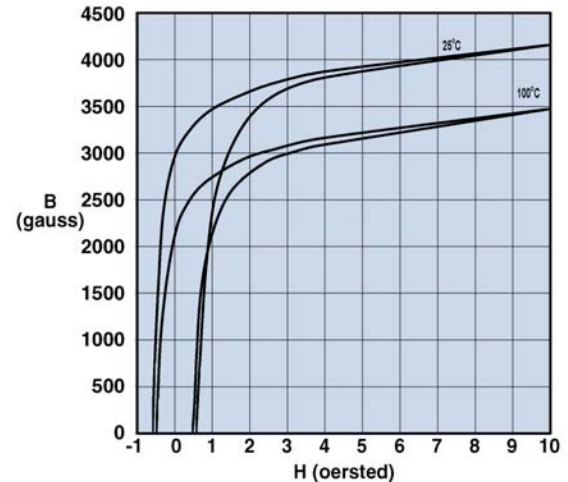

Measured on a 17/10/6mm toroid at 10kHz.

A NiZn ferrite developed for low loss inductive designs for frequencies up to 5.0 MHz.

This material is available as special order for customer specific applications.

51 Material Characteristics:

| Property | Unit | Symbol | Value |
|--|------------------|-----------------------|-----------------|
| Initial Permeability @ B < 10 gauss | | μ_i | 350 |
| Flux Density @ Field Strength | gauss oersted | B H | 3200 10 |
| Residual Flux Density | gauss | B_r | 1200 |
| Coercive Force | oersted | H_c | 0.60 |
| Loss Factor @ Frequency | 10^{-6} MHz | $\tan \delta / \mu_i$ | 40 1.0 |
| Temperature Coefficient of Initial Permeability (20 -70°C) | %/°C | | 0.8 |
| Curie Temperature | °C | T_c | >170 |
| Resistivity | Ω cm | ρ | 1×10^9 |

Complex Permeability vs. Frequency

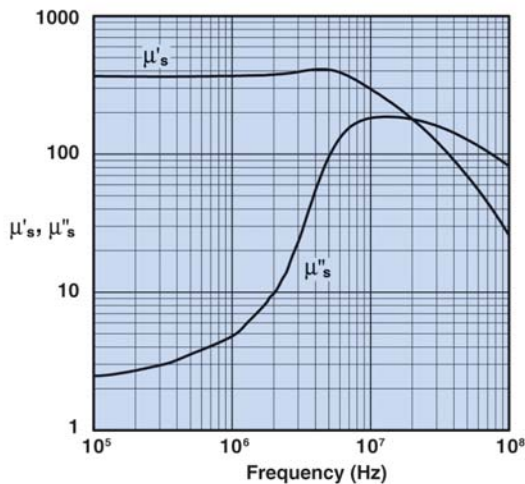

Measured on a 17/10/6mm toroid using the HP 4284A and the HP 4291A.

Incremental Permeability vs. H

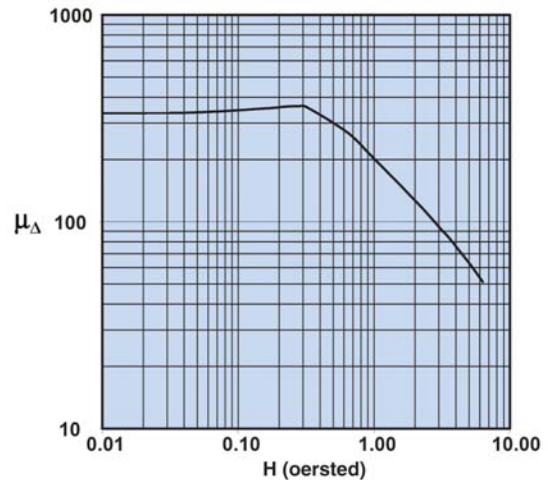

Initial Permeability vs. Temperature

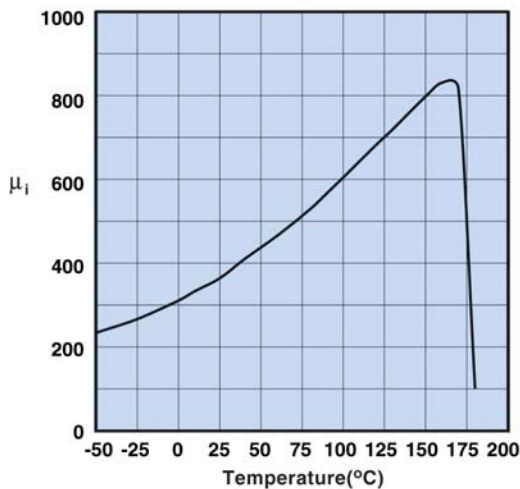

Measured on a 17/10/6mm toroid at 100 kHz.

Hysteresis Loop

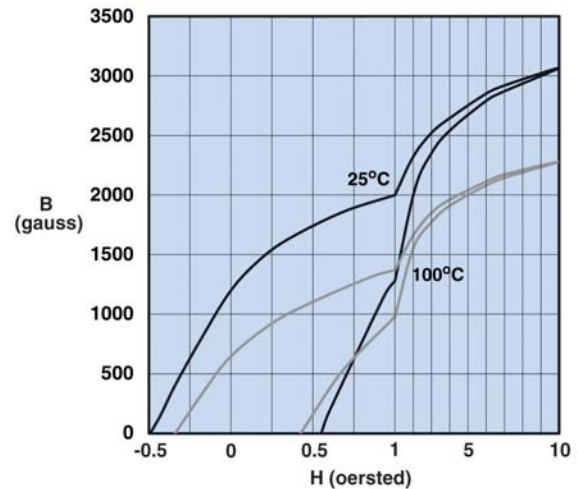

Measured on a 17/10/6mm toroid at 10 kHz.

A NiZn ferrite developed to combine a high suppression performance, from 30 MHz to 500 MHz, with a very high dc resistivity.

SM beads, PC beads, wound beads, round cable snap-its, and connector EMI suppression plates are all available in 44 material.

44 Material Characteristics:

| Property | Unit | Symbol | Value |
|--|------------------|-----------------------|-----------------|
| Initial Permeability @ B < 10 gauss | | μ_i | 500 |
| Flux Density @ Field Strength | gauss oersted | B H | 3000 10 |
| Residual Flux Density | gauss | B_r | 1100 |
| Coercive Force | oersted | H_c | 0.45 |
| Loss Factor @ Frequency | 10^{-6} MHz | $\tan \delta / \mu_i$ | 125 1.0 |
| Temperature Coefficient of Initial Permeability (20 -70°C) | %/°C | | 0.75 |
| Curie Temperature | °C | T_c | >160 |
| Resistivity | Ω cm | ρ | 1×10^9 |

Complex Permeability vs. Frequency

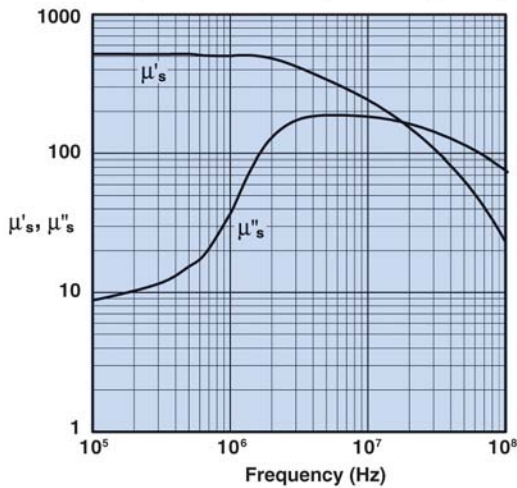

Measured on a 17/10/6mm toroid using the HP 4284A and the HP 4291A.

Percent of Original Impedance vs. Temperature

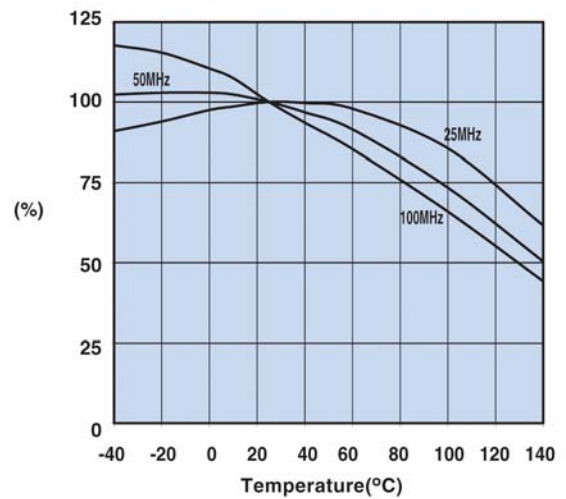

Measured on a 2644000301 using the HP4291A.

Initial Permeability vs. Temperature

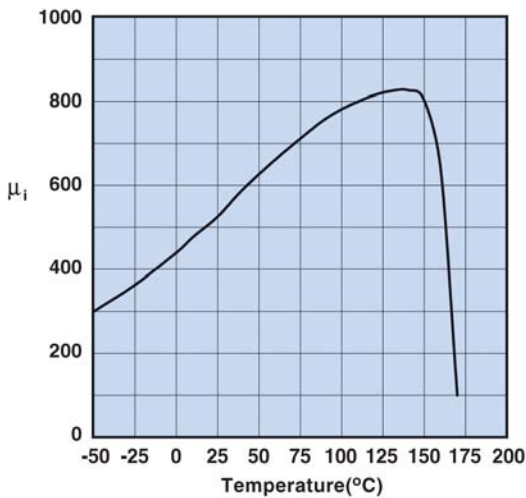

Measured on a 17/10/6mm toroid at 100 kHz.

Hysteresis Loop

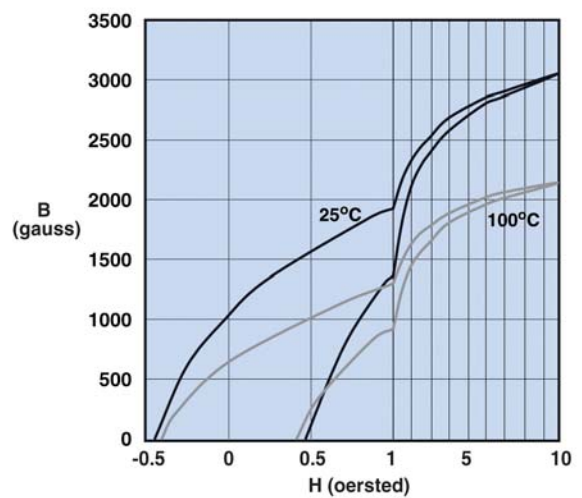

Measured on a 17/10/6mm toroid at 10 kHz.

Our latest material development is a MgZn ferrite intended for suppression applications. This material does not use nickel in its composition, hence it avoids potential environmental issues as well as reduces the cost of the material component of suppression parts. The suppression performance of this 46 material is similar to our widely used 43 material.

The new Fair-Rite grade 46 is supplied in the larger sizes of the round cable EMI suppression and snap-it cores.

46 Material Characteristics:

| Property | Unit | Symbol | Value |
|--|------------------|-----------------------|-----------------|
| Initial Permeability @ B < 10 gauss | | μ_i | 500 |
| Flux Density @ Field Strength | gauss oersted | B H | 3000 10 |
| Residual Flux Density | gauss | B_r | 1900 |
| Coercive Force | oersted | H_c | 0.40 |
| Loss Factor @ Frequency | 10^{-6} MHz | $\tan \delta / \mu_i$ | 60 0.1 |
| Temperature Coefficient of Initial Permeability (20 -70°C) | %/°C | | ----- |
| Curie Temperature | °C | T_c | >140 |
| Resistivity | Ω cm | ρ | 1×10^8 |

Complex Permeability vs. Frequency

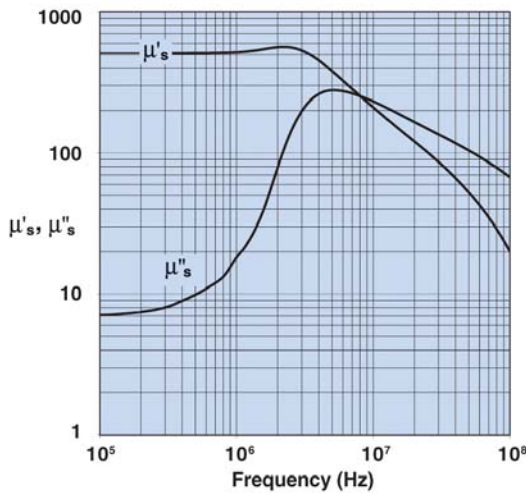

Measured on a 17/10/6mm toroid using the HP 4284A and the HP 4291A.

Percent of Original Impedance vs. Temperature

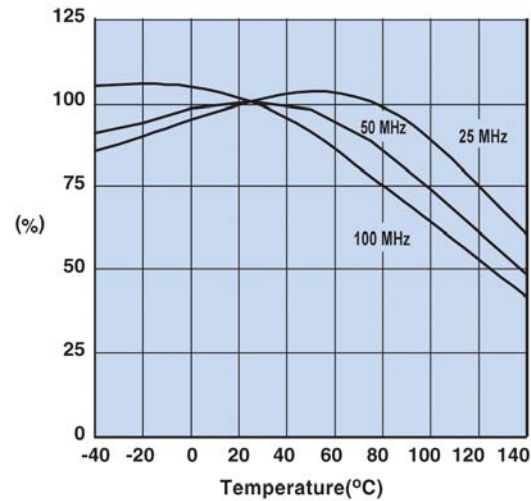

Measured on a 2646000301 using the HP4291A.

Initial Permeability vs. Temperature

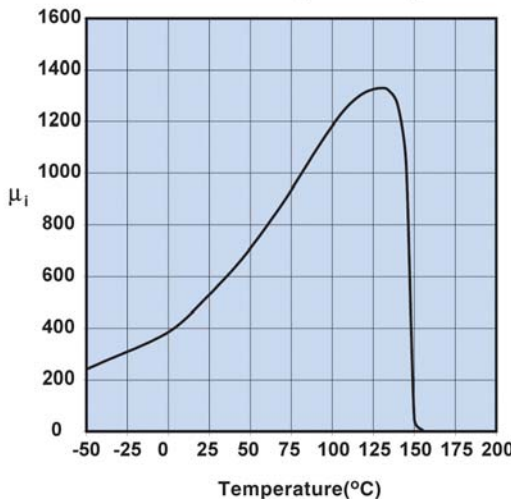

Measured on a 17/10/6mm toroid at 100 kHz.

Hysteresis Loop

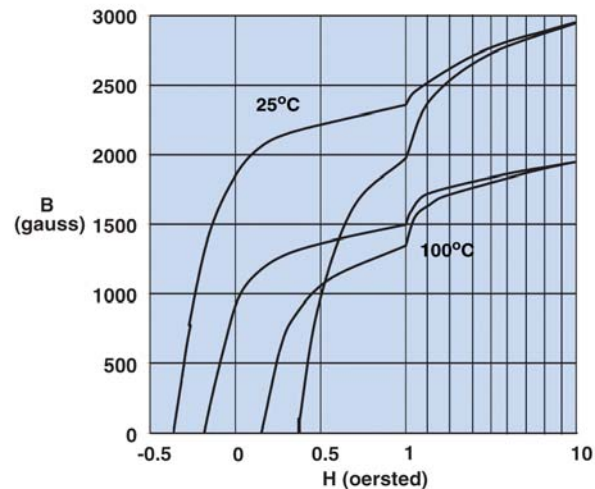

Measured on a 17/10/6mm toroid at 10 kHz.

33 Material



An economical MnZn ferrite designed for use in open circuit applications for frequencies up to 3.0 MHz.

Rods are available in 33 material.

Not recommended for new designs.

33 Material Characteristics:

| Property | Unit | Symbol | Value |
|--|------------------|-----------------------|-----------------|
| Initial Permeability @ B < 10 gauss | | μ_i | 600 |
| Flux Density @ Field Strength | gauss oersted | B H | 2800 5 |
| Residual Flux Density | gauss | B_r | 1200 |
| Coercive Force | oersted | H_c | 0.60 |
| Loss Factor @ Frequency | 10^{-6} MHz | $\tan \delta / \mu_i$ | 25 0.2 |
| Temperature Coefficient of Initial Permeability (20 -70°C) | %/°C | | 0.10 |
| Curie Temperature | °C | T_c | >150 |
| Resistivity | Ω cm | ρ | 1×10^2 |

Complex Permeability vs. Frequency

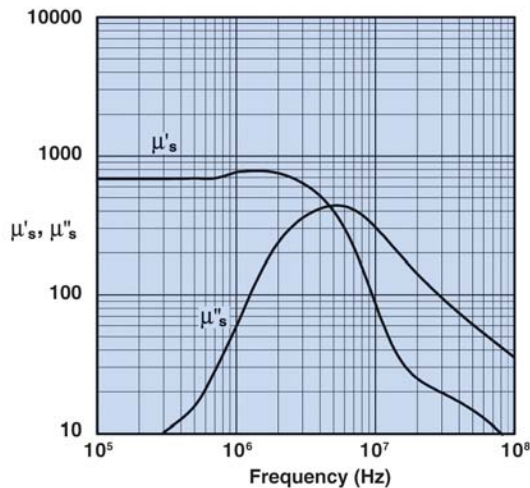

Measured on a 17/10/6mm toroid using the HP 4284A and, the HP 4291A.

Initial Permeability vs. Temperature

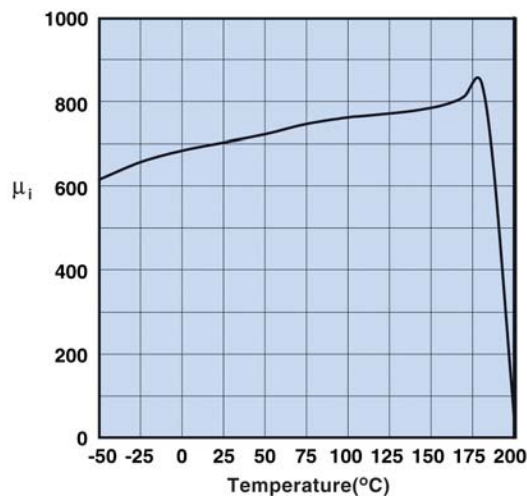

Measured on a 17/10/6mm toroid at 100 kHz.

Hysteresis Loop

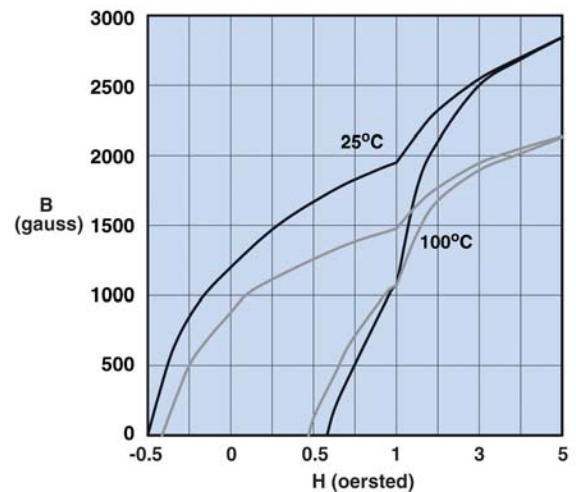

Measured on a 17/10/6mm toroid at 10 kHz.

Fair-Rite Products Corp. PO Box 288, One Commercial Row, Wallkill, NY 12589-0288

Phone: (888) FAIR RITE / (845) 895-2055 • Fax: (888) FERRITE / (845) 895-2629 • Web: www.fair-rite.com
 (888) 324-7748 (888) 337-7483 E -mail: ferrites@fair-rite.com

This NiZn is our most popular ferrite for suppression of conducted EMI from 20 MHz to 250 MHz. This material is also used for inductive applications such as high frequency common-mode chokes.

EMI suppression beads, beads on leads, SM beads, multi-aperture cores, round cable EMI suppression cores, round cable snap-its, flat cable EMI suppression cores, flat cable snap-its, miscellaneous suppression cores, bobbins, and toroids are all available in 43 material.

43 Material Characteristics:

| Property | Unit | Symbol | Value |
|--|------------------|-----------------------|-----------------|
| Initial Permeability @ B < 10 gauss | | μ_i | 800 |
| Flux Density @ Field Strength | gauss oersted | B H | 2900 10 |
| Residual Flux Density | gauss | B_r | 1300 |
| Coercive Force | oersted | H_c | 0.45 |
| Loss Factor @ Frequency | 10^{-6} MHz | $\tan \delta / \mu_i$ | 250 1.0 |
| Temperature Coefficient of Initial Permeability (20 -70°C) | %/°C | | 1.25 |
| Curie Temperature | °C | T_c | >130 |
| Resistivity | Ω cm | ρ | 1×10^5 |

Complex Permeability vs. Frequency

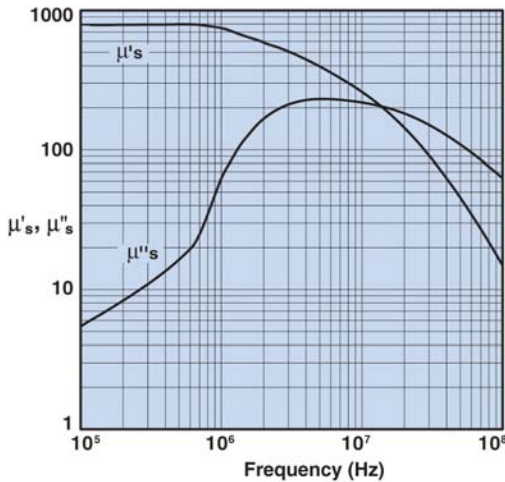

Measured on a 17/10/6mm toroid using the HP 4284A and the HP 4291A.

Percent of Original Impedance vs. Temperature

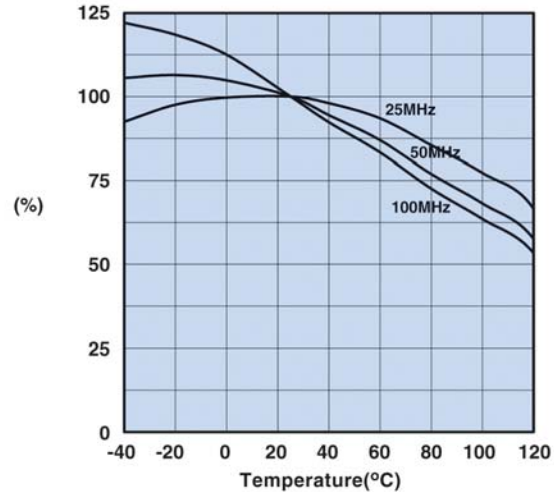

Measured on a 2643000301 using the HP4291A.

Initial Permeability vs. Temperature

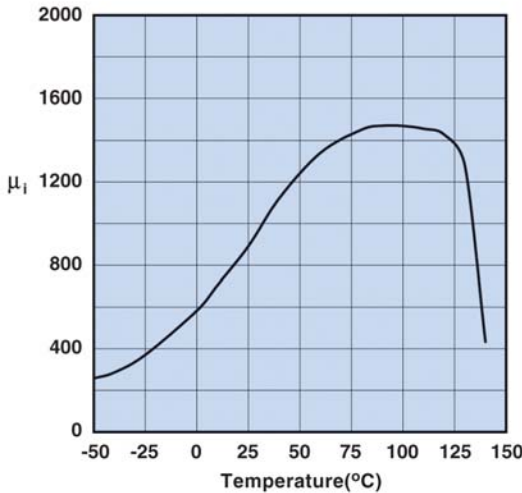

Measured on a 17/10/6mm toroid at 100 kHz.

Hysteresis Loop

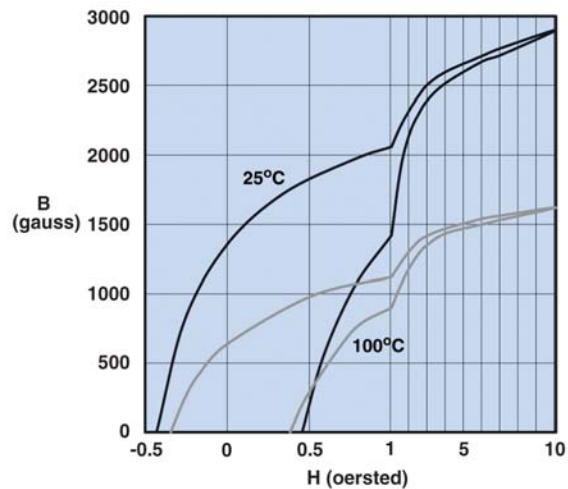

Measured on a 17/10/6mm toroid at 10 kHz.

31 Material



A MnZn ferrite designed specifically for EMI suppression applications from as low as 1 MHz up to 500 MHz. This material does not have the dimensional resonance limitations associated with conventional MnZn ferrite materials.

Round cable EMI suppression cores, round cable snap-its, flat cable EMI suppression cores, and flat cable snap-its are all available in 31 material.

31 Material Characteristics:

| Property | Unit | Symbol | Value |
|--|------------------|-----------------------|-----------------|
| Initial Permeability @ B < 10 gauss | | μ_i | 1500 |
| Flux Density @ Field Strength | gauss oersted | B H | 3400 5 |
| Residual Flux Density | gauss | B_r | 2500 |
| Coercive Force | oersted | H_c | 0.35 |
| Loss Factor @ Frequency | 10^{-6} MHz | $\tan \delta / \mu_i$ | 20 0.1 |
| Temperature Coefficient of Initial Permeability (20 -70°C) | %/°C | | 1.6 |
| Curie Temperature | °C | T_c | >130 |
| Resistivity | Ω cm | ρ | 3×10^9 |

Complex Permeability vs. Frequency

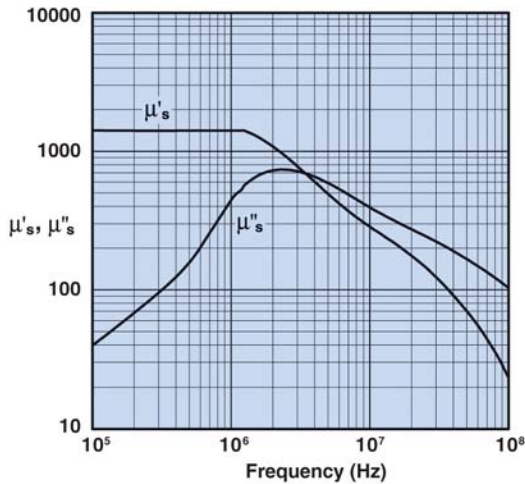

Measured on a 17/10/6mm toroid at 25°C using the HP 4284A and the HP 4291A.

Percent of Original Impedance vs. Temperature

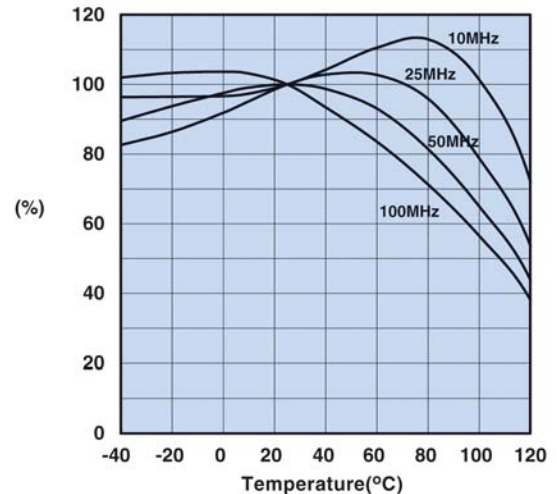

Measured on a 2631000301 using the HP4291A.

Initial Permeability vs. Temperature

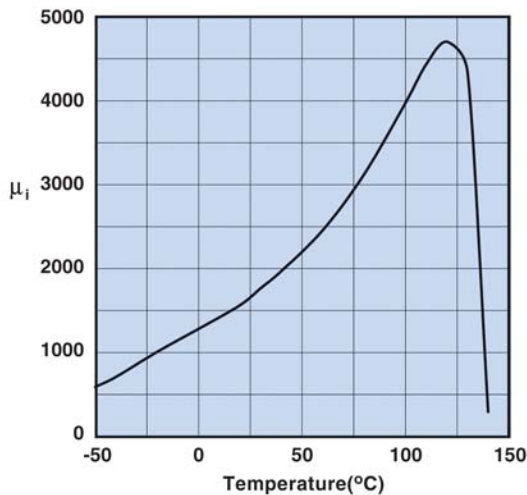

Measured on a 17/10/6mm toroid at 100 kHz.

Hysteresis Loop

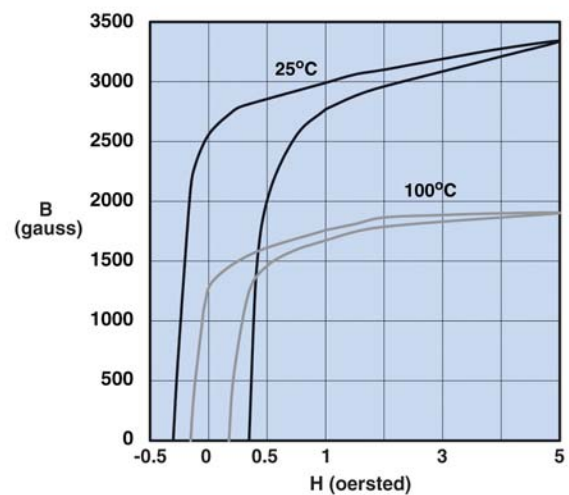

Measured on a 17/10/6mm toroid at 10 kHz.

Fair-Rite Products Corp. PO Box 288, One Commercial Row, Wallkill, NY 12589-0288

Phone: (888) FAIR RITE / (845) 895-2055 • Fax: (888) FERRITE / (845) 895-2629 • Web: www.fair-rite.com
(888) 324-7748 (888) 337-7483 E -mail: ferrites@fair-rite.com

A new high frequency material for power applications up to 750 kHz.

This MnZn power ferrite is available in customer specific core designs.

This material is available as special order for customer specific applications.

79 Material Characteristics:

| Property | Unit | Symbol | Value |
|--|------------------|-----------------------|-----------------|
| Initial Permeability @ B < 10 gauss | | μ_i | 1400 |
| Flux Density @ Field Strength | gauss oersted | B H | 4700 5 |
| Residual Flux Density | gauss | B_r | 1700 |
| Coercive Force | oersted | H_c | 0.40 |
| Loss Factor @ Frequency | 10^{-6} MHz | $\tan \delta / \mu_i$ | 4.0 0.1 |
| Temperature Coefficient of Initial Permeability (20 -70°C) | %/°C | | 0.6 |
| Curie Temperature | °C | T_c | >225 |
| Resistivity | Ω cm | ρ | 2×10^2 |

Complex Permeability vs. Frequency

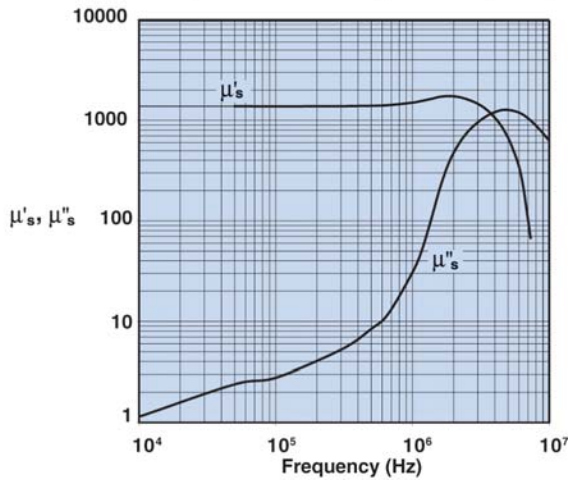

Measured on an 18/10/6mm toroid using the HP 4284A and the HP 4291A.

Incremental Permeability vs. H

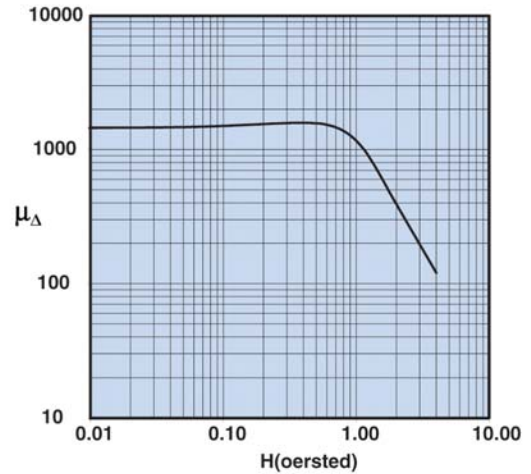

Initial Permeability vs. Temperature

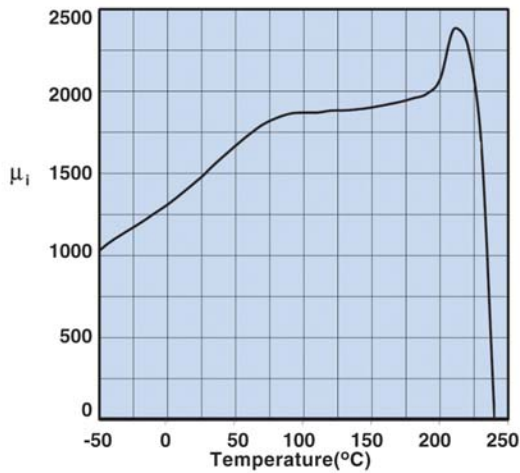

Measured on an 18/10/6mm toroid at 100 kHz.

Hysteresis Loop

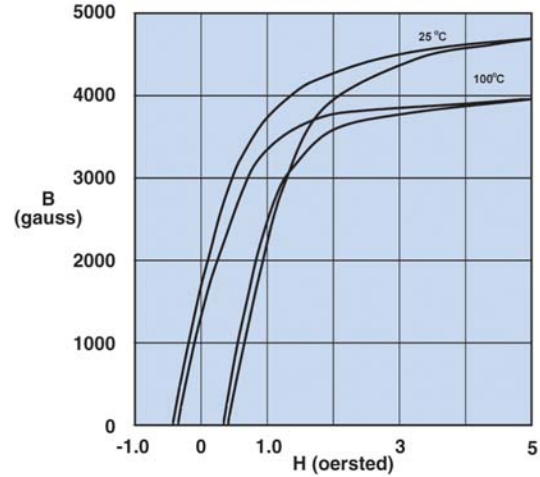

Measured on an 18/10/6mm toroid at 10 kHz.

Amplitude Permeability vs. Flux Density

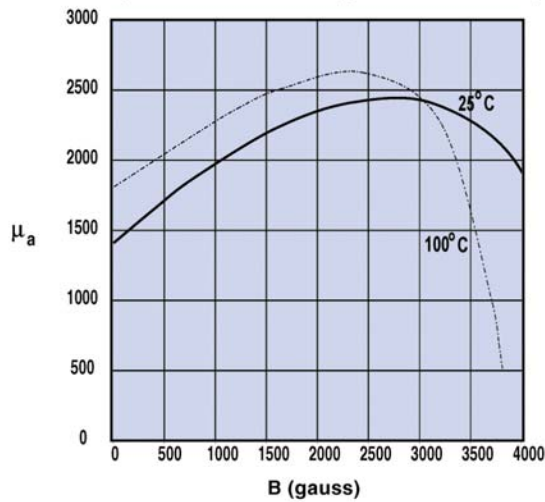

Measured on an 18/10/6mm toroid at 10 kHz.

Power Loss Density vs. Flux Density

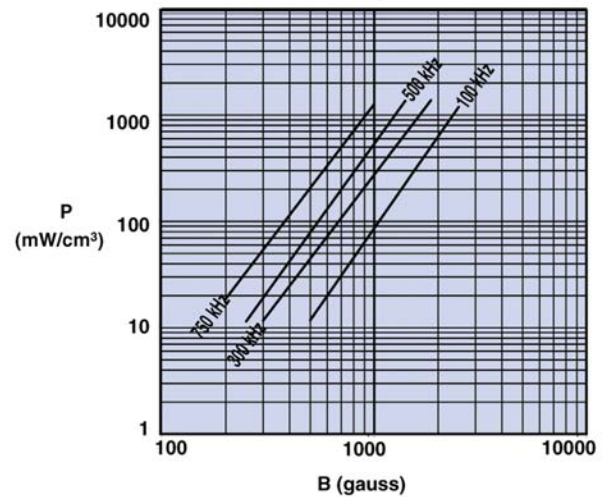

Measured on an 18/10/6mm toroid using the Clarke Hess 258 VAW at 100°C

Power Loss Density vs. Temperature

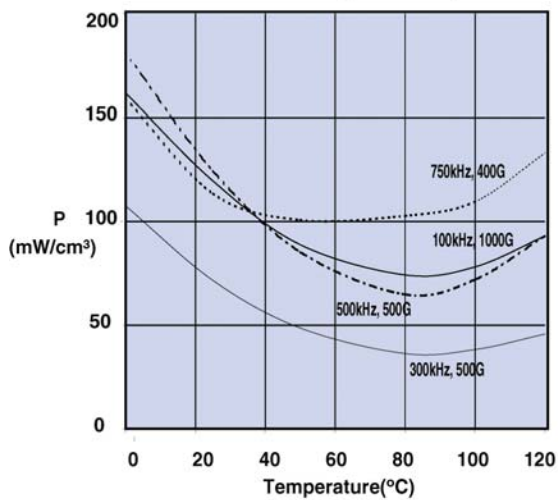

Measured on an 18/10/6mm toroid using the Clarke Hess 258 VAW.

Flux Density vs. Temperature

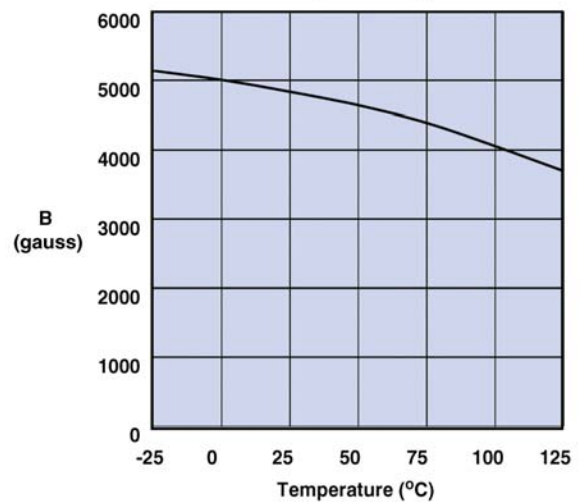

Measured on an 18/10/6mm toroid at 10 kHz. and H=5 oersted.

A MnZn ferrite for use in a wide range of high and low flux density inductive designs for frequencies up to 100 kHz.

Pot cores, E&I cores, U cores, rods, toroids, and bobbins are all available in 77 material.

77 Material Characteristics:

| Property | Unit | Symbol | Value |
|--|------------------|-----------------------|-----------------|
| Initial Permeability @ B < 10 gauss | | μ_i | 2000 |
| Flux Density @ Field Strength | gauss oersted | B H | 4900 5 |
| Residual Flux Density | gauss | B_r | 1800 |
| Coercive Force | oersted | H_c | 0.30 |
| Loss Factor @ Frequency | 10^{-6} MHz | $\tan \delta / \mu_i$ | 15 0.1 |
| Temperature Coefficient of Initial Permeability (20 -70°C) | %/°C | | 0.7 |
| Curie Temperature | °C | T_c | >200 |
| Resistivity | Ω cm | ρ | 1×10^2 |

Complex Permeability vs. Frequency

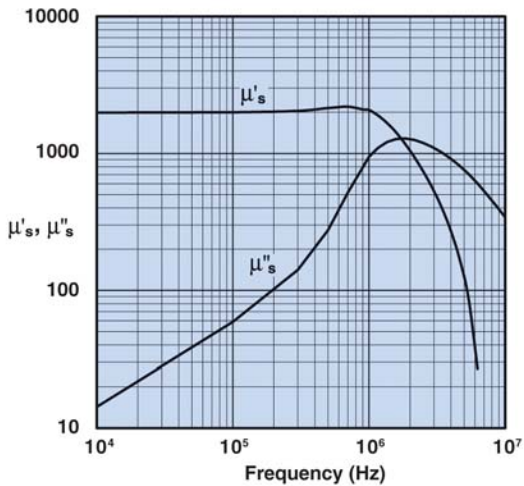

Measured on an 18/10/6mm toroid using the HP 4284A and the HP 4291A.

Incremental Permeability vs. H

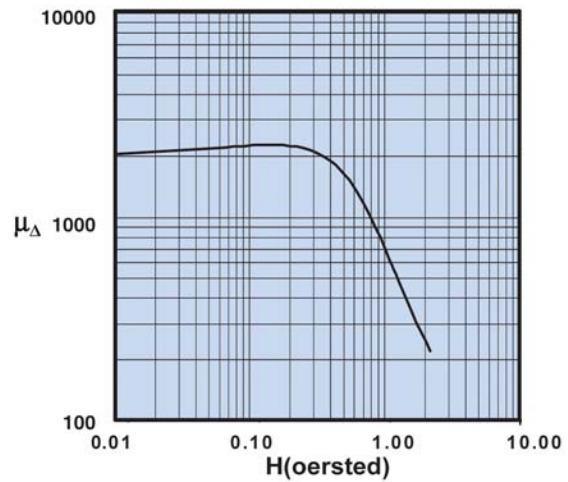

Initial Permeability vs. Temperature

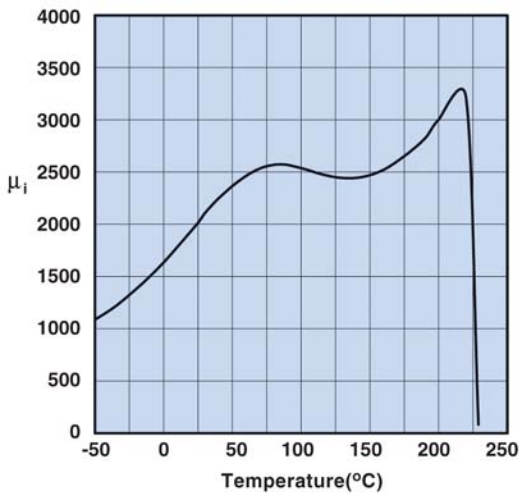

Measured on an 18/10/6mm toroid at 100 kHz.

Hysteresis Loop

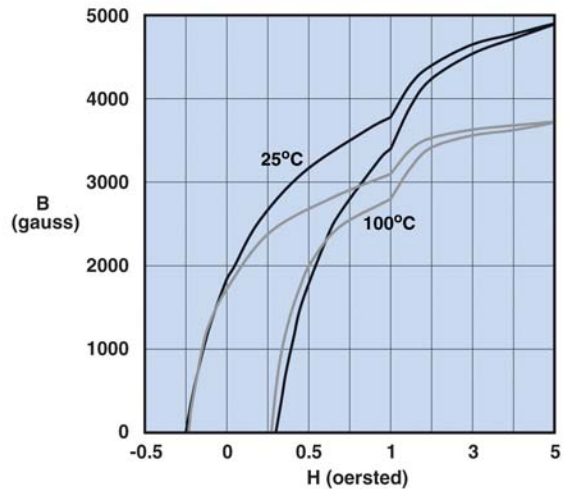

Measured on an 18/10/6mm toroid at 10 kHz.

Amplitude Permeability vs. Flux Density

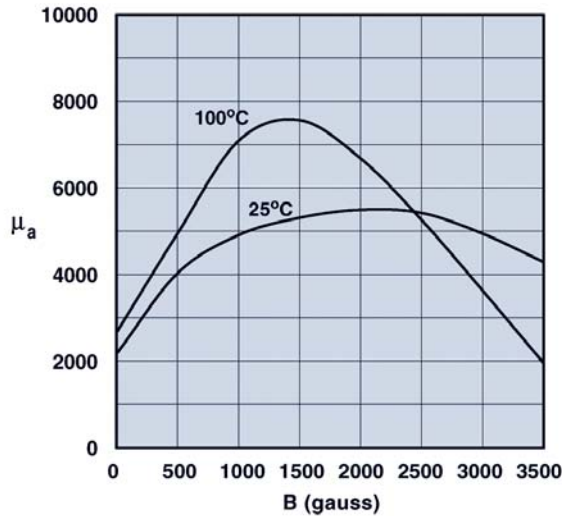

Measured on an 18/10/6mm toroid at 10 kHz.

Power Loss Density vs. Flux Density

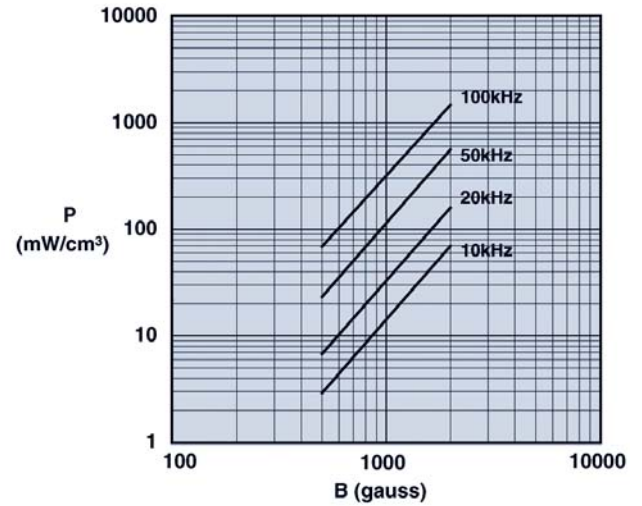

Measured on an 18/10/6mm toroid using the Clarke Hess 258 VAW at 100°C

Power Loss Density vs. Temperature

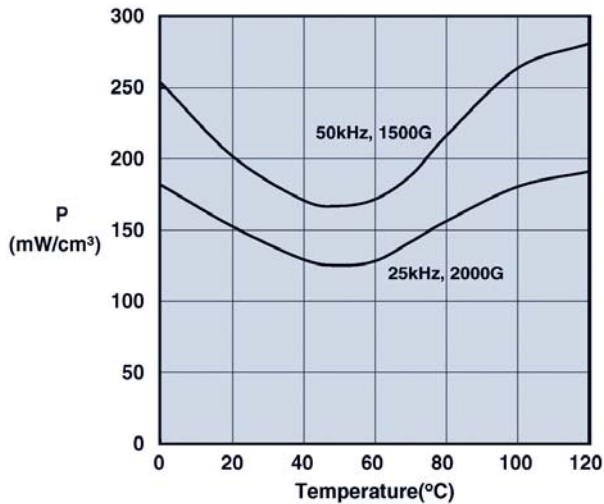

Measured on an 18/10/6mm toroid using the Clarke Hess 258 VAW.

Flux Density vs. Temperature

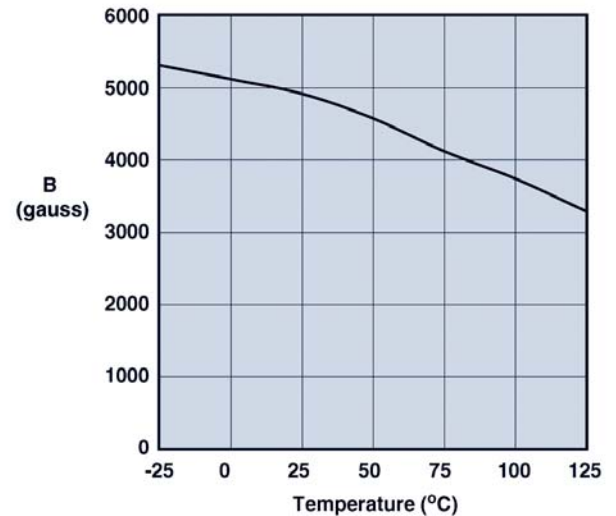

Measured on an 18/10/6mm toroid at 10 kHz and H=5 oersted.

97 Material



A low loss MnZn ferrite material for power applications up to 400 kHz.
 New type 97 Material is a low loss/higher frequency power material. It features minimal power loss at 100°C at moderate flux densities for operation below 400 kHz.

This material is available as special order for customer specific applications.

97 Material Characteristics

| Property | Unit | Symbol | Value |
|---|------------------|--------------------|------------|
| Initial Permeability @ B < 10gauss | | μ_i | 2000 |
| Flux Density @ Field Strength | gauss oersted | B H | 5000 5 |
| Residual Flux Density | gauss | B_r | 1500 |
| Coercive Force | oersted | H_c | 0.16 |
| Loss Factor @ Frequency | 10^{-6} MHz | $\tan\delta/\mu_i$ | 3.5 0.1 |
| Temperature Coefficient of Initial Permeability (20 - 70°C) | % / °C | | 1.4 |
| Curie Temperature | °C | T_c | > 220 |
| Resistivity | ohm-cm | ρ | 200 |

Complex Permeability vs. Frequency

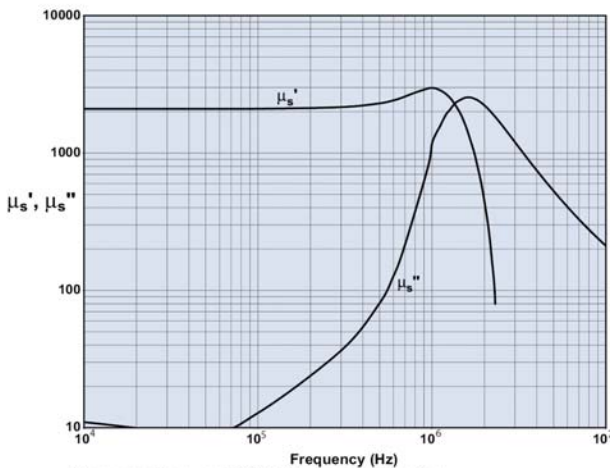

Measured on an 18/10/6mm toroid using HP 4284A and HP4291A.

Incremental Permeability vs. H

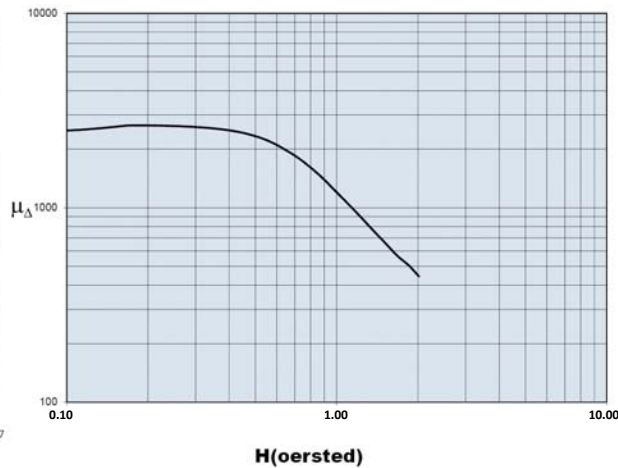

Initial Permeability vs. Temperature

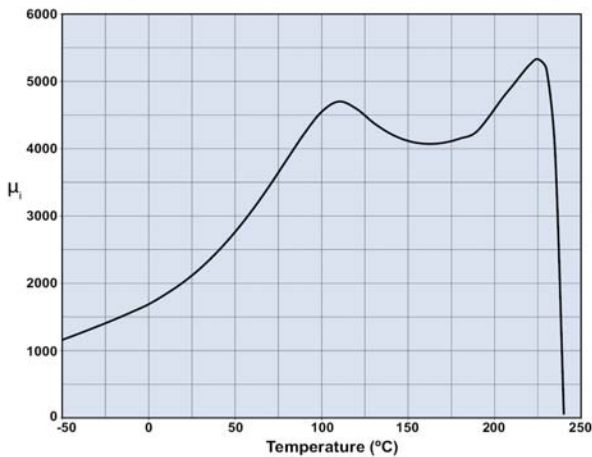

Measured on an 18/10/6mm toroid at 10kHz.

Hysteresis Loop

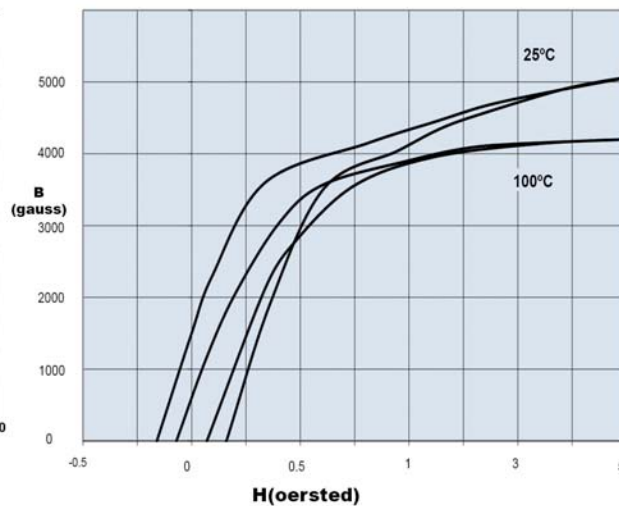

Measured on an 18/10/6mm toroid at 10kHz.

Fair-Rite Products Corp. PO Box 288, One Commercial Row, Wallkill, NY 12589-0288

A low loss MnZn ferrite material for power applications up to 400kHz.

Amplitude Permeability vs. Flux Density

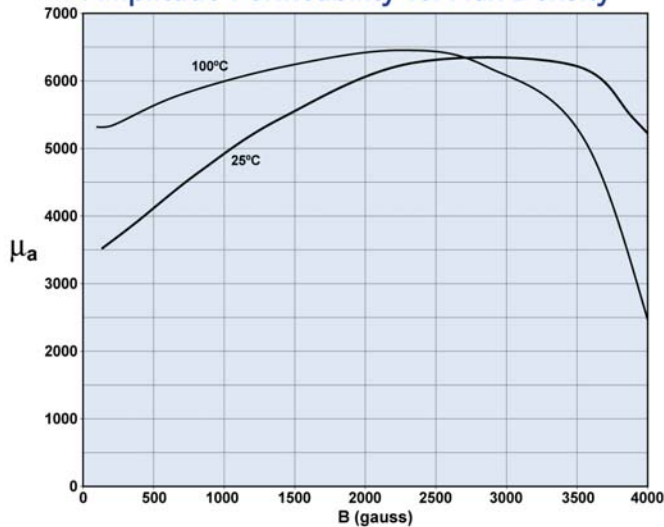

Measured on an 18/10/6mm toroid at 10kHz.

Power Loss Density vs. Flux Density

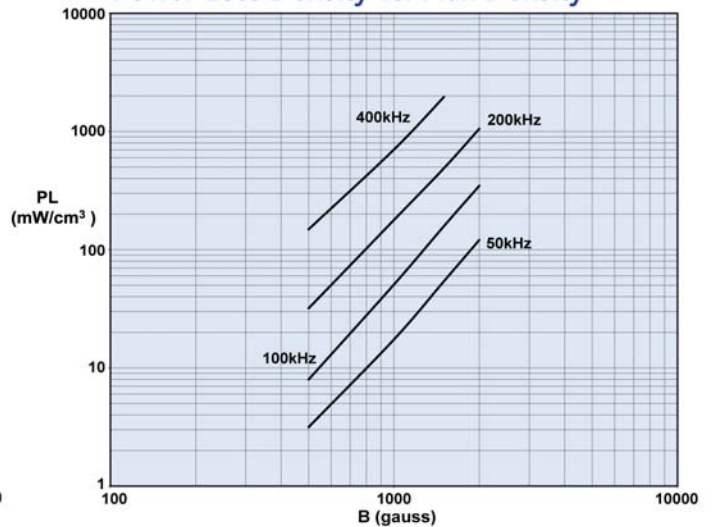

Measured on an 18/10/6mm toroid using the Clarke Hess 258 VAW at 100°C.

Power Loss Density vs. Temperature

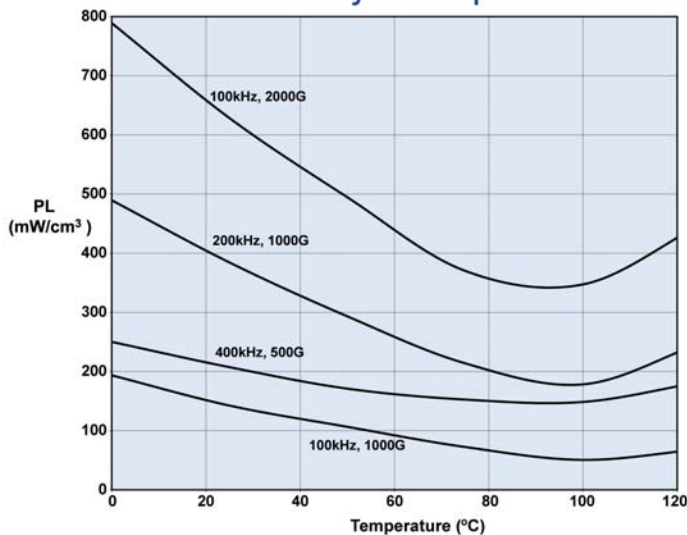

Measured on an 18/10/6mm toroid using the Clarke Hess 258 VAW.

Flux Density vs. Temperature

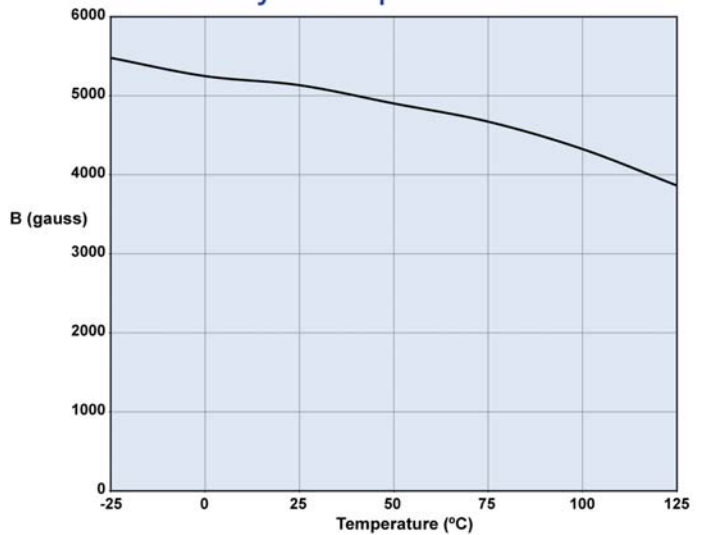

Measured on an 18/10/6mm toroid at 10kHz and H=5 oersted.

A MnZn ferrite specifically designed for power applications for frequencies up to 200 kHz.

RFID rods, toroids, U cores, and E&I cores are all available in 78 material.

78 Material Characteristics:

| Property | Unit | Symbol | Value |
|--|------------------|-----------------------|--------------------|
| Initial Permeability @ B < 10 gauss | | μ_i | 2300 |
| Flux Density @ Field Strength | gauss oersted | B H | 4800 5 |
| Residual Flux Density | gauss | B_r | 1500 |
| Coercive Force | oersted | H_c | 0.20 |
| Loss Factor @ Frequency | 10^{-6} MHz | $\tan \delta / \mu_i$ | 4.5 0.1 |
| Temperature Coefficient of Initial Permeability (20 -70°C) | %/°C | | 1.0 |
| Curie Temperature | °C | T_c | >200 |
| Resistivity | Ω cm | ρ | 2×10^{-2} |

Complex Permeability vs. Frequency

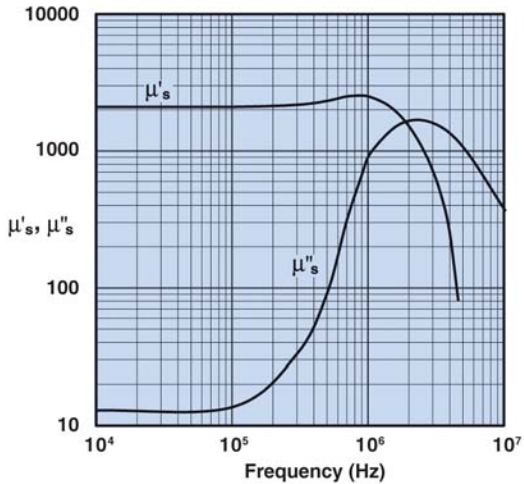

Measured on an 18/10/6mm toroid using the HP 4284A and the HP 4291A.

Incremental Permeability vs. H

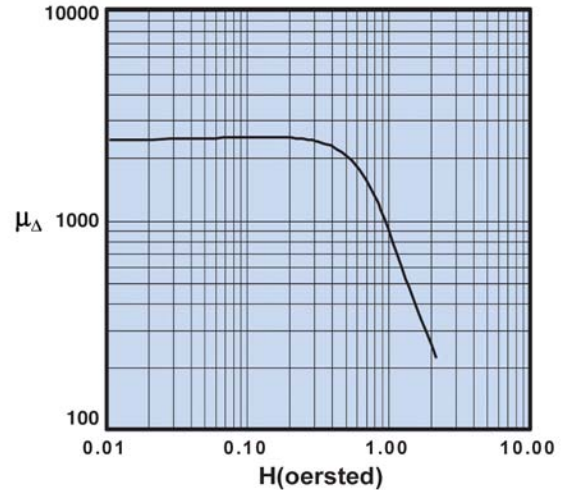

Initial Permeability vs. Temperature

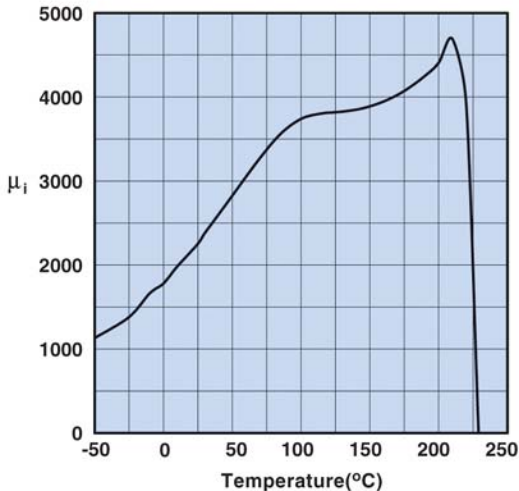

Measured on an 18/10/6mm toroid at 100 kHz.

Hysteresis Loop

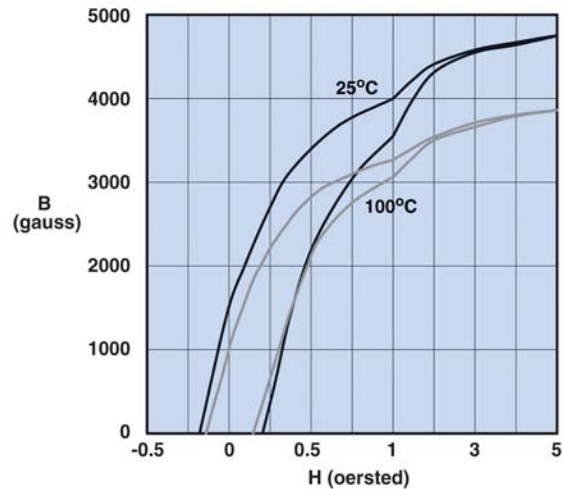

Measured on an 18/10/6mm toroid at 10 kHz.

Amplitude Permeability vs. Flux Density

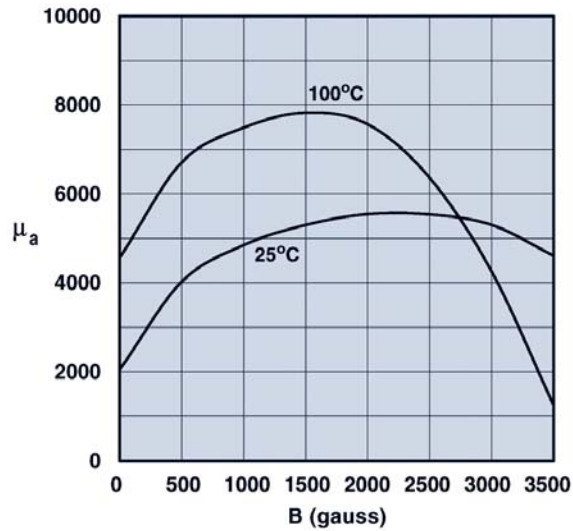

Measured on an 18/10/6mm toroid at 10 kHz.

Power Loss Density vs. Flux Density

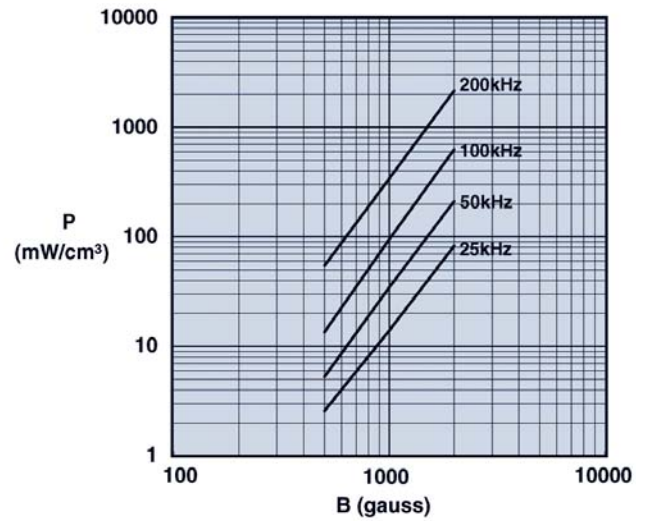

Measured on an 18/10/6mm toroid using the Clarke Hess 258 VAW at 100°C

Power Loss Density vs. Temperature

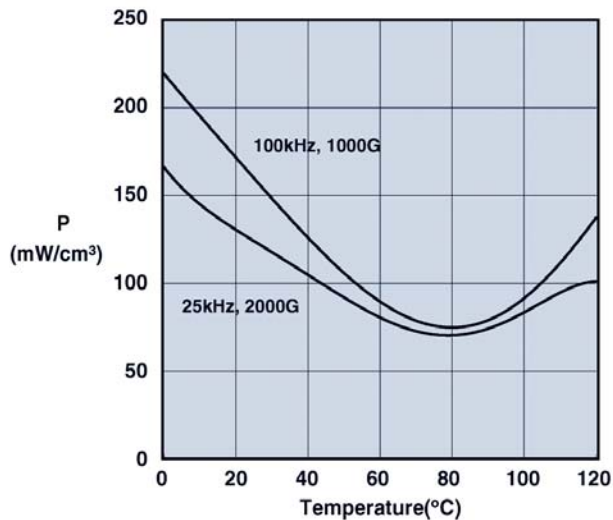

Measured on an 18/10/6mm toroid using the Clarke Hess 258 VAW.

Flux Density vs. Temperature

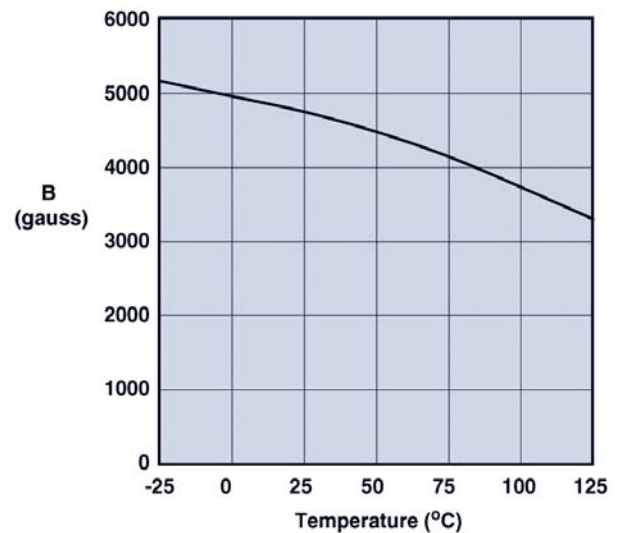

Measured on an 18/10/6 mm toroid at 10 kHz and H=5 oersted.

A low loss MnZn ferrite material for power applications up to 200 kHz.

New type 98 Material is an improved version of Fair-Rite's 78 Material, this material supplies, lower power loss at 100°C at moderate flux densities for operation below 200 kHz.

Shapes available in 98 material are Toroids, U Cores, E & I Cores, Pot Cores, RM, PQ, ETD, EFD, EP, EER.

98 Material Characteristics

| Property | Unit | Symbol | Value |
|---|------------------|--------------------|------------|
| Initial Permeability @ B < 10gauss | | μ_i | 2400 |
| Flux Density @ Field Strength | gauss oersted | B H | 5000 5 |
| Residual Flux Density | gauss | B_r | 1800 |
| Coercive Force | oersted | H_c | 0.17 |
| Loss Factor @ Frequency | 10^{-6} MHz | $\tan\delta/\mu_i$ | 3.5 0.1 |
| Temperature Coefficient of Initial Permeability (20 - 70°C) | % / °C | | 1.5 |
| Curie Temperature | °C | T_c | > 215 |
| Resistivity | ohm-cm | ρ | 200 |

Complex Permeability vs. Frequency

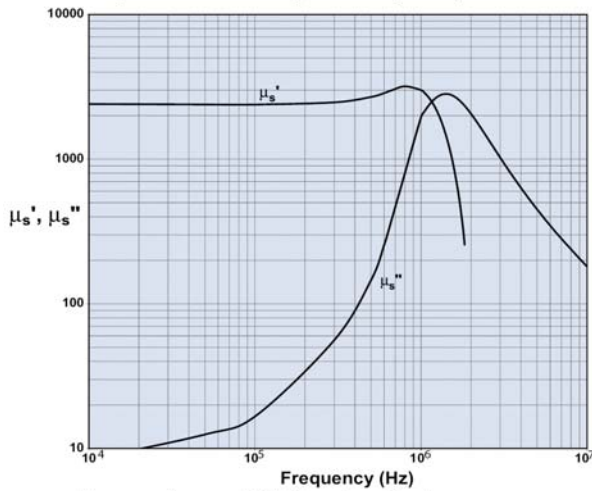

Measured on an 18/10/6mm toroid using HP 4284A and HP4291A.

Incremental Permeability vs. H



Initial Permeability vs. Temperature

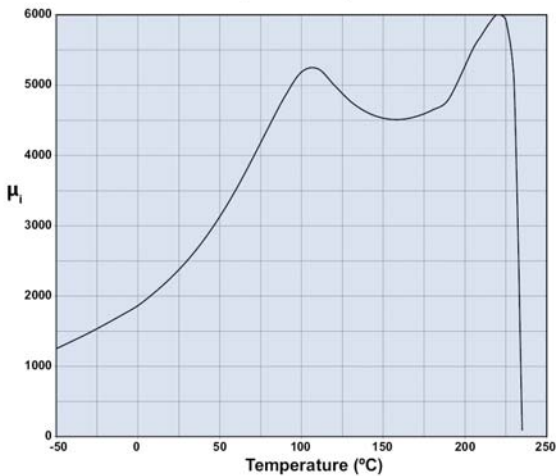

Measured on an 18/10/6mm toroid at 10kHz.

Hysteresis Loop

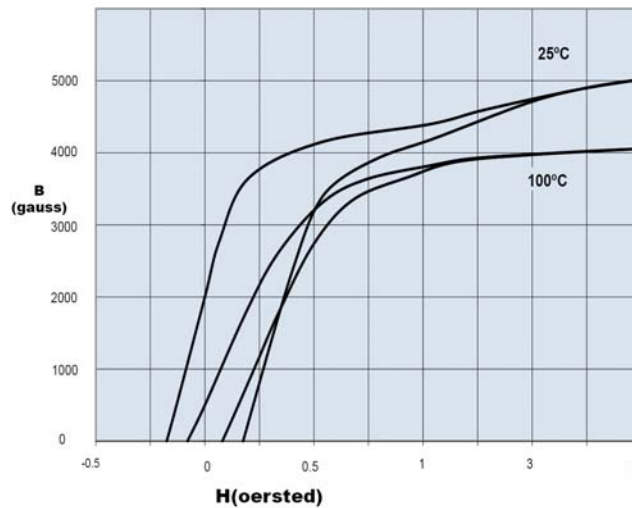

Measured on an 18/10/6mm toroid at 10kHz.

A low loss MnZn ferrite material for power applications up to 200kHz.

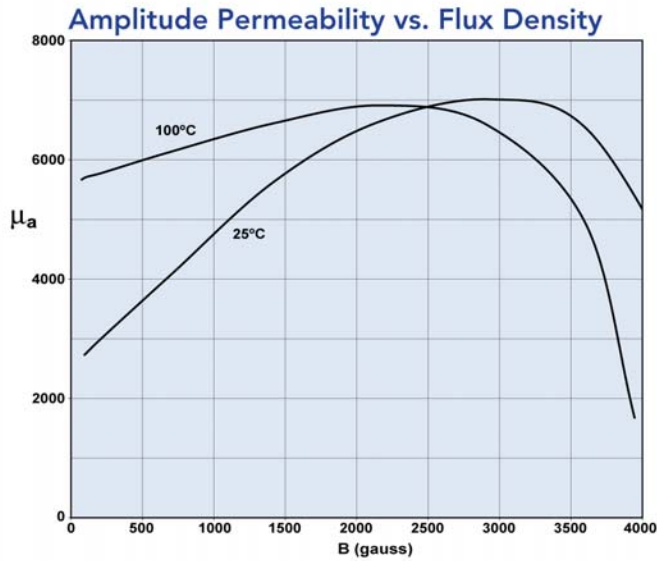

Measured on an 18/10/6mm toroid at 10kHz.

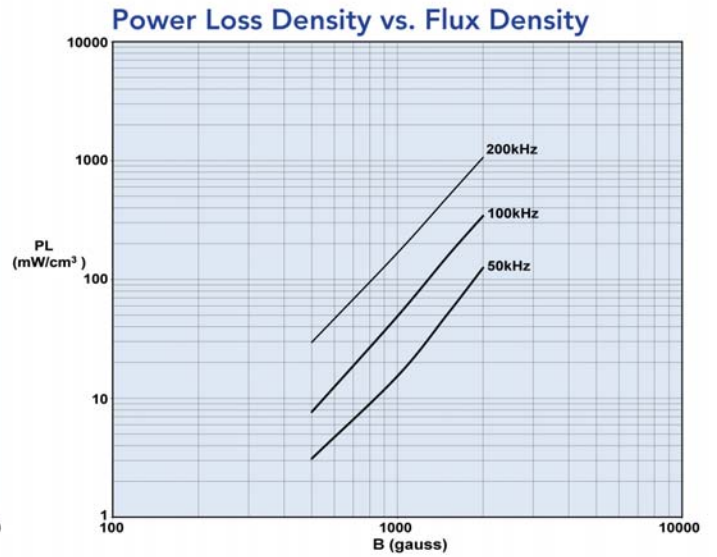

Measured on an 18/10/6mm toroid using the Clarke Hess 258 VAW at 100°C.

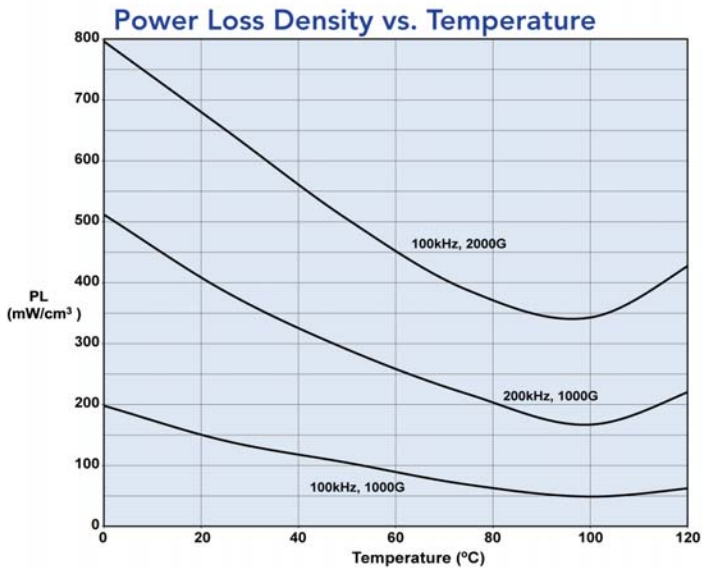

Measured on an 18/10/6mm toroid using the Clarke Hess 258 VAW.

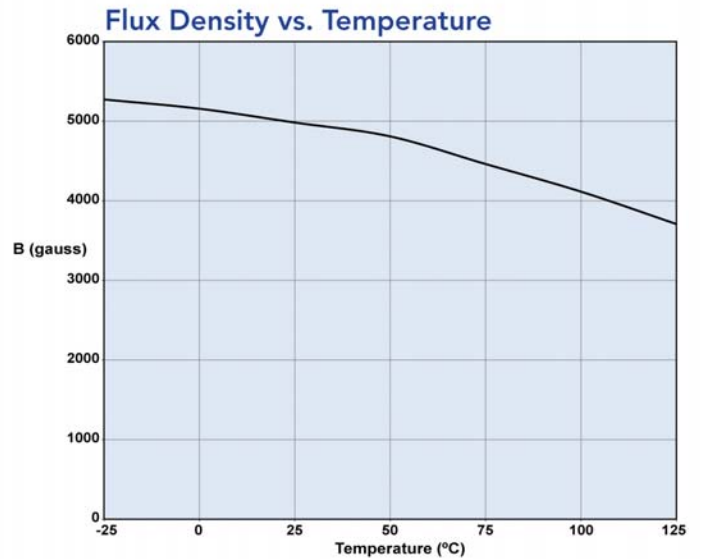

Measured on an 18/10/6mm toroid at 10kHz and H=5 oersted.

A MnZn ferrite, supplied only in small cores, to suppress conducted EMI frequencies below 50 MHz.

EMI suppression beads, beads on leads, SM beads, and multi-aperture cores are all available in 73 material.

73 Material Characteristics:

| Property | Unit | Symbol | Value |
|--|------------------|-----------------------|-----------------|
| Initial Permeability @ B < 10 gauss | | μ_i | 2500 |
| Flux Density @ Field Strength | gauss oersted | B H | 3900 5 |
| Residual Flux Density | gauss | B_r | 1500 |
| Coercive Force | oersted | H_c | 0.24 |
| Loss Factor @ Frequency | 10^{-6} MHz | $\tan \delta / \mu_i$ | 10 0.1 |
| Temperature Coefficient of Initial Permeability (20 -70°C) | %/°C | | 0.65 |
| Curie Temperature | °C | T_c | >160 |
| Resistivity | Ω cm | ρ | 1×10^2 |

Complex Permeability vs. Frequency

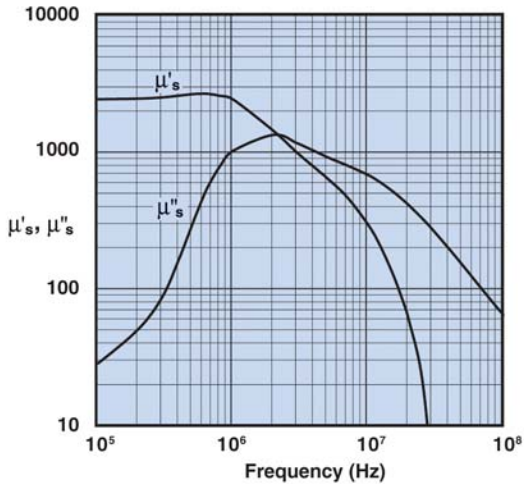

Measured on a 2673000301 bead using the HP 4284A and the HP 4291A.

Percent of Original Impedance vs. Temperature

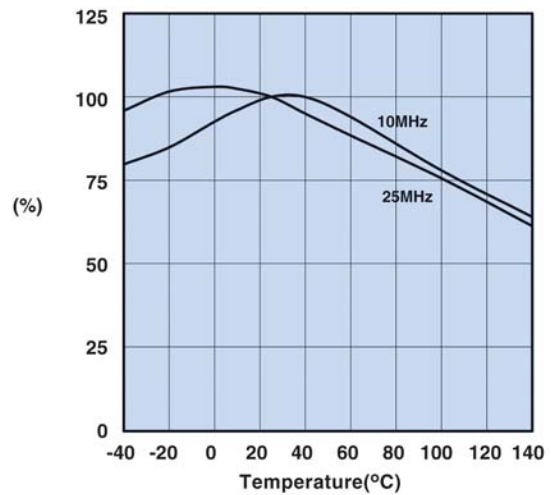

Measured on a 2673000301 using the HP4291A.

Initial Permeability vs. Temperature

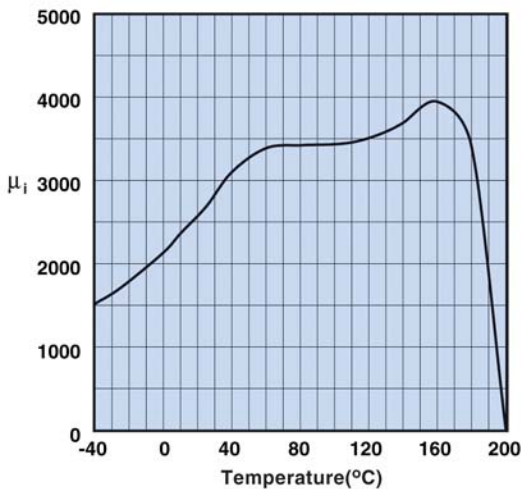

Measured on a 17/10/6mm toroid at 10 kHz.

Hysteresis Loop

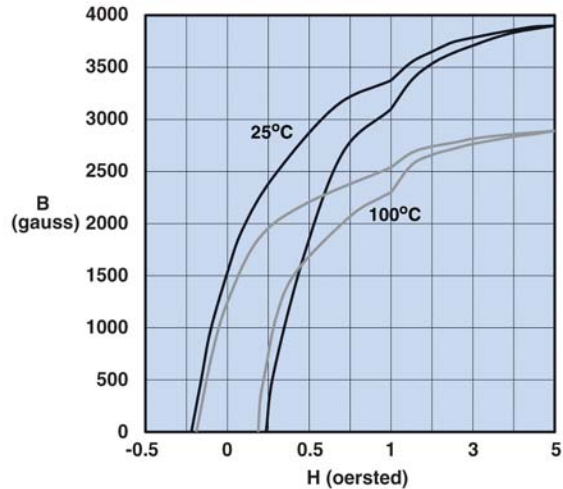

Measured on a 17/10/6mm toroid at 10 kHz.

A low loss MnZn ferrite material for power applications up to 200 kHz with low temperature variation. New type 95 Material is a low loss power material, which features less power loss over temperature (25-120°C) at moderate flux densities for operation below 200 kHz.

Shapes available in 95 material are Toroids, U cores, Pot Cores, RM, PQ, EFD, EP.

95 Material Characteristics

| Property | Unit | Symbol | Value |
|---|------------------|--------------------|------------|
| Initial Permeability @ B < 10gauss | | μ_i | 3000 |
| Flux Density @ Field Strength | gauss oersted | B H | 5000 5 |
| Residual Flux Density | gauss | B_r | 800 |
| Coercive Force | oersted | H_c | 0.13 |
| Loss Factor @ Frequency | 10^{-6} MHz | $\tan\delta/\mu_i$ | 3.0 0.1 |
| Temperature Coefficient of Initial Permeability (20 - 70°C) | % / °C | | 0.4 |
| Curie Temperature | °C | T_c | > 220 |
| Resistivity | ohm-cm | ρ | 200 |

Complex Permeability vs. Frequency

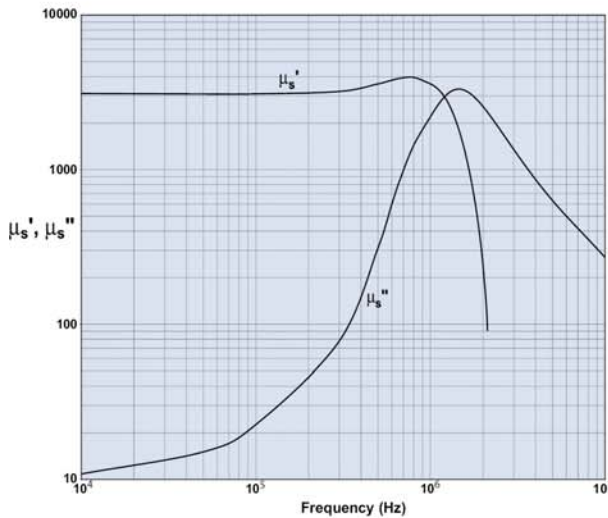

Measured on an 18/10/6mm toroid using HP 4284A and HP4291A.

Incremental Permeability vs. H



Initial Permeability vs. Temperature

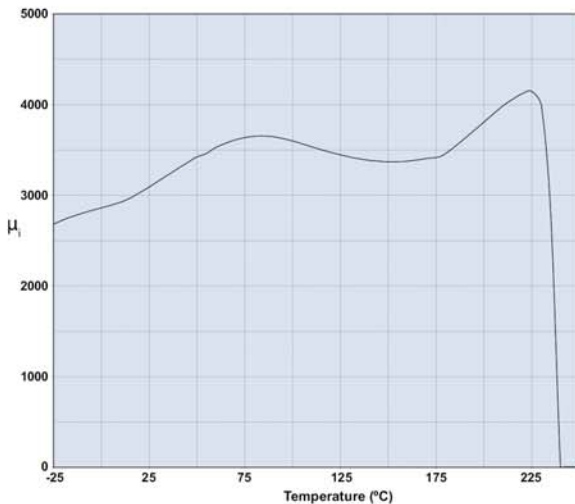

Measured on an 18/10/6mm toroid at 10kHz.

Hysteresis Loop

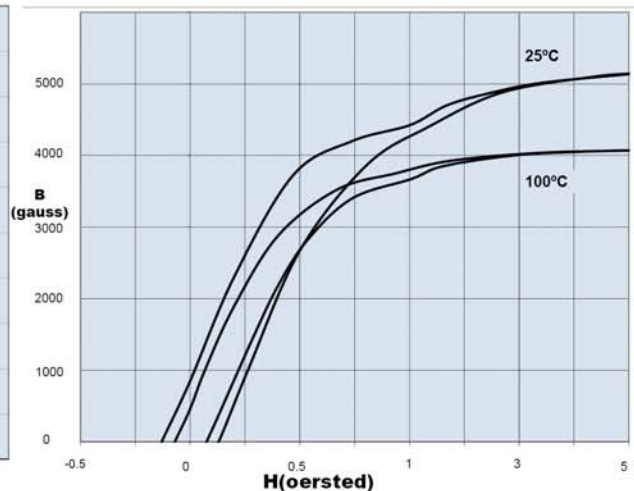

Measured on an 18/10/6mm toroid at 10kHz.

A low loss MnZn ferrite material for power applications up to 200kHz with low temperature variation.

Amplitude Permeability vs. Flux Density

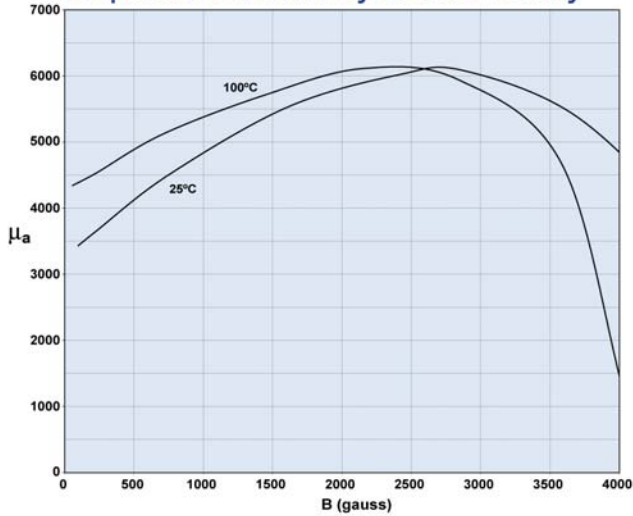

Measured on an 18/10/6mm toroid at 10kHz.

Power Loss Density vs. Flux Density

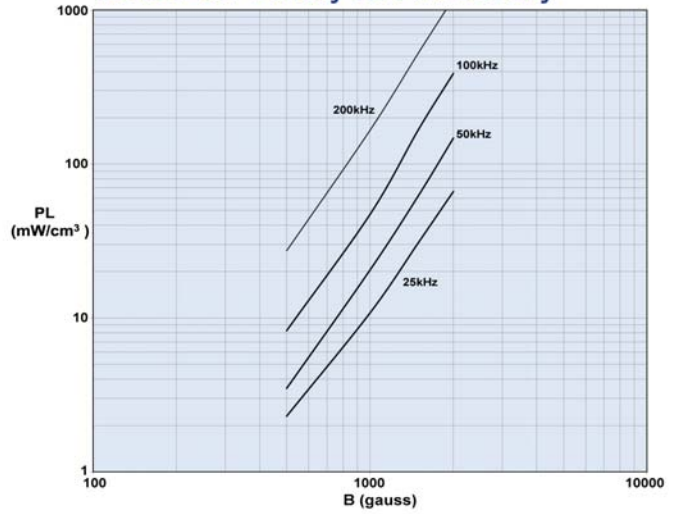

Measured on an 18/10/6mm toroid using the Clarke Hess 258 VAW at 100°C.

Power Loss Density vs. Temperature

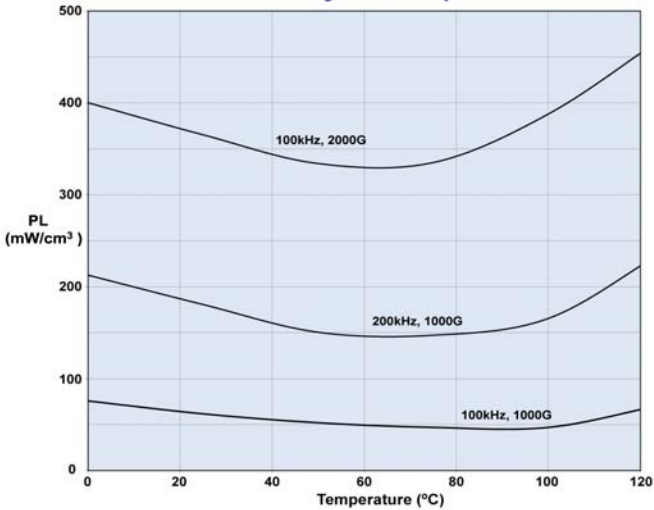

Measured on an 18/10/6mm toroid using the Clarke Hess 258 VAW at 100°C.

Flux Density vs. Temperature

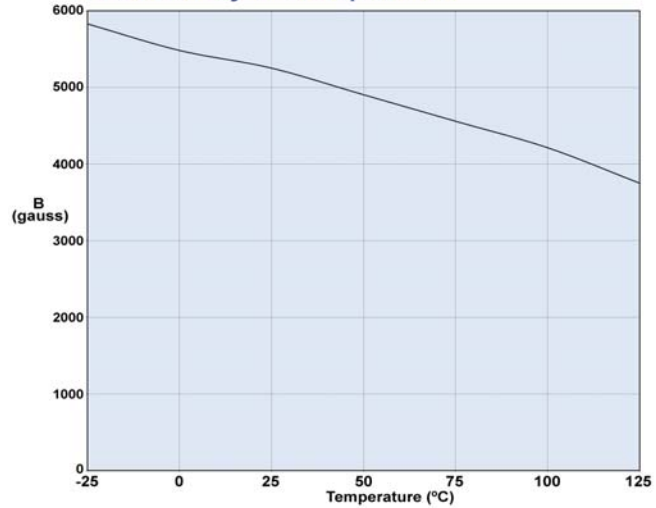

Measured on an 18/10/6mm toroid at 10kHz and H=5 oersted.

A high permeability MnZn ferrite intended for a range of broadband and pulse transformer applications and common-mode inductor designs.

Toroidal cores are available in 75 material.

75 Material Characteristics:

| Property | Unit | Symbol | Value |
|--|------------------|-----------------------|-----------------|
| Initial Permeability @ B < 10 gauss | | μ_i | 5000 |
| Flux Density @ Field Strength | gauss oersted | B H | 4300 5 |
| Residual Flux Density | gauss | B_r | 1400 |
| Coercive Force | oersted | H_c | 0.16 |
| Loss Factor @ Frequency | 10^{-6} MHz | $\tan \delta / \mu_i$ | 15 0.1 |
| Temperature Coefficient of Initial Permeability (20 -70°C) | %/°C | | 0.6 |
| Curie Temperature | °C | T_c | >140 |
| Resistivity | Ω cm | ρ | 3×10^2 |

Complex Permeability vs. Frequency

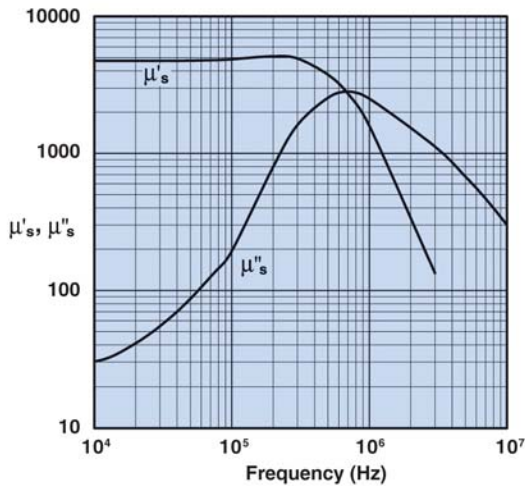

Measured on a 17/10/6mm toroid using the HP 4284A and the HP 4291A.

Power Loss Density vs. Flux Density

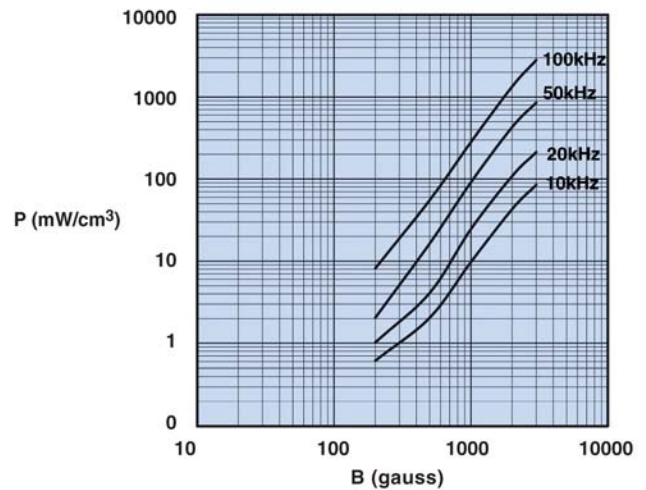

Measured on a 17/10/6mm toroid using the Clarke Hess 258 VAW at 100°C.

Initial Permeability vs. Temperature

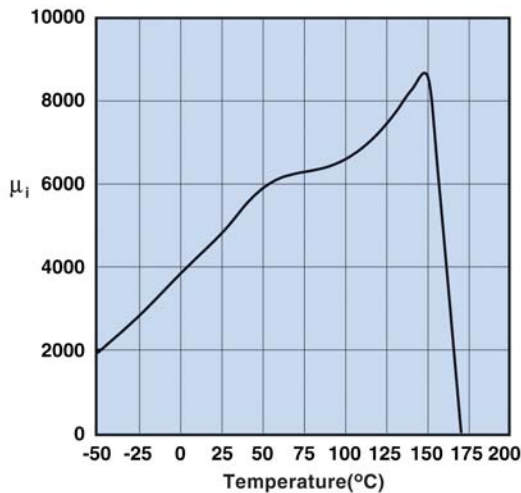

Measured on a 17/10/6mm toroid at 10 kHz.

Hysteresis Loop

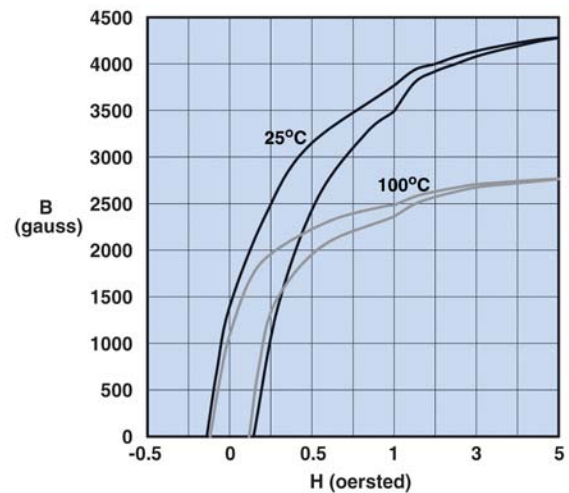

Measured on a 17/10/6mm toroid at 10 kHz.

A MnZn ferrite with a 10K permeability and an acceptable Curie temperature for broadband and pulse transformer designs and common-mode choke applications.

Toroids are available in 76 material.

76 Material Characteristics:

| Property | Unit | Symbol | Value |
|--|------------------|-----------------------|-------------|
| Initial Permeability @ B < 10 gauss | | μ_i | 10000 |
| Flux Density @ Field Strength | gauss oersted | B H | 4000 5 |
| Residual Flux Density | gauss | B_r | 1800 |
| Coercive Force | oersted | H_c | 0.12 |
| Loss Factor @ Frequency | 10^{-6} MHz | $\tan \delta / \mu_i$ | 15 0.025 |
| Temperature Coefficient of Initial Permeability (20 -70°C) | %/°C | | 0.5 |
| Curie Temperature | °C | T_c | >120 |
| Resistivity | Ω cm | ρ | 50 |

Complex Permeability vs. Frequency

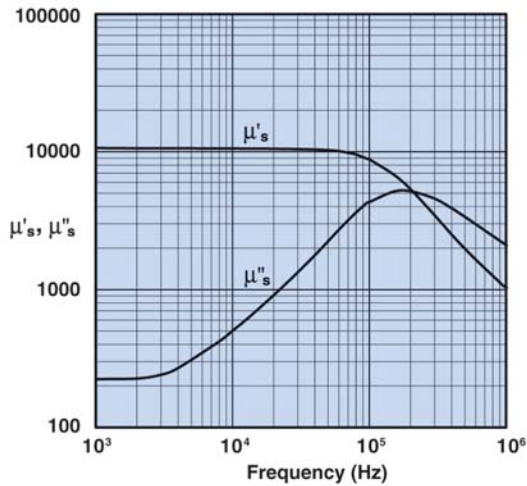

Measured on a 17/10/6mm toroid using the HP 4284A and, the HP 4291A.

Amplitude Permeability vs. Flux Density

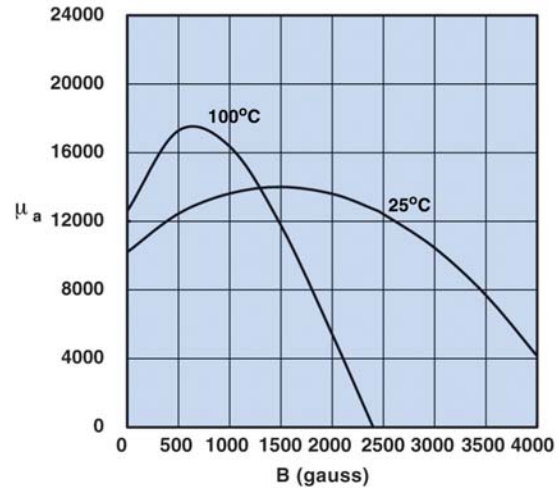

Measured on a 17/10/6mm toroid using the HP 54510A.

Initial Permeability vs. Temperature

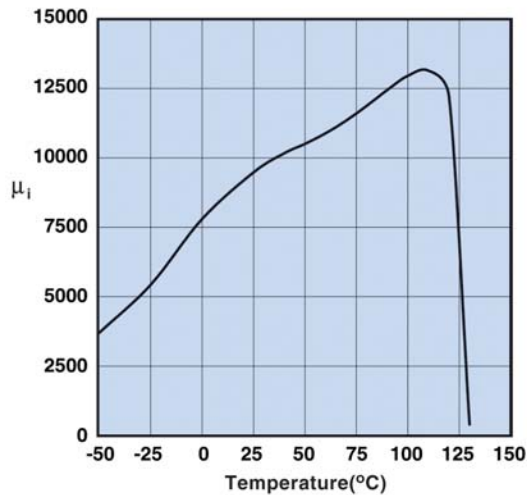

Measured on a 17/10/6mm toroid at 10 kHz.

Hysteresis Loop

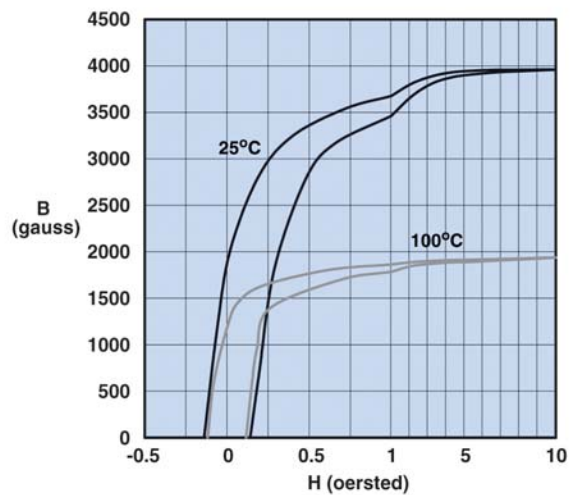

Measured on a 17/10/6mm toroid at 10 kHz.

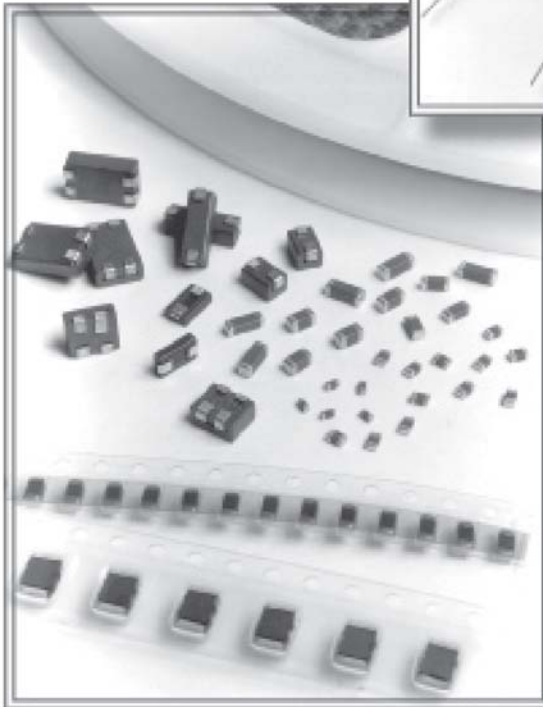
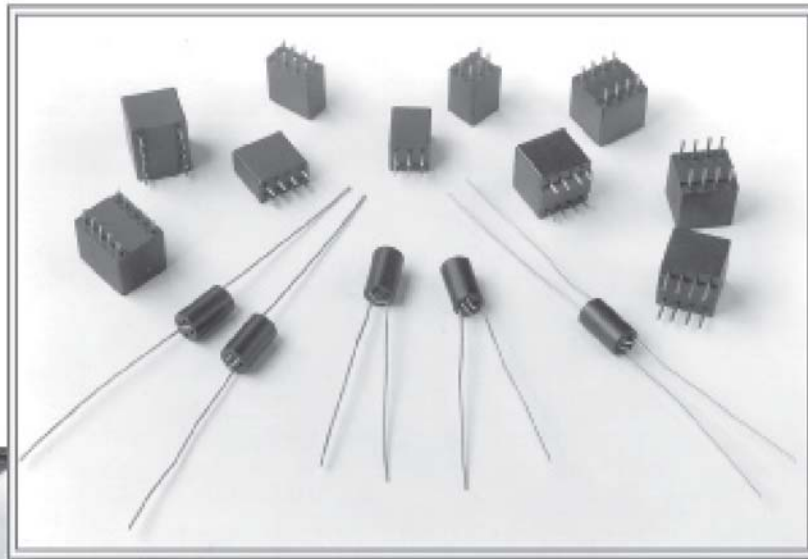

Fair-Rite Products Corp. PO Box 288, One Commercial Row, Wallkill, NY 12589-0288

Phone: (888) FAIR RITE / (845) 895-2055 • Fax: (888) FERRITE / (845) 895-2629 • Web: www.fair-rite.com
(888) 324-7748 (888) 337-7483 E -mail: ferrites@fair-rite.com

SUGGESTED REFLOW SOLDER PROFILE FOR LEAD-FREE COMPONENTS

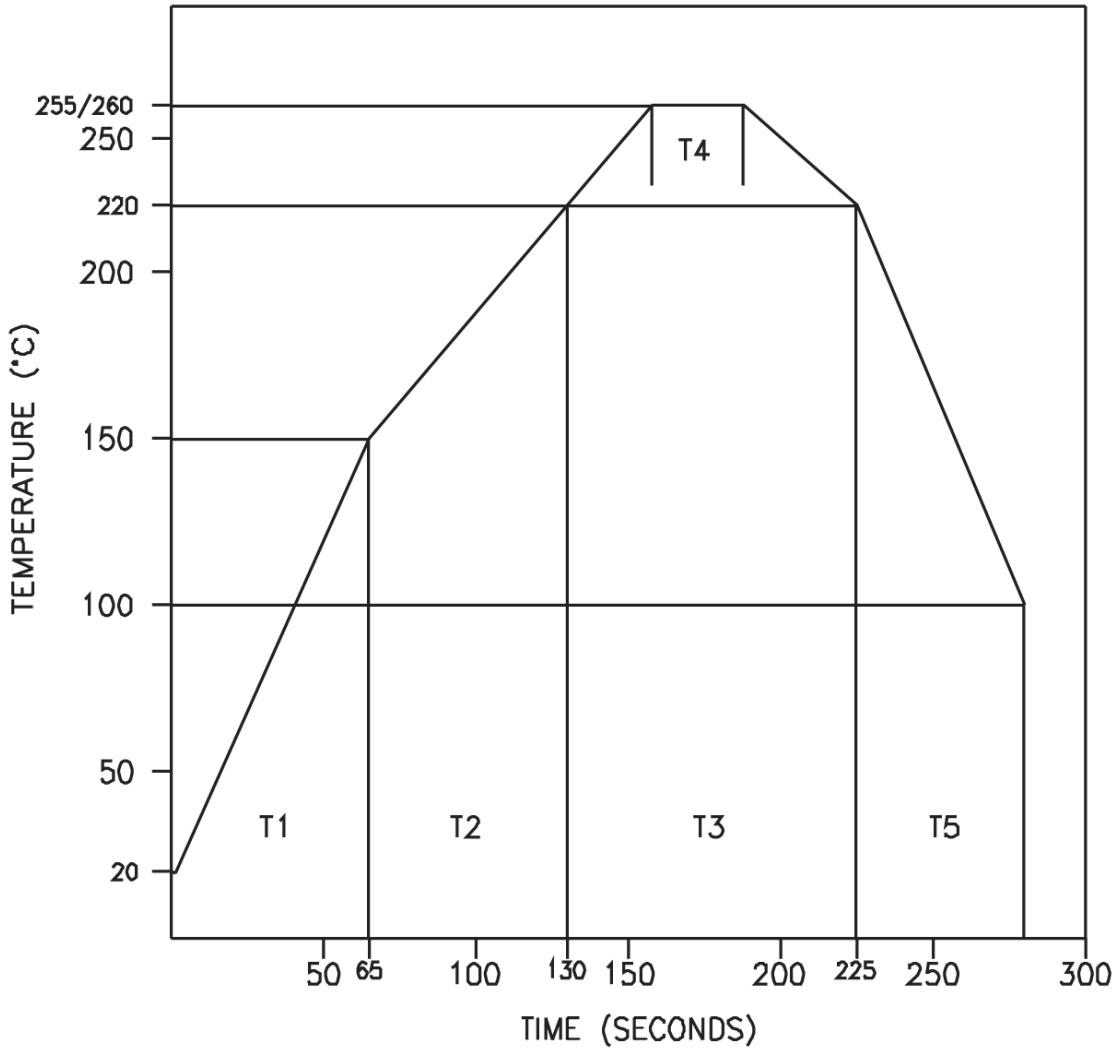

- | | |
|-------------------------|--------------------|
| T1 - Pre Heat | 50 - 80 Seconds |
| T2 - Soak Time | 60 - 90 Seconds |
| T3 - Time Above 220°C | 60 - 150 Seconds |
| T4 - Reflow Solder Time | 20 - 40 Seconds |
| T5 - Cool Down | 40 Seconds Minimum |

Times might be adjusted to accommodate component size

Fair-Rite offers a broad selection of ferrite EMI suppression beads with guaranteed minimum impedance specifications.

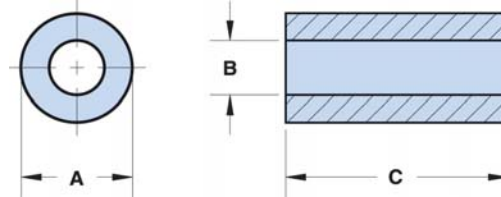

- Beads with a "1" as the last digit of the part number are not burnished. Parts that are burnished to break the sharp edges have a "2" as the last digit.
- Upon request beads can be supplied with a Parylene coating. The last digit of the Parylene coated part is a "4". The minimum coating thickness beads is 0.005 mm (0.0002").
- The column "H (Oe)" gives for each bead the calculated dc bias field in oersted for 1 turn and 1 ampere direct current. The actual dc H field in the application is this value of "H" times the actual NI (ampere-turn) product. For the effect of the dc bias on the impedance of the bead material, see figures 18-23 in the application note "How to choose Ferrite Components for EMI Suppression".
- Suppression beads are controlled for impedances only. Minimum impedance values are specified for the + marked frequencies. The minimum impedance is typically the listed impedance less 20%.
- Single turn impedance tests for 73 and 43 material beads are performed on the 4193A Vector Impedance Analyzer. The 61 material beads are tested on the 4291A RF Impedance Analyzer. **Beads are tested with the shortest practical wire length.**
- Performance curves for these suppression components are on our web site.
- For any EMI suppression bead requirement not listed here, feel free to contact our customer service for availability and pricing.
- The "C" dimension, the bead length, can be modified to suit specific applications.
- Our "Shield Bead Kit" (part number 0199000019) contains a selection of these beads.
- Explanation of Part Numbers: Digits 1&2 = product class, 3&4 = material grade and last digit 1= not burnished, 2 = burnished and 4 = Parylene coated.

EMI Suppression Beads



Quick Link: www.fair-rite.com/esb

Listed by frequency range and in ascending order of "B" dimension.

Legend

Dimensions (Top numbers are in millimeters, bottom numbers are in nominal inches.)

+ Test frequency

Lower Frequencies < 50 MHz (73 material)

| Part Number | A | B | C | Wt. (g) | H (Oe) | Impedance (Ω) | | | |
|-------------|--------------------------|--------------------------|---------------------------|---------|--------|------------------------|-------|---------------------|---------------------|
| | | | | | | 1 MHz | 5 MHz | 10 MHz ⁺ | 25 MHz ⁺ |
| 2673901301 | 0.95 -0.05 0.036 | 0.45 +0.10 0.020 | 3.80 \pm 0.20 0.150 | 0.01 | 6.00 | 5.3 | 13 | 16 | 24 |
| 2673004601 | 1.10 -0.10 0.041 | 0.65 +0.10 0.028 | 4.10 -0.30 0.156 | 0.01 | 4.70 | 3.3 | 8.2 | 12.5 | 19 |
| 2673004701 | 1.45 -0.15 0.054 | 0.70 +0.10 0.029 | 2.30 \pm 0.15 0.090 | 0.01 | 4.00 | 3.1 | 7.6 | 12.5 | 17 |
| 2673030101 | 1.22 -0.13 0.045 | 0.80 +0.10 0.033 | 5.30 -0.45 0.200 | 0.01 | 4.10 | 3.5 | 8.6 | 11 | 17 |
| 2673025301 | 1.25 -0.10 0.047 | 0.80 +0.10 0.033 | 3.80 \pm 0.20 0.150 | 0.01 | 4.00 | 2.9 | 7.1 | 10 | 15 |
| 2673004801 | 2.10 -0.15 0.080 | 0.85 +0.10 0.034 | 2.90 -0.45 0.105 | 0.03 | 3.10 | 5.5 | 13.5 | 18 | 28 |
| 2673028602 | 2.13 -0.10 0.082 | 0.85 +0.10 0.034 | 5.60 \pm 0.15 0.220 | 0.07 | 2.70 | 13 | 30.5 | 38 | 50 |
| 2673012401 | 1.55 -0.10 0.059 | 0.95 +0.15 0.040 | 4.20 -0.25 0.160 | 0.02 | 3.30 | 3.5 | 8.6 | 11 | 19 |
| 2673002201 | 1.95 -0.02 0.072 | 1.05 +0.10 0.043 | 10.40 \pm 0.25 0.410 | 0.09 | 2.90 | 14 | 33.5 | 38 | 55 |
| 2673000501 | 2.00 -0.15 0.076 | 1.05 +0.10 0.043 | 1.65 -0.25 0.060 | 0.01 | 2.80 | 2.1 | 6.3 | 7.5 | 12 |
| 2673000201 | 2.00 -0.15 0.076 | 1.05 +0.10 0.043 | 3.80 \pm 0.25 0.150 | 0.04 | 2.80 | 5.2 | 12.5 | 18 | 27 |
| 2673000101 | 3.50 \pm 0.20 0.138 | 1.30 \pm 0.10 0.051 | 3.25 \pm 0.25 0.128 | 0.13 | 2.00 | 8.1 | 19.5 | 25 | 35 |
| 2673000301 | 3.50 \pm 0.20 0.138 | 1.30 \pm 0.10 0.051 | 6.00 \pm 0.25 0.236 | 0.24 | 2.00 | 15.5 | 37.5 | 57 | 63 |
| 2673000701 | 3.50 \pm 0.20 0.138 | 1.30 \pm 0.10 0.051 | 12.70 \pm 0.35 0.500 | 0.51 | 2.00 | 34.5 | 81.5 | 120 | 125 |
| 2673022401 | 5.10 \pm 0.25 0.200 | 1.45 +0.25 0.062 | 6.35 \pm 0.25 0.250 | 0.56 | 1.50 | 20 | 47.5 | 54 | 58 |
| 2673021801 | 5.10 \pm 0.25 0.200 | 1.45 +0.25 0.062 | 11.10 \pm 0.35 0.437 | 1.00 | 1.50 | 35.5 | 84 | 94 | 95 |
| 2673018001 | 2.85 \pm 0.10 0.112 | 1.65 +0.15 0.068 | 6.65 \pm 0.25 0.262 | 0.13 | 1.80 | 8.3 | 20 | 29 | 41 |
| 2673004901 | 2.85 \pm 0.10 0.112 | 1.65 +0.15 0.068 | 10.45 \pm 0.25 0.410 | 0.20 | 1.80 | 13.5 | 32.5 | 40 | 58 |
| 2673001601 | 3.55 \pm 0.15 0.140 | 1.65 +0.25 0.070 | 3.30 -0.40 0.122 | 0.11 | 1.60 | 5.1 | 12.5 | 16 | 24 |
| 2673015301 | 4.10 -0.25 0.156 | 1.80 \pm 0.15 0.071 | 6.85 \pm 0.25 0.270 | 0.32 | 1.50 | 14 | 34 | 41 | 54 |
| 2673000801 | 7.50 \pm 0.25 0.296 | 2.25 +0.25 0.094 | 7.55 \pm 0.25 0.297 | 1.40 | 1.00 | 23 | 55.5 | 48 | 45 |
| 2673200201 | 5.20 \pm 0.15 0.205 | 2.65 \pm 0.25 0.105 | 20.60 \pm 0.75 0.812 | 1.60 | 1.10 | 37 | 89 | 110 | 113 |
| 2673003201 | 5.60 -0.50 0.210 | 2.65 \pm 0.25 0.105 | 12.70 \pm 0.50 0.500 | 1.00 | 1.10 | 23.5 | 56.5 | 60 | 60 |
| 2673002402 | 9.65 \pm 0.25 0.380 | 5.00 \pm 0.20 0.197 | 5.05 -0.45 0.190 | 1.20 | 0.59 | 7.9 | 19 | 19 | 15 |

Fair-Rite Products Corp. PO Box 288, One Commercial Row, Wallkill, NY 12589-0288

EMI Suppression Beads



Quick Link: www.fair-rite.com/esb

Listed by frequency range and in ascending order of "B" dimension.

Broadband Frequencies 25-300 MHz (43 material)

| Part Number | A | B | C | Wt. (g) | H (Oe) | Impedance (Ω) | | | |
|-------------|----------------------|---------------------|----------------------|---------|--------|---------------|---------------------|----------------------|---------|
| | | | | | | 10 MHz | 25 MHz ⁺ | 100 MHz ⁺ | 250 MHz |
| 2643004601 | 1.10 -0.10 0.041 | 0.65 +0.10 0.028 | 4.10 -0.30 0.156 | 0.10 | 4.70 | 9 | 12.5 | 31 | 39 |
| 2643004701 | 1.45 -0.15 0.054 | 0.70 +0.10 0.029 | 2.30 ±0.15 0.090 | 0.01 | 4.00 | 8 | 12.5 | 26 | 39 |
| 2643020501 | 1.65 ±0.025 0.065 | 0.85 +0.10 0.034 | 3.68 -0.25 0.140 | 0.02 | 3.40 | 12 | 17 | 31 | 47 |
| 2643004801 | 2.10 -0.15 0.080 | 0.85 +0.10 0.034 | 2.90 -0.45 0.105 | 0.03 | 3.10 | 12 | 18 | 31 | 47 |
| 2643002201 | 1.95 -0.20 0.072 | 1.05 +0.10 0.043 | 10.40 ±0.25 0.410 | 0.08 | 2.90 | 26 | 34 | 58 | 77 |
| 2643000501 | 2.00 -0.15 0.076 | 1.05 +0.10 0.043 | 1.65 -0.25 0.060 | 0.01 | 2.80 | 6 | 9 | 22 | 33 |
| 2643000201 | 2.00 -0.15 0.076 | 1.05 +0.10 0.043 | 3.80 ±0.25 0.150 | 0.03 | 2.80 | 12 | 16 | 31 | 46 |
| 2643000101 | 3.50 ±0.20 0.138 | 1.30 ±0.10 0.051 | 3.25 ±0.25 0.128 | 0.10 | 2.00 | 17 | 26 | 40 | 56 |
| 2643000301 | 3.50 ±0.20 0.138 | 1.30 ±0.10 0.051 | 6.00 ±0.25 0.236 | 0.18 | 2.00 | 29 | 46 | 60 | 83 |
| 2643000701 | 3.50 ±0.20 0.138 | 1.30 ±0.10 0.051 | 12.70 ±0.35 0.500 | 0.38 | 2.00 | 60 | 89 | 125 | 148 |
| 2643200101 | 5.10 ±0.25 0.200 | 1.45 +0.25 0.062 | 3.40 -0.45 0.125 | 0.19 | 1.50 | 19 | 30 | 41 | 61 |
| 2643022401 | 5.10 ±0.25 0.200 | 1.45 +0.25 0.062 | 6.35 ±0.25 0.250 | 0.38 | 1.50 | 36 | 55 | 82 | 97 |
| 2643021801 | 5.10 ±0.25 0.200 | 1.45 +0.25 0.062 | 11.10 ±0.35 0.437 | 0.67 | 1.50 | 62 | 96 | 131 | 151 |
| 2643001501 | 3.50 ±0.20 0.138 | 1.60 ±0.10 0.063 | 3.25 ±0.25 0.128 | 0.10 | 1.70 | 13 | 21 | 35 | 50 |
| 2643025601 | 3.50 ±0.20 0.138 | 1.60 ±0.10 0.063 | 6.00 ±0.25 0.236 | 0.18 | 1.70 | 23 | 38 | 55 | 70 |
| 2643023201 | 2.85 ±0.10 0.112 | 1.65 ±0.15 0.068 | 3.75 ±0.25 0.147 | 0.06 | 1.80 | 10 | 15 | 30 | 43 |
| 2643013801 | 3.50 ±0.20 0.138 | 1.65 +0.25 0.070 | 4.05 ±0.25 0.160 | 0.12 | 1.60 | 14 | 24 | 38 | 52 |
| 2643001601 | 3.55 ±0.15 0.140 | 1.65 +0.25 0.070 | 3.30 -0.40 0.122 | 0.09 | 1.60 | 11 | 19 | 30 | 46 |
| 2643001301 | 3.55 ±0.15 0.140 | 1.65 +0.25 0.070 | 5.95 ±0.25 0.234 | 0.18 | 1.60 | 21 | 31 | 48 | 65 |
| 2643005701 | 5.10 ±0.25 0.200 | 2.30 ±0.20 0.090 | 12.70 ±0.35 0.500 | 0.81 | 1.20 | 49 | 78 | 120 | 123 |
| 2643000801 | 7.50 ±0.20 0.296 | 2.25 +0.25 0.094 | 7.55 ±0.25 0.297 | 1.00 | 1.00 | 42 | 63 | 92 | 109 |
| 2643300101 | 7.60 ±0.25 0.300 | 2.25 +0.25 0.094 | 15.10 ±0.75 0.595 | 2.10 | 1.00 | 83 | 115 | 200 | 195 |
| 2643003201 | 5.60 -0.50 0.210 | 2.65 ±0.25 0.105 | 12.70 ±0.50 0.500 | 0.87 | 1.10 | 42 | 63 | 88 | 110 |
| 2643250402 | 6.35 ±0.15 0.250 | 2.95 +0.45 0.125 | 12.70 ±0.50 0.500 | 1.20 | 0.91 | 43 | 69 | 102 | 111 |
| 2643250302 | 6.35 ±0.15 0.250 | 2.95 +0.45 0.125 | 15.90 ±0.50 0.625 | 1.50 | 0.91 | 53 | 85 | 122 | 132 |
| 2643250202 | 6.35 ±0.15 0.250 | 2.95 +0.45 0.125 | 25.40 ±0.75 1.000 | 2.50 | 0.91 | 83 | 135 | 200 | 196 |
| 2643375102 | 9.50 ±0.25 0.375 | 4.50 +0.75 0.192 | 6.35 ±0.35 0.250 | 1.40 | 0.60 | 21 | 35 | 50 | 66 |
| 2643375002 | 9.50 ±0.25 0.375 | 4.50 +0.75 0.192 | 14.50 ±0.60 0.570 | 3.10 | 0.60 | 47 | 78 | 115 | 119 |
| 2643006302 | 9.50 ±0.25 0.375 | 4.75 +0.30 0.193 | 10.40 ±0.25 0.410 | 2.20 | 0.60 | 34 | 53 | 80 | 92 |
| 2643023402 | 9.50 ±0.25 0.375 | 4.75 +0.30 0.193 | 15.90 ±0.45 0.625 | 3.40 | 0.60 | 51 | 83 | 120 | 127 |

Fair-Rite Products Corp. PO Box 288, One Commercial Row, Wallkill, NY 12589-0288

Phone: (888) FAIR RITE / (845) 895-2055 • Fax: (888) FERRITE / (845) 895-2629 • Web: www.fair-rite.com
 (888) 324-7748 (888) 337-7483 E -mail: ferrites@fair-rite.com

EMI Suppression Beads



Quick Link: www.fair-rite.com/esb

Listed by frequency range and in ascending order of "B" dimension.

Broadband Frequencies 25-300 MHz (43 material)

| Part Number | A | B | C | Wt. (g) | H (Oe) | Impedance (Ω) | | | |
|-------------|--------------------------|--------------------------|---------------------------|---------|--------|------------------------|---------------------|----------------------|---------|
| | | | | | | 10 MHz | 25 MHz ⁺ | 100 MHz ⁺ | 250 MHz |
| 2643023002 | 9.50 \pm 0.25 0.375 | 4.75 +0.30 0.193 | 19.05 \pm 0.70 0.750 | 4.10 | 0.60 | 60 | 100 | 145 | 148 |
| 2643002402 | 9.65 \pm 0.25 0.380 | 5.00 \pm 0.20 0.197 | 5.05 -0.45 0.190 | 1.10 | 0.59 | 16 | 26 | 43 | 56 |
| 2643012702 | 9.65 \pm 0.25 0.380 | 6.35 \pm 0.15 0.250 | 7.35 \pm 0.25 0.290 | 1.30 | 0.51 | 15 | 24 | 38 | 55 |

Higher Frequencies 250-1000 MHz (61 material)

| Part Number | A | B | C | Wt. (g) | H (Oe) | Impedance (Ω) | | | |
|-------------|--------------------------|--------------------------|---------------------------|---------|--------|------------------------|----------------------|----------------------|----------|
| | | | | | | 100 MHz | 250 MHz ⁺ | 500 MHz ⁺ | 1000 MHz |
| 2661000101 | 3.50 \pm 0.20 0.138 | 1.30 \pm 0.10 0.051 | 3.25 \pm 0.25 0.128 | 0.10 | 2.00 | 30 | 45 | 62 | 95 |
| 2661000301 | 3.50 \pm 0.20 0.138 | 1.30 \pm 0.10 0.051 | 6.00 \pm 0.25 0.236 | 0.18 | 2.00 | 54 | 82 | 103 | 120 |
| 2661000701 | 3.50 \pm 0.20 0.138 | 1.30 \pm 0.10 0.051 | 12.70 \pm 0.35 0.500 | 0.38 | 2.00 | 120 | 158 | 178 | 185 |
| 2661022401 | 5.10 \pm 0.25 0.200 | 1.45 +0.25 0.062 | 6.35 \pm 0.25 0.250 | 0.38 | 1.50 | 58 | 82 | 103 | 138 |
| 2661021801 | 5.10 \pm 0.25 0.200 | 1.45 +0.25 0.062 | 11.10 \pm 0.35 0.437 | 0.67 | 1.50 | 102 | 141 | 167 | 185 |
| 2661023801 | 5.10 \pm 0.25 0.200 | 1.45 +0.25 0.062 | 22.85 \pm 0.75 0.900 | 1.40 | 1.50 | 210 | 286 | 325 | 350 |
| 2661000801 | 7.50 \pm 0.25 0.296 | 2.25 +0.25 0.094 | 7.55 \pm 0.25 0.297 | 1.00 | 1.00 | 75 | 103 | 120 | 143 |
| 2661250402 | 6.35 \pm 0.15 0.250 | 2.95 +0.45 0.125 | 12.70 \pm 0.50 0.500 | 1.20 | 0.91 | 85 | 115 | 135 | 155 |
| 2661375102 | 9.50 \pm 0.25 0.375 | 4.50 +0.75 0.192 | 6.35 \pm 0.35 0.250 | 2.50 | 0.60 | 42 | 63 | 83 | 117 |

Fair-Rite Products Corp. PO Box 288, One Commercial Row, Walkill, NY 12589-0288

Ferrite suppression beads are supplied assembled on tinned copper wire for automated circuit board assembly.

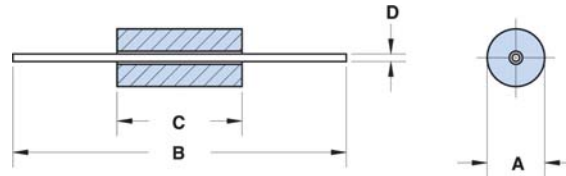

- Parts with a "2" as the last digit of the part number are supplied taped and reeled per IEC 60286-1 and EIA RS-296-F standards. Taped and reeled parts are supplied 4500 pieces on a 14" reel. Taping details: Component pitch 5 mm. Inside tape spacing 52.5 mm. Tape width 6 mm.
- Beads-on-leads can be supplied bulk packed. The last digit of bulk packed parts is a "1".
- Wires are oxygen free high conductivity copper with 100% matte tin plating over a nickel undercoating. The resistance of the wire is 3.5 mOhm for the 22 AWG and 2.2 mOhm for the 20 AWG wire.
- Beads-on-leads are controlled for impedances only. Minimum impedance values are specified for the + marked frequencies. The minimum impedance is typically the listed impedance less 20%. The impedances of the 73 & 43 beads-on-leads are measured on the 4193A Vector Impedance Analyzer. The 61 beads-on-leads are tested for impedance on the 4291A RF Impedance Analyzer.
- Performance curves for these suppression components are on our web site.
- For any bead-on lead requirement not listed here, feel free to contact our customer service group for availability and pricing.
- Our "Bead-on-Lead Suppression Kit" (part number 0199000028) is available for prototype evaluation.
- Explanation of Part Numbers: Digits 1&2 = product class, 3&4 = material grade and last digit 1 = bulk packed, 2 = taped and reeled.

Legend

Dimensions (Top numbers are in millimeters, bottom numbers are in nominal inches.)

⁺ Test frequency

Lower Frequencies < 50 MHz (73 material)

| Part Number | A | B | C | D | Wt. (g) | Impedance (Ω) | | | | Reel Information | | |
|-------------|---------------------|----------------------|---------------------|----------------|---------|---------------|-------|---------------------|---------------------|------------------|----------|----------------|
| | | | | | | 1 MHz | 5 MHz | 10 MHz ⁺ | 25 MHz ⁺ | Tape Width mm | Pitch mm | Parts 14" Reel |
| 2773001112 | 3.50 ±0.25 0.138 | 62.00 ±1.50 2.440 | 4.45 ±0.25 0.175 | 0.65 22 AWG | 0.40 | 12 | 34 | 48 | 61 | 6 | 5 | 4500 |
| 2773001111 | 3.50 ±0.25 0.138 | 62.00 ±1.50 2.440 | 4.45 ±0.25 0.175 | 0.65 22 AWG | 0.40 | 12 | 34 | 48 | 61 | - | - | - |
| 2773015112 | 3.50 ±0.25 0.138 | 62.00 ±1.50 2.440 | 5.25 ±0.25 0.206 | 0.65 22 AWG | 0.40 | 17 | 43 | 55 | 68 | 6 | 5 | 4500 |
| 2773015111 | 3.50 ±0.25 0.138 | 62.00 ±1.50 2.440 | 5.25 ±0.25 0.206 | 0.65 22 AWG | 0.40 | 17 | 43 | 55 | 68 | - | - | - |
| 2773005112 | 3.50 ±0.25 0.138 | 62.00 ±1.50 2.440 | 6.00 ±0.25 0.236 | 0.65 22 AWG | 0.40 | 22 | 51 | 63 | 78 | 6 | 5 | 4500 |
| 2773005111 | 3.50 ±0.25 0.138 | 62.00 ±1.50 2.440 | 6.00 ±0.25 0.236 | 0.65 22 AWG | 0.40 | 22 | 51 | 63 | 78 | - | - | - |
| 2773003112 | 3.50 ±0.25 0.138 | 62.00 ±1.50 2.440 | 6.70 ±0.25 0.263 | 0.65 22 AWG | 0.50 | 26 | 59 | 70 | 86 | 6 | 5 | 4500 |
| 2773003111 | 3.50 ±0.25 0.138 | 62.00 ±1.50 2.440 | 6.70 ±0.25 0.263 | 0.65 22 AWG | 0.50 | 26 | 59 | 70 | 86 | - | - | - |
| 2773004112 | 3.50 ±0.25 0.138 | 62.00 ±1.50 2.440 | 7.60 ±0.30 0.300 | 0.65 22 AWG | 0.50 | 30 | 69 | 80 | 100 | 6 | 5 | 4500 |

Lower Frequencies < 50 MHz (73 material)

| Part Number | A | B | C | D | Wt. (g) | Impedance (Ω) | | | | Reel Information | | |
|-------------|--------------------------|---------------------------|---------------------------|----------------|---------|------------------------|-------|---------------------|---------------------|------------------|----------|----------------|
| | | | | | | 1 MHz | 5 MHz | 10 MHz ⁺ | 25 MHz ⁺ | Tape Width mm | Pitch mm | Parts 14" Reel |
| 2773004111 | 3.50 \pm 0.25 0.138 | 62.00 \pm 1.50 2.440 | 7.60 \pm 0.30 0.300 | 0.65 22 AWG | 0.50 | 30 | 69 | 80 | 100 | - | - | - |
| 2773002112 | 3.50 \pm 0.25 0.138 | 62.00 \pm 1.50 2.440 | 8.90 \pm 0.30 0.350 | 0.65 22 AWG | 0.60 | 36 | 84 | 94 | 115 | 6 | 5 | 4500 |
| 2773002111 | 3.50 \pm 0.25 0.138 | 62.00 \pm 1.50 2.440 | 8.90 \pm 0.30 0.350 | 0.65 22 AWG | 0.60 | 36 | 84 | 94 | 115 | - | - | - |
| 2773007112 | 3.50 \pm 0.25 0.138 | 62.00 \pm 1.50 2.440 | 9.50 \pm 0.30 0.374 | 0.65 22 AWG | 0.60 | 38 | 90 | 110 | 115 | 6 | 5 | 4500 |
| 2773007111 | 3.50 \pm 0.25 0.138 | 62.00 \pm 1.50 2.440 | 9.50 \pm 0.30 0.374 | 0.65 22 AWG | 0.60 | 38 | 90 | 110 | 115 | - | - | - |
| 2773008112 | 3.50 \pm 0.25 0.138 | 62.00 \pm 1.50 2.440 | 11.40 \pm 0.40 0.450 | 0.65 22 AWG | 0.70 | 43 | 112 | 125 | 145 | 6 | 5 | 4500 |
| 2773008111 | 3.50 \pm 0.25 0.138 | 62.00 \pm 1.50 2.440 | 11.40 \pm 0.40 0.450 | 0.65 22 AWG | 0.70 | 43 | 112 | 125 | 145 | - | - | - |
| 2773009112 | 3.50 \pm 0.25 0.138 | 62.00 \pm 1.50 2.440 | 13.80 \pm 0.50 0.545 | 0.65 22 AWG | 0.70 | 46 | 138 | 151 | 170 | 6 | 5 | 4500 |
| 2773009111 | 3.50 \pm 0.25 0.138 | 62.00 \pm 1.50 2.440 | 13.80 \pm 0.50 0.545 | 0.65 22 AWG | 0.70 | 46 | 138 | 151 | 170 | - | - | - |

Broadband Frequencies 25-300 MHz (43 material)

| Part Number | A | B | C | D | Wt. (g) | Impedance (Ω) | | | | Reel Information | | |
|-------------|--------------------------|---------------------------|---------------------------|----------------|---------|------------------------|---------------------|----------------------|---------|------------------|----------|----------------|
| | | | | | | 10 MHz | 25 MHz ⁺ | 100 MHz ⁺ | 250 MHz | Tape Width mm | Pitch mm | Parts 14" Reel |
| 2743001112 | 3.50 \pm 0.25 0.138 | 62.00 \pm 1.50 2.440 | 4.45 \pm 0.25 0.175 | 0.65 22 AWG | 0.40 | 31 | 49 | 68 | 65 | 6 | 5 | 4500 |
| 2743001111 | 3.50 \pm 0.25 0.138 | 62.00 \pm 1.50 2.440 | 4.45 \pm 0.25 0.175 | 0.65 22 AWG | 0.40 | 31 | 49 | 68 | 65 | - | - | - |
| 2743015112 | 3.50 \pm 0.25 0.138 | 62.00 \pm 1.50 2.440 | 5.25 \pm 0.25 0.206 | 0.65 22 AWG | 0.40 | 36 | 54 | 82 | 78 | 6 | 5 | 4500 |
| 2743015111 | 3.50 \pm 0.25 0.138 | 62.00 \pm 1.50 2.440 | 5.25 \pm 0.25 0.206 | 0.65 22 AWG | 0.40 | 36 | 54 | 82 | 78 | - | - | - |
| 2743005112 | 3.50 \pm 0.25 0.138 | 62.00 \pm 1.50 0.244 | 6.00 \pm 0.25 0.236 | 0.65 22 AWG | 0.40 | 40 | 60 | 91 | 90 | 6 | 5 | 4500 |
| 2743005111 | 3.50 \pm 0.25 0.138 | 62.00 \pm 1.50 0.244 | 6.00 \pm 0.25 0.236 | 0.65 22 AWG | 0.40 | 40 | 60 | 91 | 90 | - | - | - |
| 2743003112 | 3.50 \pm 0.25 0.138 | 62.00 \pm 1.50 0.244 | 6.70 \pm 0.25 0.263 | 0.65 22 AWG | 0.50 | 44 | 65 | 100 | 101 | 6 | 5 | 4500 |
| 2743003111 | 3.50 \pm 0.25 0.138 | 62.00 \pm 1.50 0.244 | 6.70 \pm 0.25 0.263 | 0.65 22 AWG | 0.50 | 44 | 65 | 100 | 101 | - | - | - |
| 2743004112 | 3.50 \pm 0.25 0.138 | 62.00 \pm 1.50 2.440 | 7.60 \pm 0.30 0.300 | 0.65 22 AWG | 0.50 | 50 | 75 | 110 | 115 | 6 | 5 | 4500 |
| 2743004111 | 3.50 \pm 0.25 0.138 | 62.00 \pm 1.50 2.440 | 7.60 \pm 0.30 0.300 | 0.65 22 AWG | 0.50 | 50 | 75 | 110 | 115 | - | - | - |
| 2743002112 | 3.50 \pm 0.25 0.138 | 62.00 \pm 1.50 2.440 | 8.90 \pm 0.30 0.350 | 0.65 22 AWG | 0.60 | 57 | 88 | 133 | 134 | 6 | 5 | 4500 |
| 2743002111 | 3.50 \pm 0.25 0.138 | 62.00 \pm 1.50 2.440 | 8.90 \pm 0.30 0.350 | 0.65 22 AWG | 0.60 | 57 | 88 | 133 | 134 | - | - | - |
| 2743007112 | 3.50 \pm 0.25 0.138 | 62.00 \pm 1.50 2.440 | 9.50 \pm 0.30 0.374 | 0.65 22 AWG | 0.60 | 61 | 96 | 150 | 143 | 6 | 5 | 4500 |
| 2743007111 | 3.50 \pm 0.25 0.138 | 62.00 \pm 1.50 2.440 | 9.50 \pm 0.30 0.374 | 0.65 22 AWG | 0.60 | 61 | 96 | 150 | 143 | - | - | - |
| 2743008112 | 3.50 \pm 0.25 0.138 | 62.00 \pm 1.50 2.440 | 11.40 \pm 0.40 0.450 | 0.65 22 AWG | 0.70 | 72 | 116 | 180 | 168 | 6 | 5 | 4500 |
| 2743008111 | 3.50 \pm 0.25 0.138 | 62.00 \pm 1.50 2.440 | 11.40 \pm 0.40 0.450 | 0.65 22 AWG | 0.70 | 72 | 116 | 180 | 168 | - | - | - |

Broadband Frequencies 25-300 MHz (43 material)

| Part Number | A | B | C | D | Wt. (g) | Impedance (Ω) | | | | Reel Information | | |
|-------------|--------------------------|---------------------------|---------------------------|----------------|---------|------------------------|---------------------|----------------------|---------|------------------|----------|----------------|
| | | | | | | 10 MHz | 25 MHz ⁺ | 100 MHz ⁺ | 250 MHz | Tape Width mm | Pitch mm | Parts 14" Reel |
| 2743009112 | 3.50 \pm 0.25 0.138 | 62.00 \pm 1.50 2.440 | 13.80 \pm 0.50 0.545 | 0.65 22 AWG | 0.70 | 86 | 143 | 220 | 196 | 6 | 5 | 4500 |
| 2743009111 | 3.50 \pm 0.25 0.138 | 62.00 \pm 1.50 2.440 | 13.80 \pm 0.50 0.545 | 0.65 22 AWG | 0.70 | 86 | 143 | 220 | 196 | - | - | - |
| 2743012201 | 9.80 \pm 0.30 0.385 | 62.00 \pm 1.50 2.440 | 11.40 \pm 0.40 0.449 | 0.80 20 AWG | 4.50 | 121 | 193 | 271 | 253 | - | - | - |
| 2743013211 | 9.80 \pm 0.30 0.385 | 62.00 \pm 1.50 2.440 | 14.00 \pm 0.50 0.550 | 0.80 20 AWG | 5.50 | 147 | 235 | 331 | 281 | - | - | - |
| 2743014221 | 9.80 \pm 0.30 0.385 | 62.00 \pm 1.50 2.440 | 16.50 \pm 0.50 0.650 | 0.80 20 AWG | 6.50 | 173 | 280 | 391 | 296 | - | - | - |

Higher Frequencies 250-1000 MHz (61 material)

| Part Number | A | B | C | D | Wt. (g) | Impedance (Ω) | | | | Reel Information | | |
|-------------|--------------------------|---------------------------|---------------------------|----------------|---------|------------------------|----------------------|----------------------|----------|------------------|----------|----------------|
| | | | | | | 100 MHz | 250 MHz ⁺ | 500 MHz ⁺ | 1000 MHz | Tape Width mm | Pitch mm | Parts 14" Reel |
| 2761001112 | 3.50 \pm 0.25 0.138 | 62.00 \pm 1.50 2.440 | 4.45 \pm 0.25 0.175 | 0.65 22 AWG | 0.40 | 52 | 72 | 83 | 90 | 6 | 5 | 4500 |
| 2761001111 | 3.50 \pm 0.25 0.138 | 62.00 \pm 1.50 2.440 | 4.45 \pm 0.25 0.175 | 0.65 22 AWG | 0.40 | 52 | 72 | 83 | 90 | - | - | - |
| 2761015112 | 3.50 \pm 0.25 0.138 | 62.00 \pm 1.50 2.440 | 5.25 \pm 0.25 0.206 | 0.65 22 AWG | 0.40 | 62 | 85 | 97 | 105 | 6 | 5 | 4500 |
| 2761015111 | 3.50 \pm 0.25 0.138 | 62.00 \pm 1.50 2.440 | 5.25 \pm 0.25 0.206 | 0.65 22 AWG | 0.40 | 62 | 85 | 97 | 105 | - | - | - |
| 2761004112 | 3.50 \pm 0.25 0.138 | 62.00 \pm 1.50 2.440 | 7.60 \pm 0.30 0.300 | 0.65 22 AWG | 0.50 | 89 | 121 | 138 | 148 | 6 | 5 | 4500 |
| 2761004111 | 3.50 \pm 0.25 0.138 | 62.00 \pm 1.50 2.440 | 7.60 \pm 0.30 0.300 | 0.65 22 AWG | 0.50 | 89 | 121 | 138 | 148 | - | - | - |
| 2761002112 | 3.50 \pm 0.25 0.138 | 62.00 \pm 1.50 2.440 | 8.90 \pm 0.30 0.350 | 0.65 22 AWG | 0.60 | 105 | 142 | 161 | 171 | 6 | 5 | 4500 |
| 2761002111 | 3.50 \pm 0.25 0.138 | 62.00 \pm 1.50 2.440 | 8.90 \pm 0.30 0.350 | 0.65 22 AWG | 0.60 | 105 | 142 | 161 | 171 | - | - | - |
| 2761007112 | 3.50 \pm 0.25 0.138 | 62.00 \pm 1.50 2.440 | 9.50 \pm 0.30 0.374 | 0.65 22 AWG | 0.60 | 112 | 151 | 171 | 182 | 6 | 5 | 4500 |
| 2761007111 | 3.50 \pm 0.25 0.138 | 62.00 \pm 1.50 2.440 | 9.50 \pm 0.30 0.374 | 0.65 22 AWG | 0.60 | 112 | 151 | 171 | 182 | - | - | - |
| 2761008112 | 3.50 \pm 0.25 0.138 | 62.00 \pm 1.50 2.440 | 11.40 \pm 0.40 0.450 | 0.65 22 AWG | 0.70 | 134 | 181 | 204 | 217 | 6 | 5 | 4500 |
| 2761008111 | 3.50 \pm 0.25 0.138 | 62.00 \pm 1.50 2.440 | 11.40 \pm 0.40 0.450 | 0.65 22 AWG | 0.70 | 134 | 181 | 204 | 217 | - | - | - |
| 2761009112 | 3.50 \pm 0.25 0.138 | 62.00 \pm 1.50 2.440 | 13.80 \pm 0.50 0.545 | 0.65 22 AWG | 0.70 | 162 | 218 | 246 | 261 | 6 | 5 | 4500 |
| 2761009111 | 3.50 \pm 0.25 0.138 | 62.00 \pm 1.50 2.440 | 13.80 \pm 0.50 0.545 | 0.65 22 AWG | 0.70 | 162 | 218 | 246 | 261 | - | - | - |

PC Beads (Through Hole)



Quick Link: www.fair-rite.com/pcb

Multiple single turn or multi-turn printed circuit EMI suppression beads are available in two Fair-Rite materials. The broadband 44 material and in the high frequency 52 material grade.

- PC Beads can be supplied with lower component heights "C". Also, the wire length "F" can be modified to specific requirements.
- Wires are oxygen free high conductivity copper with 100% matte tin plating over a nickel undercoating. Wires on top of the beads are covered with a layer of epoxy.
- PC Beads are controlled for impedance only. Minimum impedance values are specified for the + marked frequencies. The minimum impedance is typically the listed impedance less 20%.
- The PC Beads in 44 material are measured on the 4193A Vector Impedance Analyzer. The 52 PC Beads are tested for impedance on the 4291A RF Impedance Analyzer.
- Recommended operating and storage temperature for the PC Beads is -55 °C to +125 °C.
- Performance curves for these suppression components are on our web site.
- Explanation of Part Numbers: Digits 1&2 = product class, 3&4 = material grade and last digit 1 = standard wire length 2.4 mm (0.095") minimum, 2 = wire length 3.1 mm (0.122") minimum.

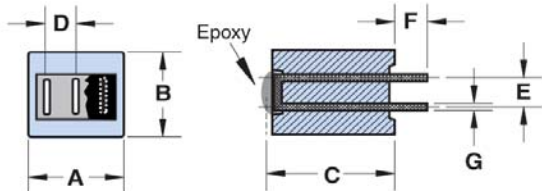

Figure 1

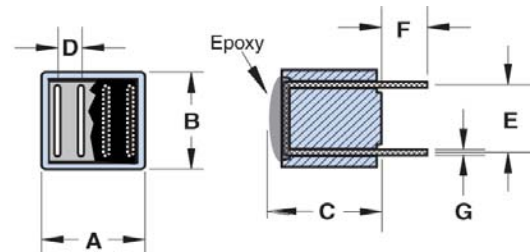

Figure 3

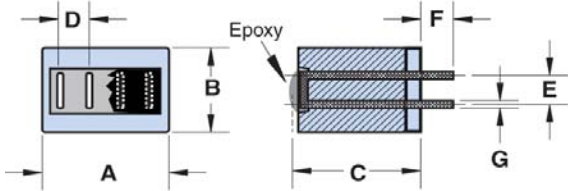

Figure 2

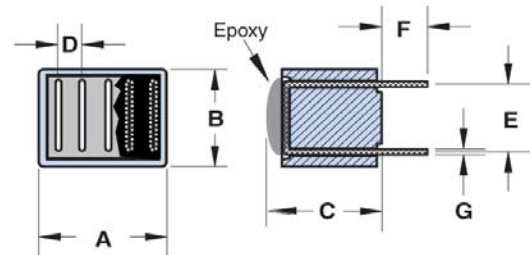

Figure 4

Typical Multi Turn Printed Circuit Board Layouts

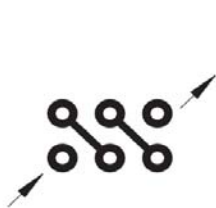

Figure 1A:
3 Turn winding
for parts in Fig.1

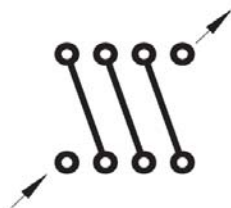

Figure 3A:
4 Turn turn winding
for parts in Fig.3.

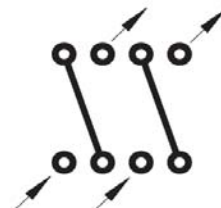

Figure 3B:
2 x 2 Turn winding
for parts in Fig.3.

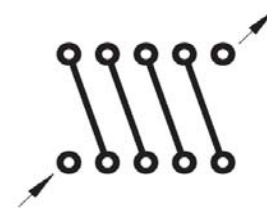

Figure 4A:
5 Turn winding
for parts in Fig.4.

Fair-Rite Products Corp. PO Box 288, One Commercial Row, Wallkill, NY 12589-0288

Phone: (888) FAIR RITE / (845) 895-2055 • Fax: (888) FERRITE / (845) 895-2629 • Web: www.fair-rite.com
(888) 324-7748 (888) 337-7483 E-mail: ferrites@fair-rite.com

PC Beads (Through Hole)



Quick Link: www.fair-rite.com/pcb

Legend

Dimensions (Top numbers are in millimeters, bottom numbers are in nominal inches.)

* Test frequency

Broadband Frequencies 10-300 MHz (44 material)

| Part Number | Fig. | A | B | C | D | E | F | G | Wt. (g) | Impedance (Ω) | | | |
|-------------|------|----------------------|----------------------|------------------------|---------------------|---------------------|-----------------------|----------------|---------|---------------|---------------------|----------------------|---------|
| | | | | | | | | | | 10 MHz | 25 MHz ⁺ | 100 MHz ⁺ | 250 MHz |
| 2944776101 | 1 | 8.00 -0.35 0.308 | 7.60 -0.50 0.290 | 11.80 Max 0.464 Max | 2.54 ±0.10 0.100 | 2.54 ±0.10 0.100 | 2.40 Min 0.095 Min | 0.65 22 AWG | 2.60 | 115 | 188 | 288 | 305 |
| 2944778101 | 2 | 11.20 -0.50 0.430 | 5.75 -0.50 0.216 | 11.80 Max 0.464 Max | 2.54 ±0.10 0.100 | 2.54 ±0.10 0.100 | 2.40 Min 0.095 Min | 0.65 22 AWG | 2.70 | 115 | 188 | 288 | 305 |
| 2944778301 | 3 | 11.20 -0.50 0.430 | 11.20 -0.50 0.430 | 11.80 Max 0.464 Max | 2.54 ±0.10 0.100 | 7.60 ±0.20 0.300 | 2.40 Min 0.095 Min | 0.65 22 AWG | 6.00 | 142 | 219 | 338 | 335 |
| 2944770301 | 4 | 13.45 ±0.25 0.530 | 11.20 -0.50 0.430 | 11.80 Max 0.464 Max | 2.54 ±0.10 0.100 | 7.60 ±0.20 0.300 | 2.40 Min 0.095 Min | 0.65 22 AWG | 7.40 | 142 | 219 | 338 | 335 |

Higher Frequencies 250-1000 MHz (52 material)

| Part Number | Fig. | A | B | C | D | E | F | G | Wt. (g) | Impedance (Ω) | | | |
|-------------|------|----------------------|----------------------|------------------------|---------------------|---------------------|-----------------------|----------------|---------|---------------|----------------------|----------------------|----------|
| | | | | | | | | | | 100 MHz | 250 MHz ⁺ | 500 MHz ⁺ | 1000 MHz |
| 2952776101 | 1 | 8.00 -0.35 0.308 | 7.60 -0.50 0.290 | 11.80 Max 0.464 Max | 2.54 ±0.10 0.100 | 2.54 ±0.10 0.100 | 2.40 Min 0.095 Min | 0.65 22 AWG | 2.60 | 270 | 380 | 345 | 250 |
| 2952778301 | 3 | 11.20 -0.50 0.430 | 11.20 -0.50 0.430 | 11.80 Max 0.464 Max | 2.54 ±0.10 0.100 | 7.60 ±0.20 0.300 | 2.40 Min 0.095 Min | 0.65 22 AWG | 6.00 | 320 | 460 | 395 | 300 |

Fair-Rite Products Corp. PO Box 288, One Commercial Row, Wallkill, NY 12589-0288

Phone: (888) FAIR RITE / (845) 895-2055 • Fax: (888) FERRITE / (845) 895-2629 • Web: www.fair-rite.com
 (888) 324-7748 (888) 337-7483 E -mail: ferrites@fair-rite.com

Quick Link: www.fair-rite.com/wb

Six and eleven hole beads, in two NiZn materials, are available both as beads (product class 26) and wound with tinned copper wire in several winding configurations (product class 29).

- Parts with a “1” as the last digit of the part number are supplied bulk packed. Wound beads with part numbers 29--666631 and 29--666651 can be supplied radially taped and reeled per IEC 60286-1 and EIA 468-B standards. For these taped and reeled wound beads the last digit of the part number is a “4”. Taped and reeled wound beads are supplied 500 pieces on a 13” reel.
- Wire used for winding is oxygen free high conductivity copper with 100% matte tin plating over a nickel undercoating.
- Beads are controlled for impedance limits only. Minimum impedance values are specified for the + marked frequencies. The minimum impedance is typically the listed impedance less 20%. The 44 material beads and wound beads are tested on the 4193A Vector Impedance Meter. The 61 material parts on the 4291A RF Impedance Analyzer.
- Recommended storage temperature and operating temperature is -55 °C to 125 °C
- Performance curves for these suppression components are on our web site.
- For any wound bead requirement not listed in here, please contact our customer service group for availability and pricing.
- Explanation of Part Numbers: Digits 1&2 = product class, 3&4 = material grade and last digit 1 = bulk packed, 4 = taped and reeled.

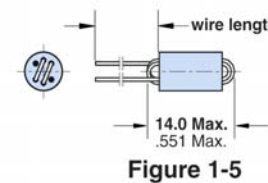
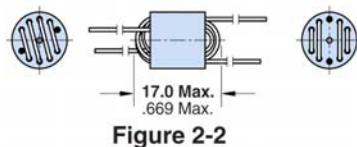
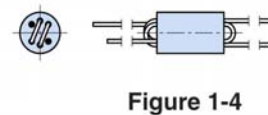
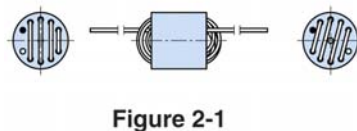
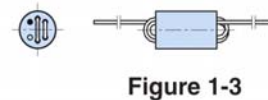
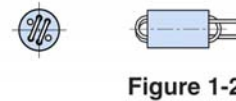
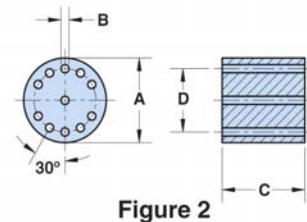
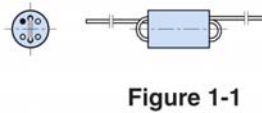
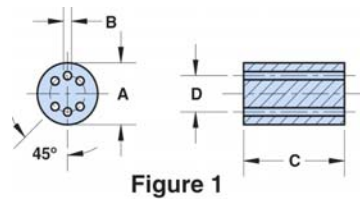

Quick Link: www.fair-rite.com/wb

Legend

Dimensions (Top numbers are in millimeters, bottom numbers are in nominal inches.)

* Test frequency

A1/2 turn is defined as a single pass through a hole.

Beads

| Part Number | Fig. | Turns Tested | A | B | C | D | Wt. (g) | Impedance (Ω) | | | |
|-------------|------|--------------|----------------------|---------------------|----------------------|-----------------------|---------|---------------------|---------------------|----------------------|----------------------|
| | | | | | | | | 10 MHz ⁺ | 50 MHz ⁺ | 100 MHz ⁺ | 200 MHz ⁺ |
| 2644666611 | 1 | 1½ | 6.00 ±0.25 0.236 | 0.75 +0.15 0.032 | 10.00 ±0.25 0.394 | 3.50 Ref 0.138 Ref | 1.20 | 213 | 400 | 470 | - |
| 2661666611 | 1 | 1½ | 6.00 ±0.25 0.236 | 0.75 +0.15 0.032 | 10.00 ±0.25 0.394 | 3.50 Ref 0.138 Ref | 1.20 | - | 280 | 380 | 510 |
| 2644777711 | 2 | 2½ | 10.00 ±0.25 0.394 | 0.90 +0.15 0.038 | 10.00 ±0.25 0.394 | 7.50 Ref 0.295 Ref | 3.30 | 375 | 905 | 500 | - |

Broadband Frequencies 1-200 MHz (44 material)

| Row # | Part Number | Fig. | A | B | C | D | Wt. (g) | Reel Information | |
|-------|-------------|------|----------------------|---------------------|----------------------|-----------------------|---------|------------------|----------------|
| | | | | | | | | Pitch mm | Parts 13" Reel |
| (1) | 2944666661 | 1-1 | 6.00 ±0.25 0.236 | 0.75 +0.15 0.032 | 10.00 ±0.25 0.394 | 3.50 Ref 0.138 Ref | 1.30 | - | - |
| (2) | 2944666651 | 1-2 | 6.00 ±0.25 0.236 | 0.75 +0.15 0.032 | 10.00 ±0.25 0.394 | 3.50 Ref 0.138 Ref | 1.30 | - | - |
| (3) | 2944666654 | 1-2 | 6.00 ±0.25 0.236 | 0.75 +0.15 0.032 | 10.00 ±0.25 0.394 | 3.50 Ref 0.138 Ref | 1.30 | 12.7 | 500 |
| (4) | 2944666671 | 1-3 | 6.00 ±0.25 0.236 | 0.75 +0.15 0.032 | 10.00 ±0.25 0.394 | 3.50 Ref 0.138 Ref | 1.40 | - | - |
| (5) | 2944666681 | 1-4 | 6.00 ±0.25 0.236 | 0.75 +0.15 0.032 | 10.00 ±0.25 0.394 | 3.50 Ref 0.138 Ref | 1.40 | - | - |
| (6) | 2944666631 | 1-5 | 6.00 ±0.25 0.236 | 0.75 +0.15 0.032 | 10.00 ±0.25 0.394 | 3.50 Ref 0.138 Ref | 1.40 | - | - |
| (7) | 2944666634 | 1-5 | 6.00 ±0.25 0.236 | 0.75 +0.15 0.032 | 10.00 ±0.25 0.394 | 3.50 Ref 0.138 Ref | 1.40 | 12.7 | 500 |
| (8) | 2944777741 | 2-1 | 10.00 ±0.25 0.394 | 0.90 +0.15 0.038 | 10.00 ±0.25 0.394 | 7.50 Ref 0.295 Ref | 3.80 | - | - |
| (9) | 2944777721 | 2-2 | 10.00 ±0.25 0.394 | 0.90 +0.15 0.038 | 10.00 ±0.25 0.394 | 7.50 Ref 0.295 Ref | 3.90 | - | - |

Table Continued ...

| Row # | Part Number | Turns | Wire Size | 1st Wire Length | 2nd Wire Length | Impedance (Ω) | | | | |
|-------|-------------|--------|----------------|--------------------|--------------------|---------------|---------------------|---------------------|----------------------|---------|
| | | | | | | 1 MHz | 10 MHz ⁺ | 50 MHz ⁺ | 100 MHz ⁺ | 200 MHz |
| (1) | 2944666661 | 1½ | 0.53 24 AWG | 38.0 ±3.0 1.500 | - | 45 | 213 | 400 | 470 | 380 |
| (2) | 2944666651 | 2 | 0.53 24 AWG | 38.0 ±3.0 1.500 | - | 58 | 300 | 650 | 600 | 415 |
| (3) | 2944666654 | 2 | 0.53 24 AWG | 38.0 ±3.0 1.500 | - | 58 | 300 | 650 | 600 | 415 |
| (4) | 2944666671 | 2½ | 0.53 24 AWG | 38.0 ±3.0 1.500 | - | 87 | 400 | 850 | 725 | 410 |
| (5) | 2944666681 | 2 x 1½ | 0.53 24 AWG | 38.0 ±3.0 1.500 | 28.0 ±3.0 1.102 | 45 | 213 | 400 | 470 | 380 |
| (6) | 2944666631 | 3 | 0.53 24 AWG | 38.0 ±3.0 1.500 | - | 115 | 500 | 1000 | 690 | 400 |

Quick Link: www.fair-rite.com/wb

Table Continued ...

| Row # | Part Number | Turns | Wire Size | 1st Wire Length | 2nd Wire Length | Impedance (Ω) | | | | |
|-------|-------------|--------|----------------|-------------------------|-------------------------|------------------------|---------------------|---------------------|----------------------|---------|
| | | | | | | 1 MHz | 10 MHz ⁺ | 50 MHz ⁺ | 100 MHz ⁺ | 200 MHz |
| (7) | 2944666634 | 3 | 0.53 24 AWG | 38.0 \pm 3.0 1.500 | – | 115 | 500 | 1000 | 690 | 400 |
| (8) | 2944777741 | 4½ | 0.65 22 AWG | 38.0 \pm 3.0 1.500 | – | 150 | 815 | 1250 | 500 | 375 |
| (9) | 2944777721 | 2 x 2½ | 0.65 22 AWG | 38.0 \pm 3.0 1.500 | 28.0 \pm 3.0 1.102 | 45 | 375 | 905 | 500 | 400 |

Higher Frequencies 50-500 MHz (61 material)

| Row # | Part Number | Fig. | A | B | C | D | Wt. (g) | Reel Information | |
|-------|-------------|------|--------------------------|--------------------------|---------------------------|-----------------------|---------|------------------|----------------|
| | | | | | | | | Pitch mm | Parts 13" Reel |
| (10) | 2961666661 | 1-1 | 6.00 \pm 0.25 0.236 | 0.75 \pm 0.15 0.032 | 10.00 \pm 0.25 0.394 | 3.50 Ref 0.138 Ref | 1.30 | - | - |
| (11) | 2961666651 | 1-2 | 6.00 \pm 0.25 0.236 | 0.75 \pm 0.15 0.032 | 10.00 \pm 0.25 0.394 | 3.50 Ref 0.138 Ref | 1.30 | - | - |
| (12) | 2961666654 | 1-2 | 6.00 \pm 0.25 0.236 | 0.75 \pm 0.15 0.032 | 10.00 \pm 0.25 0.394 | 3.50 Ref 0.138 Ref | 1.30 | 12.7 | 500 |
| (13) | 2961666671 | 1-3 | 6.00 \pm 0.25 0.236 | 0.75 \pm 0.15 0.032 | 10.00 \pm 0.25 0.394 | 3.50 Ref 0.138 Ref | 1.40 | - | - |
| (14) | 2961666681 | 1-4 | 6.00 \pm 0.25 0.236 | 0.75 \pm 0.15 0.032 | 10.00 \pm 0.25 0.394 | 3.50 Ref 0.138 Ref | 1.40 | - | - |
| (15) | 2961666631 | 1-5 | 6.00 \pm 0.25 0.236 | 0.75 \pm 0.15 0.032 | 10.00 \pm 0.25 0.394 | 3.50 Ref 0.138 Ref | 1.40 | - | - |
| (16) | 2961666634 | 1-5 | 6.00 \pm 0.25 0.236 | 0.75 \pm 0.15 0.032 | 10.00 \pm 0.25 0.394 | 3.50 Ref 0.138 Ref | 1.40 | 12.7 | 500 |

Table Continued ...

| Row # | Part Number | Turns | Wire Size | 1st Wire Length | 2nd Wire Length | Impedance (Ω) | | | | |
|-------|-------------|--------|----------------|-------------------------|-------------------------|------------------------|---------------------|----------------------|----------------------|---------|
| | | | | | | 10 MHz | 50 MHz ⁺ | 100 MHz ⁺ | 200 MHz ⁺ | 400 MHz |
| (10) | 2961666661 | 1½ | 0.53 24 AWG | 38.0 \pm 3.0 1.500 | – | 75 | 280 | 380 | 510 | 600 |
| (11) | 2961666651 | 2 | 0.53 24 AWG | 38.0 \pm 3.0 1.500 | – | 100 | 400 | 560 | 760 | 700 |
| (12) | 2961666654 | 2 | 0.53 24 AWG | 38.0 \pm 3.0 1.500 | – | 100 | 400 | 560 | 760 | 700 |
| (13) | 2961666671 | 2½ | 0.53 24 AWG | 38.0 \pm 3.0 1.500 | – | 150 | 560 | 780 | 960 | 600 |
| (14) | 2961666681 | 2 x 1½ | 0.53 24 AWG | 38.0 \pm 3.0 1.500 | 28.0 \pm 3.0 1.102 | 75 | 280 | 380 | 510 | 600 |
| (15) | 2961666631 | 3 | 0.53 24 AWG | 38.0 \pm 3.0 1.500 | – | 175 | 700 | 1000 | 1100 | 625 |
| (16) | 2961666634 | 3 | 0.53 24 AWG | 38.0 \pm 3.0 1.500 | – | 175 | 700 | 1000 | 1100 | 625 |

Quick Link: www.fair-rite.com/mac

Multi-aperture cores are used in suppression applications and in balun (balance-unbalance) and other broadband transformers. They are also employed in airbag designs to prevent accidental activation.

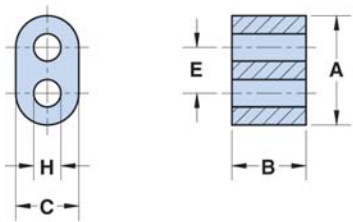

Figure 1

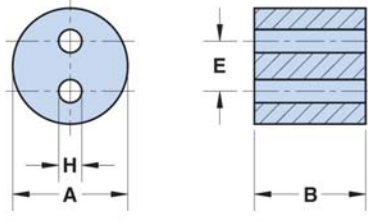

Figure 2

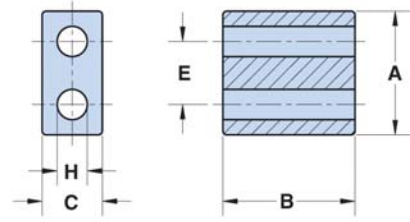

Figure 3

- All multi-aperture cores are supplied burnished.
- Multi-aperture cores in 73 and 43 materials are controlled for impedance only. The 61 NiZn material is controlled for both impedance and AL value. The high frequency 67 material is controlled for AL value. Minimum impedance values are specified for the + marked frequencies. The minimum impedance is typically the listed impedance less 20%.
- Multi-aperture cores in 73 and 43 material are measured for impedance on the 4193A Vector Impedance Analyzer. The 61 and 67 multi-aperture cores are tested on the 4291A Impedance Analyzer. All impedance measurements are performed with a single turn to both holes, **using the shortest practical wire length**.
- The 61 and 67 material multi-hole beads are tested for AL value. The test frequency is 10 kHz at < 10 gauss. The test winding is five turns wound through both holes.
- Performance curves for these suppression components are on our web site.
- For any multi-aperture requirement not listed here, feel free to contact our customer service group for availability and pricing.
- Our "Multi-Aperture Core Kit" (part number 0199000036) is available for prototype evaluation.
- Explanation of Part Numbers: Digits 1&2 = product class, 3&4 = material grade last digit 2 = burnished.

Multi-Aperture Cores



Quick Link: www.fair-rite.com/mac

Legend

Dimensions (Top numbers are in millimeters, bottom numbers are in nominal inches.)

+ Test frequency

Suppression Applications for Lower Frequencies < 50 MHz (73 material)

| Part Number | Fig. | A | B | C | E | H | Wt. (g) | Impedance (Ω) | |
|-------------|------|---------------------------|---------------------------|--------------------------|--------------------------|--------------------------|---------|------------------------|---------------------|
| | | | | | | | | 10 MHz | 25 MHz ⁺ |
| 2873002302 | 1 | 3.45 \pm 0.25 0.136 | 2.35 \pm 0.25 0.093 | 2.00 \pm 0.15 0.079 | 1.45 \pm 0.10 0.057 | 0.75 \pm 0.25 0.034 | 0.10 | 35 | 44 |
| 2873002702 | 1 | 7.00 \pm 0.25 0.276 | 3.10 \pm 0.25 0.122 | 4.20 -0.25 0.160 | 2.90 \pm 0.10 0.114 | 1.70 \pm 0.20 0.071 | 0.30 | 28 | 38 |
| 2873002402 | 1 | 7.00 \pm 0.25 0.276 | 6.20 \pm 0.25 0.244 | 4.20 -0.25 0.160 | 2.90 \pm 0.10 0.114 | 1.70 \pm 0.20 0.071 | 0.50 | 80 | 75 |
| 2873001802 | 2 | 6.35 \pm 0.25 0.250 | 6.15 \pm 0.25 0.242 | – | 2.75 \pm 0.20 0.108 | 1.10 \pm 0.30 0.050 | 0.80 | 115 | 106 |
| 2873001702 | 2 | 6.35 \pm 0.25 0.250 | 12.00 \pm 0.35 0.471 | – | 2.75 \pm 0.20 0.108 | 1.10 \pm 0.30 0.050 | 1.60 | 200 | 200 |
| 2873001502 | 1 | 13.30 \pm 0.60 0.525 | 6.60 \pm 0.25 0.260 | 7.50 \pm 0.35 0.295 | 5.70 \pm 0.25 0.225 | 3.80 \pm 0.25 0.150 | 1.70 | 57 | 50 |
| 2873000302 | 1 | 13.30 \pm 0.60 0.525 | 10.30 \pm 0.30 0.407 | 7.50 \pm 0.35 0.295 | 5.70 \pm 0.25 0.225 | 3.80 \pm 0.25 0.150 | 2.60 | 94 | 75 |
| 2873000102 | 1 | 13.30 \pm 0.60 0.525 | 13.40 \pm 0.30 0.528 | 7.50 \pm 0.35 0.295 | 5.70 \pm 0.25 0.225 | 3.80 \pm 0.25 0.150 | 3.50 | 127 | 93 |
| 2873000202 | 1 | 13.30 \pm 0.60 0.525 | 14.35 \pm 0.50 0.565 | 7.50 \pm 0.35 0.295 | 5.70 \pm 0.25 0.225 | 3.80 \pm 0.25 0.150 | 3.70 | 125 | 106 |
| 2873006802 | 1 | 13.30 \pm 0.60 0.525 | 27.00 \pm 0.75 1.062 | 7.50 \pm 0.35 0.295 | 5.70 \pm 0.25 0.225 | 3.80 \pm 0.25 0.150 | 7.00 | 195 | 180 |

Suppression Applications for Broadband Frequencies 20-300 MHz (43 material)

| Part Number | Fig. | A | B | C | E | H | Wt. (g) | Impedance (Ω) | |
|-------------|------|---------------------------|---------------------------|---------------------------|---------------------------|--------------------------|---------|------------------------|----------------------|
| | | | | | | | | 25 MHz | 100 MHz ⁺ |
| 2843002302 | 1 | 3.45 \pm 0.25 0.136 | 2.35 \pm 0.25 0.093 | 2.00 \pm 0.15 0.079 | 1.45 \pm 0.10 0.057 | 0.75 \pm 0.25 0.034 | 0.10 | 29 | 44 |
| 2843002702 | 1 | 7.00 \pm 0.25 0.276 | 3.10 \pm 0.25 0.122 | 4.20 -0.25 0.160 | 2.90 \pm 0.10 0.114 | 1.70 \pm 0.20 0.071 | 0.30 | 37 | 50 |
| 2843002402 | 1 | 7.00 \pm 0.25 0.276 | 6.20 \pm 0.25 0.244 | 4.20 -0.25 0.160 | 2.90 \pm 0.10 0.114 | 1.70 \pm 0.20 0.071 | 0.50 | 74 | 100 |
| 2843001802 | 2 | 6.35 \pm 0.25 0.250 | 6.15 \pm 0.25 0.242 | – | 2.75 \pm 0.20 0.108 | 1.10 \pm 0.30 0.050 | 0.80 | 100 | 131 |
| 2843001502 | 1 | 13.30 \pm 0.60 0.525 | 6.60 \pm 0.25 0.260 | 7.50 \pm 0.35 0.295 | 5.70 \pm 0.25 0.225 | 3.80 \pm 0.25 0.150 | 1.70 | 59 | 88 |
| 2843000302 | 1 | 13.30 \pm 0.60 0.525 | 10.30 \pm 0.30 0.407 | 7.50 \pm 0.35 0.295 | 5.70 \pm 0.25 0.225 | 3.80 \pm 0.25 0.150 | 2.60 | 104 | 130 |
| 2843000102 | 1 | 13.30 \pm 0.60 0.525 | 13.40 \pm 0.30 0.528 | 7.50 \pm 0.35 0.295 | 5.70 \pm 0.25 0.225 | 3.80 \pm 0.25 0.150 | 3.50 | 122 | 175 |
| 2843000202 | 1 | 13.30 \pm 0.60 0.525 | 14.35 \pm 0.50 0.565 | 7.50 \pm 0.35 0.295 | 5.70 \pm 0.25 0.225 | 3.80 \pm 0.25 0.150 | 3.70 | 123 | 180 |
| 2843006802 | 1 | 13.30 \pm 0.60 0.525 | 27.00 \pm 0.75 1.062 | 7.50 \pm 0.35 0.295 | 5.70 \pm 0.25 0.225 | 3.80 \pm 0.25 0.150 | 7.00 | 219 | 300 |
| 2843010402 | 3 | 19.45 \pm 0.40 0.765 | 12.70 \pm 0.50 0.500 | 9.50 \pm 0.25 0.375 | 9.90 \pm 0.25 0.390 | 4.75 \pm 0.20 0.187 | 7.50 | 135 | 200 |
| 2843010302 | 3 | 19.45 \pm 0.40 0.765 | 25.40 \pm 0.70 1.000 | 9.50 \pm 0.25 0.375 | 9.90 \pm 0.25 0.390 | 4.75 \pm 0.20 0.187 | 18.00 | 295 | 400 |
| 2843009902 | 3 | 28.70 \pm 0.60 1.130 | 28.70 \pm 0.70 1.130 | 14.25 \pm 0.30 0.560 | 14.00 \pm 0.30 0.550 | 6.35 \pm 0.15 0.250 | 48.00 | 380 | 500 |

Fair-Rite Products Corp. PO Box 288, One Commercial Row, Wallkill, NY 12589-0288

Quick Link: www.fair-rite.com/mac

Suppression Applications for Higher Frequencies > 250 MHz (61 material) Broadband and Inductive Designs 1- 40 MHz (61 material)

| Part Number | Fig. | A | B | C | E | H | Wt. (g) | Impedance (Ω) | | A_L (nH) |
|-------------|------|----------------------|----------------------|----------------------|----------------------|---------------------|---------|------------------------|----------------------|------------|
| | | | | | | | | 100 MHz | 250 MHz ⁺ | |
| 2861002302 | 1 | 3.45 ±0.25 0.136 | 2.35 ±0.25 0.093 | 2.00 ±0.15 0.079 | 1.45 ±0.10 0.057 | 0.75 +0.25 0.034 | 0.10 | 35 | 48 | 60 Min |
| 2861002702 | 1 | 7.00 ±0.25 0.276 | 3.10 ±0.25 0.122 | 4.20 -0.25 0.160 | 2.90 ±0.10 0.114 | 1.70 +0.20 0.071 | 0.30 | 44 | 63 | 80 Min |
| 2861002402 | 1 | 7.00 ±0.25 0.276 | 6.20 ±0.25 0.244 | 4.20 -0.25 0.160 | 2.90 ±0.10 0.114 | 1.70 +0.20 0.071 | 0.50 | 80 | 118 | 160 Min |
| 2861001702 | 2 | 6.35 ±0.25 0.250 | 12.00 ±0.35 0.471 | - | 2.75 ±0.20 0.108 | 1.10 +0.30 0.050 | 1.60 | 210 | 275 | 440 Min |
| 2861001502 | 1 | 13.30 ±0.60 0.525 | 6.60 ±0.25 0.260 | 7.50 ±0.35 0.295 | 5.70 ±0.25 0.225 | 3.80 ±0.25 0.150 | 1.70 | 90 | 115 | 145 Min |
| 2861000302 | 1 | 13.30 ±0.60 0.525 | 10.30 ±0.30 0.407 | 7.50 ±0.35 0.295 | 5.70 ±0.25 0.225 | 3.80 ±0.25 0.150 | 2.60 | 150 | 200 | 230 Min |
| 2861000102 | 1 | 13.30 ±0.60 0.525 | 13.40 ±0.30 0.528 | 7.50 ±0.35 0.295 | 5.70 ±0.25 0.225 | 3.80 ±0.25 0.150 | 3.50 | 160 | 225 | 300 Min |
| 2861000202 | 1 | 13.30 ±0.60 0.525 | 14.35 ±0.50 0.565 | 7.50 ±0.35 0.295 | 5.70 ±0.25 0.225 | 3.80 ±0.25 0.150 | 3.70 | 150 | 190 | 320 Min |
| 2861006802 | 1 | 13.30 ±0.60 0.525 | 27.00 ±0.75 1.062 | 7.50 ±0.35 0.295 | 5.70 ±0.25 0.225 | 3.80 ±0.25 0.150 | 7.00 | 300 | 425 | 600 Min |
| 2861010002 | 3 | 30.20 ±0.60 1.190 | 28.70 ±0.70 1.130 | 15.00 ±0.40 0.590 | 14.60 ±0.40 0.575 | 6.80 ±0.2 0.268 | 46.00 | 510 | 625 | 800 Min |

Broadband and Inductive Designs 10-100 MHz (67 material)

| Part Number | Fig. | A | B | C | E | H | Wt. (g) | A_L (nH) |
|-------------|------|----------------------|----------------------|---------------------|---------------------|---------------------|---------|------------|
| 2867002302 | 1 | 3.45 ±0.25 0.136 | 2.35 ±0.25 0.093 | 2.00 ±0.15 0.079 | 1.45 ±0.10 0.057 | 0.75 +0.25 0.034 | 0.10 | 18 Min |
| 2867002702 | 1 | 7.00 ±0.25 0.276 | 3.10 ±0.25 0.122 | 4.20 -0.25 0.160 | 2.90 ±0.10 0.114 | 1.70 +0.20 0.071 | 0.30 | 24 Min |
| 2867002402 | 1 | 7.00 ±0.25 0.276 | 6.20 ±0.25 0.244 | 4.20 -0.25 0.160 | 2.90 ±0.10 0.114 | 1.70 +0.20 0.071 | 0.50 | 48 Min |
| 2867001502 | 1 | 13.30 ±0.60 0.525 | 6.60 ±0.25 0.260 | 7.50 ±0.35 0.295 | 5.70 ±0.25 0.225 | 3.80 ±0.25 0.150 | 1.70 | 44 Min |
| 2867000302 | 1 | 13.30 ±0.60 0.525 | 10.30 ±0.30 0.407 | 7.50 ±0.35 0.295 | 5.70 ±0.25 0.225 | 3.80 ±0.25 0.150 | 2.60 | 68 Min |
| 2867000102 | 1 | 13.30 ±0.60 0.525 | 13.40 ±0.30 0.528 | 7.50 ±0.35 0.295 | 5.70 ±0.25 0.225 | 3.80 ±0.25 0.150 | 3.50 | 89 Min |
| 2867006802 | 1 | 13.30 ±0.60 0.525 | 27.00 ±0.75 1.062 | 7.50 ±0.35 0.295 | 5.70 ±0.25 0.225 | 3.80 ±0.25 0.150 | 7.00 | 180 Min |

Quick Link: www.fair-rite.com/sbd

Surface mount beads are available from Fair-Rite in several materials and sizes. Their rugged construction lowers the dc resistance and increases current carrying capacity compared to plated beads.

- SM Beads on 12 mm tape width are supplied taped and reeled per EIA 481-1 and IEC 60286-3 standards. SM Beads on 16 and 24 mm tape widths are supplied taped and reeled per EIA 481-2 and IEC 60286-3 standards. Taped and reeled parts are supplied on a 13" reel.
- SM Beads can also be supplied not taped and reeled and then are bulk packed. This packing method will change the last digit of the part number to a "6".
- Wires are oxygen free high conductivity copper with 100% matte tin plating over a nickel undercoating.
- SM Beads meet the solderability specifications when tested in accordance with MIL-STD-202, method 208. After dipping the mounting site of the bead, the solder surface shall be at least 95% covered with a smooth solder coating. The edges of the copper strip are not specified as solderable surfaces.
- After preheating the beads to within 100 °C of the soldering temperature, the parts meet the resistance to soldering requirements of EIA-186-10E, temperature 260 ±5 °C and time 10 ±1 seconds.
- Suggested land patterns are in accordance with the latest revision of IPC-7351.
- SM Beads are controlled for impedance limits only. Minimum impedance values are specified for the + marked frequencies. The minimum impedance is typically the listed value less 20%. SM Beads in 73, 43 and 44 materials are measured for impedance on the 4193 Vector Impedance Analyzer. The 52 and 61 SM Beads are tested for impedance on the 4291A RF Impedance Analyzer.
- Recommended storage and operation temperature is -55 °C to 125 °C.
- The maximum practical current rating for these SM Beads is 5 amps, check the component bias curves. The 019/021/037 and 044 SM Beads can withstand a continuous current of 10 amps resulting in a component temperature rise < 40 °C
- Performance curves for these suppression components are on our web site.
- For any SM Bead requirement not listed, please contact our customer service group for availability and pricing.
- Our "Surface Mount Bead Kit" (part number 0199000025) is available for prototype evaluation.
- Explanation of Part Numbers: Digits 1&2 = product class, 3&4 = material grade, last digit 6 = bulk packed, 7 = taped and reeled.

SM Beads (Differential-Mode)



Quick Link: www.fair-rite.com/sbd

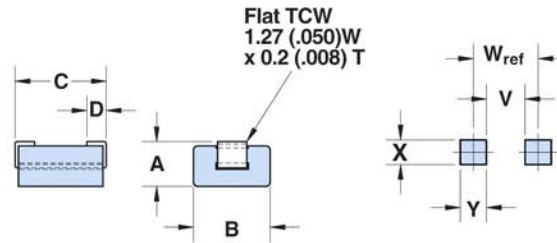

Figure 1

Land Pattern
for Fig. 1

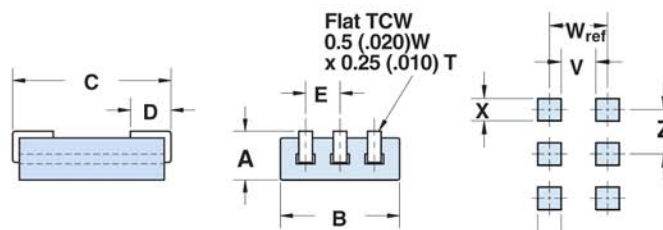

Figure 2

Land Pattern
for Fig. 2
E = Z

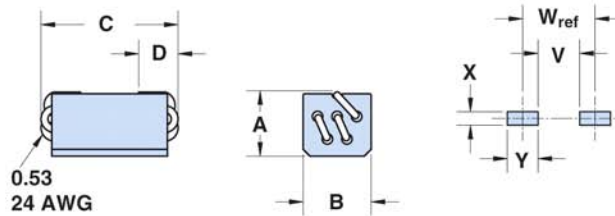

Figure 3

Land Pattern
for Fig. 3

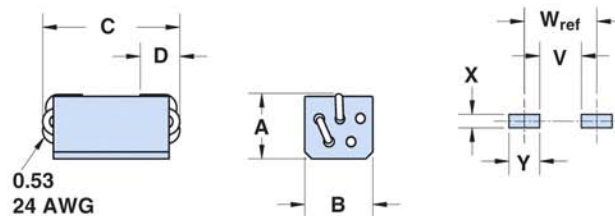

Figure 4

Land Pattern
for Fig. 4

SM Beads (Differential-Mode)



Quick Link: www.fair-rite.com/sbd

Legend

Dimensions (Top numbers are in millimeters, bottom numbers are in nominal inches.)

+ Test frequency

Lower Frequencies < 50 MHz (73 material)

| Row # | Part Number | Fig. | A | B | C | D | Wt. (g) | Reel Information | | |
|-------|-------------|------|-----------------------|---------------------|---------------------|---------------------|---------|------------------|----------|----------------|
| | | | | | | | | Tape Width mm | Pitch mm | Parts 13" Reel |
| (1) | 2773019447 | 1 | 2.85 ±0.20 0.112 | 3.05 ±0.10 0.120 | 5.10 -0.85 0.184 | 1.50 ±0.50 0.059 | 0.15 | 12 | 8 | 2800 |
| (2) | 2773019446 | 1 | 2.85 ±0.20 0.112 | 3.05 ±0.10 0.120 | 5.10 -0.85 0.184 | 1.50 ±0.50 0.059 | 0.15 | - | - | - |
| (3) | 2773021447 | 1 | 2.85 ±0.20 0.112 | 3.05 ±0.10 0.120 | 9.60 -0.95 0.359 | 1.50 ±0.50 0.059 | 0.30 | 16 | 8 | 2800 |
| (4) | 2773021446 | 1 | 2.85 ±0.20 0.112 | 3.05 ±0.10 0.120 | 9.60 -0.95 0.359 | 1.50 ±0.50 0.059 | 0.30 | - | - | - |
| (5) | 2773037447 | 1 | 2.70 ±0.20 0.106 | 4.60 ±0.20 0.181 | 9.25 -0.70 0.350 | 1.40 ±0.40 0.055 | 0.45 | 16 | 8 | 2800 |
| (6) | 2773037446 | 1 | 2.70 ±0.20 0.106 | 4.60 ±0.20 0.181 | 9.25 -0.70 0.350 | 1.40 ±0.40 0.055 | 0.45 | - | - | - |
| (7) | 2773044447 | 1 | 1.75 Max 0.068 Max | 3.10 ±0.10 0.122 | 5.65 ±0.45 0.222 | 1.55 ±0.50 0.061 | 0.09 | 12 | 8 | 4500 |
| (8) | 2773044446 | 1 | 1.75 Max 0.068 Max | 3.10 ±0.10 0.122 | 5.65 ±0.45 0.222 | 1.55 ±0.50 0.061 | 0.09 | - | - | - |

Table Continued ...

| Row # | Part Number | Impedance (Ω) | | | | Max Rdc (mΩ) | Land Patterns | | | | |
|-------|-------------|---------------|-------|---------------------|---------------------|--------------|---------------|---------------|---------------|---------------|---|
| | | 1 MHz | 5 MHz | 10 MHz ⁺ | 25 MHz ⁺ | | V | W (ref) | X | Y | Z |
| (1) | 2773019447 | 12 | 25 | 31 | 40 | 0.80 | 1.00 0.040 | 4.00 0.157 | 1.80 0.071 | 3.00 0.118 | - |
| (2) | 2773019446 | 12 | 25 | 31 | 40 | 0.80 | 1.00 0.040 | 4.00 0.157 | 1.80 0.071 | 3.00 0.118 | - |
| (3) | 2773021447 | 25 | 50 | 60 | 78 | 1.20 | 4.50 0.177 | 7.50 0.295 | 1.80 0.071 | 3.00 0.118 | - |
| (4) | 2773021446 | 25 | 50 | 60 | 78 | 1.20 | 4.50 0.177 | 7.50 0.295 | 1.80 0.071 | 3.00 0.118 | - |
| (5) | 2773037447 | 25 | 50 | 60 | 78 | 1.20 | 5.00 0.197 | 8.00 0.315 | 1.80 0.071 | 3.00 0.118 | - |
| (6) | 2773037446 | 25 | 50 | 60 | 78 | 1.20 | 5.00 0.197 | 8.00 0.315 | 1.80 0.071 | 3.00 0.118 | - |
| (7) | 2773044447 | 9 | 19 | 25 | 33 | 1.10 | 1.50 0.059 | 4.50 0.177 | 1.80 0.071 | 3.00 0.118 | - |
| (8) | 2773044446 | 9 | 19 | 25 | 33 | 1.10 | 1.50 0.059 | 4.50 0.177 | 1.80 0.071 | 3.00 0.118 | - |

Fair-Rite Products Corp. PO Box 288, One Commercial Row, Wallkill, NY 12589-0288

SM Beads (Differential-Mode)



Quick Link: www.fair-rite.com/sbd

Broadband Frequencies 25-300 MHz (43 & 44 materials)

| Row # | Part Number | Fig. | A | B | C | D | E | Wt. (g) | Reel Information | | |
|-------|-------------|------|-----------------------|---------------------|------------------------|---------------------|---------------------|---------|------------------|----------|----------------|
| | | | | | | | | | Tape Width mm | Pitch mm | Parts 13" Reel |
| (9) | 2743019447 | 1 | 2.85 ±0.20 0.112 | 3.05 ±0.10 0.120 | 5.10 -0.85 0.184 | 1.50 ±0.50 0.059 | - | 0.15 | 12 | 8 | 2800 |
| (10) | 2743019446 | 1 | 2.85 ±0.20 0.112 | 3.05 ±0.10 0.120 | 5.10 -0.85 0.184 | 1.50 ±0.50 0.059 | - | 0.15 | - | - | - |
| (11) | 2743021447 | 1 | 2.85 ±0.20 0.112 | 3.05 ±0.10 0.120 | 9.60 -0.95 0.359 | 1.50 ±0.50 0.059 | - | 0.30 | 16 | 8 | 2800 |
| (12) | 2743021446 | 1 | 2.85 ±0.20 0.112 | 3.05 ±0.10 0.120 | 9.60 -0.95 0.359 | 1.50 ±0.50 0.059 | - | 0.30 | - | - | - |
| (13) | 2743037447 | 1 | 2.70 ±0.20 0.106 | 4.60 ±0.20 0.181 | 9.25 -0.70 0.350 | 1.40 ±0.40 0.055 | - | 0.45 | 16 | 8 | 2800 |
| (14) | 2743037446 | 1 | 2.70 ±0.20 0.106 | 4.60 ±0.20 0.181 | 9.25 -0.70 0.350 | 1.40 ±0.40 0.055 | - | 0.45 | - | - | - |
| (15) | 2744044447 | 1 | 1.75 Max 0.068 Max | 3.10 ±0.10 0.122 | 5.65 ±0.45 0.222 | 1.55 ±0.50 0.061 | - | 0.09 | 12 | 8 | 4500 |
| (16) | 2744044446 | 1 | 1.75 Max 0.068 Max | 3.10 ±0.10 0.122 | 5.65 ±0.45 0.222 | 1.55 ±0.50 0.061 | - | 0.09 | - | - | - |
| (17) | 2744040447 | 2 | 1.95 Max 0.076 Max | 4.50 ±0.20 0.177 | 6.40 -0.60 0.240 | 1.40 ±0.40 0.055 | 1.27 ±0.05 0.050 | 0.14 | 12 | 8 | 4000 |
| (18) | 2744040446 | 2 | 1.95 Max 0.076 Max | 4.50 ±0.20 0.177 | 6.40 -0.60 0.240 | 1.40 ±0.40 0.055 | 1.27 ±0.05 0.050 | 0.14 | - | - | - |
| (19) | 2744555567 | 4 | 5.00 Max 0.197 Max | 5.00 ±0.25 0.197 | 11.00 Max 0.433 Max | 2.50 ±0.50 0.098 | - | 0.96 | 24 | 12 | 1500 |
| (20) | 2744555566 | 4 | 5.00 Max 0.197 Max | 5.00 ±0.25 0.197 | 11.00 Max 0.433 Max | 2.50 ±0.50 0.098 | - | 0.96 | - | - | - |
| (21) | 2744555577 | 3 | 5.00 Max 0.197 Max | 5.00 ±0.25 0.197 | 11.00 Max 0.433 Max | 2.50 ±0.50 0.098 | - | 0.96 | 24 | 12 | 1500 |
| (22) | 2744555576 | 3 | 5.00 Max 0.197 Max | 5.00 ±0.25 0.197 | 11.00 Max 0.433 Max | 2.50 ±0.50 0.098 | - | 0.96 | - | - | - |

Table Continued ...

| Row # | Part Number | Impedance (Ω) | | | | Max Rdc (mΩ) | Land Patterns | | | | |
|-------|-------------|---------------|---------------------|----------------------|---------|--------------|---------------|---------------|---------------|---------------|---------------|
| | | 10 MHz | 25 MHz ⁺ | 100 MHz ⁺ | 250 MHz | | V | W (ref) | X | Y | Z |
| (9) | 2743019447 | 18 | 29 | 47 | 49 | 0.80 | 1.00 0.040 | 4.00 0.157 | 1.80 0.071 | 3.00 0.118 | - |
| (10) | 2743019446 | 18 | 29 | 47 | 49 | 0.80 | 1.00 0.040 | 4.00 0.157 | 1.80 0.071 | 3.00 0.118 | - |
| (11) | 2743021447 | 37 | 56 | 95 | 100 | 1.20 | 4.50 0.177 | 7.50 0.295 | 1.80 0.071 | 3.00 0.118 | - |
| (12) | 2743021446 | 37 | 56 | 95 | 100 | 1.20 | 4.50 0.177 | 7.50 0.295 | 1.80 0.071 | 3.00 0.118 | - |
| (13) | 2743037447 | 37 | 56 | 95 | 100 | 1.20 | 5.00 0.197 | 8.00 0.315 | 1.80 0.071 | 3.00 0.118 | - |
| (14) | 2743037446 | 37 | 56 | 95 | 100 | 1.20 | 5.00 0.197 | 8.00 0.315 | 1.80 0.071 | 3.00 0.118 | - |
| (15) | 2744044447 | 13 | 21 | 36 | 39 | 1.10 | 1.50 0.059 | 4.50 0.177 | 1.80 0.071 | 3.00 0.118 | - |
| (16) | 2744044446 | 13 | 21 | 36 | 39 | 1.10 | 1.50 0.059 | 4.50 0.177 | 1.80 0.071 | 3.00 0.118 | - |
| (17) | 2744040447 | 18 | 29 | 56 | 60 | 1.60 | 1.80 0.071 | 4.80 0.189 | 0.80 0.032 | 3.00 0.118 | 1.27 0.050 |
| (18) | 2744040446 | 18 | 29 | 56 | 60 | 1.60 | 1.80 0.071 | 4.80 0.189 | 0.80 0.032 | 3.00 0.118 | 1.27 0.050 |
| (19) | 2744555567 | 150 | 250 | 375 | 385 | 3.80 | 2.00 0.079 | 7.00 0.276 | 2.00 0.079 | 5.00 0.197 | - |

Fair-Rite Products Corp. PO Box 288, One Commercial Row, Wallkill, NY 12589-0288

Phone: (888) FAIR RITE / (845) 895-2055 • Fax: (888) FERRITE / (845) 895-2629 • Web: www.fair-rite.com
 (888) 324-7748 (888) 337-7483 E -mail: ferrites@fair-rite.com

SM Beads (Differential-Mode)



Quick Link: www.fair-rite.com/sbd

Table Continued ...

| Row # | Part Number | Impedance (Ω) | | | | Max Rdc (m Ω) | Land Patterns | | | | |
|-------|-------------|------------------------|---------------------|----------------------|---------|-----------------------|---------------|---------------|---------------|---------------|---|
| | | 10 MHz | 25 MHz ⁺ | 100 MHz ⁺ | 250 MHz | | V | W (ref) | X | Y | Z |
| (20) | 2744555566 | 150 | 250 | 375 | 385 | 3.80 | 2.00 0.079 | 7.00 0.276 | 2.00 0.079 | 5.00 0.197 | - |
| (21) | 2744555577 | 255 | 425 | 600 | 575 | 6.20 | 2.00 0.079 | 7.00 0.276 | 2.00 0.079 | 5.00 0.197 | - |
| (22) | 2744555576 | 255 | 425 | 600 | 575 | 6.20 | 2.00 0.079 | 7.00 0.276 | 2.00 0.079 | 5.00 0.197 | - |

Higher Frequencies 250-1000 MHz (52 & 61 materials)

| Row # | Part Number | Fig. | A | B | C | D | Wt. (g) | Reel Information | | |
|-------|-------------|------|--------------------------|--------------------------|------------------------|--------------------------|---------|------------------|----------|----------------|
| | | | | | | | | Tape Width mm | Pitch mm | Parts 13" Reel |
| (23) | 2761019447 | 1 | 2.85 \pm 0.20 0.112 | 3.05 \pm 0.10 0.120 | 5.10 -0.85 0.184 | 1.50 \pm 0.50 0.059 | 0.15 | 12 | 8 | 2800 |
| (24) | 2761019446 | 1 | 2.85 \pm 0.20 0.112 | 3.05 \pm 0.10 0.120 | 5.10 -0.85 0.184 | 1.50 \pm 0.50 0.059 | 0.15 | - | - | - |
| (25) | 2761021447 | 1 | 2.85 \pm 0.20 0.112 | 3.05 \pm 0.10 0.120 | 9.60 -0.95 0.359 | 1.50 \pm 0.50 0.059 | 0.30 | 16 | 8 | 2800 |
| (26) | 2761021446 | 1 | 2.85 \pm 0.20 0.112 | 3.05 \pm 0.10 0.120 | 9.60 -0.95 0.359 | 1.50 \pm 0.50 0.059 | 0.30 | - | - | - |
| (27) | 2752555567 | 4 | 5.00 Max 0.197 Max | 5.00 \pm 0.25 0.197 | 11.00 Max 0.433 Max | 2.50 \pm 0.50 0.098 | 0.96 | 24 | 12 | 1500 |
| (28) | 2752555566 | 4 | 5.00 Max 0.197 Max | 5.00 \pm 0.25 0.197 | 11.00 Max 0.433 Max | 2.50 \pm 0.50 0.098 | 0.96 | - | - | - |
| (29) | 2752555577 | 3 | 5.00 Max 0.197 Max | 5.00 \pm 0.25 0.197 | 11.00 Max 0.433 Max | 2.50 \pm 0.50 0.098 | 0.96 | 24 | 12 | 1500 |
| (30) | 2752555576 | 3 | 5.00 Max 0.197 Max | 5.00 \pm 0.25 0.197 | 11.00 Max 0.433 Max | 2.50 \pm 0.50 0.098 | 0.96 | - | - | - |

Table Continued ...

| Row # | Part Number | Impedance (Ω) | | | | Max Rdc (m Ω) | Land Patterns | | | | |
|-------|-------------|------------------------|----------------------|----------------------|----------|-----------------------|---------------|---------------|---------------|---------------|---|
| | | 100 MHz | 250 MHz ⁺ | 500 MHz ⁺ | 1000 MHz | | V | W (ref) | X | Y | Z |
| (23) | 2761019447 | 36 | 50 | 55 | 59 | 0.80 | 1.00 0.040 | 4.00 0.157 | 1.80 0.071 | 3.00 0.118 | - |
| (24) | 2761019446 | 36 | 50 | 55 | 59 | 0.80 | 1.00 0.040 | 4.00 0.157 | 1.80 0.071 | 3.00 0.118 | - |
| (25) | 2761021447 | 69 | 94 | 106 | 118 | 1.20 | 4.50 0.177 | 7.50 0.295 | 1.80 0.071 | 3.00 0.118 | - |
| (26) | 2761021446 | 69 | 94 | 106 | 118 | 1.20 | 4.50 0.177 | 7.50 0.295 | 1.80 0.071 | 3.00 0.118 | - |
| (27) | 2752555567 | 400 | 490 | 425 | 250 | 3.80 | 2.00 0.079 | 7.00 0.276 | 2.00 0.079 | 5.00 0.197 | - |
| (28) | 2752555566 | 400 | 490 | 425 | 250 | 3.80 | 2.00 0.079 | 7.00 0.276 | 2.00 0.079 | 5.00 0.197 | - |
| (29) | 2752555577 | 700 | 770 | 440 | 250 | 6.20 | 2.00 0.079 | 7.00 0.276 | 2.00 0.079 | 5.00 0.197 | - |
| (30) | 2752555576 | 700 | 770 | 440 | 250 | 6.20 | 2.00 0.079 | 7.00 0.276 | 2.00 0.079 | 5.00 0.197 | - |

Fair-Rite Products Corp. PO Box 288, One Commercial Row, Wallkill, NY 12589-0288

SM Beads (Common-Mode)



Quick Link: www.fair-rite.com/sbc

Surface mount common-mode beads are available from Fair-Rite in several materials and sizes. The common-mode bead provides a common magnetic path for the flux generated by the current to the load and the return current from the load. The current compensation results in zero magnetic flux in the bead.

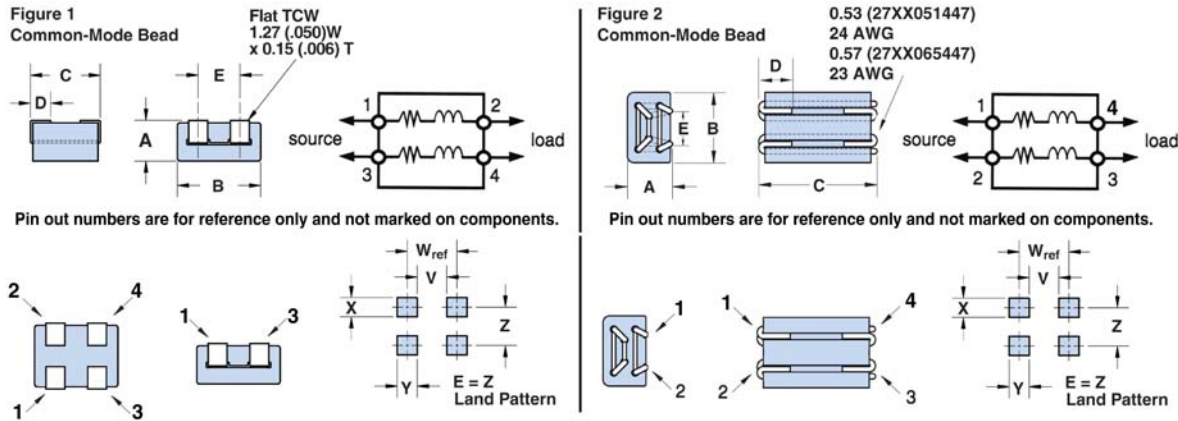

- SM Beads on 12 mm tape width are supplied taped and reeled per EIA 481-1 and IEC 60286-3 standards. SM Beads on 16 and 24 mm tape widths are supplied taped and reeled per EIA 481-2 and IEC 60286-3 standards. Taped and reeled parts are supplied on a 13" reel.
- SM Beads can also be supplied not taped and reeled and then are bulk packed. This packing method will change the last digit of the part number to a "6".
- Wires are oxygen free high conductivity copper with 100% matte tin plating over a nickel undercoating.
- SM Beads meet the solderability specifications when tested in accordance with MIL-STD-202, method 208. After dipping the mounting site of the bead, the solder surface shall be at least 95% covered with a smooth solder coating. The edges of the copper strip are not specified as solderable surfaces.
- After preheating the beads to within 100 °C of the soldering temperature, the parts meet the resistance to soldering requirements of EIA-186-10E, temperature 260±5 °C and time 10±1 seconds.
- Suggested land patterns are in accordance with the latest revision of IPC-7351.
- SM Beads are controlled for impedance limits only. Minimum impedance values are specified for the + marked frequencies. The minimum impedance is typically the listed value less 20%. SM Beads in 44 materials are measured for impedance on the 4193 Vector Impedance Analyzer. The 52 SM Beads are tested for impedance on the 4291A RF Impedance Analyzer.
- Recommended storage and operation temperature is -55 °C to 125 °C.
- The maximum current rating for these SM Beads is 5 amps.
- Performance curves for these suppression components are our web site.
- For any SM Bead requirement not listed, please contact our customer service group for availability and pricing.
- Our "Surface Mount Bead Kit" (part number 0199000025) is available for prototype evaluation.
- Explanation of Part Numbers: Digits 1&2 = product class, 3&4 = material grade, last digit 6 = bulk packed, 7 = taped and reeled.

Fair-Rite Products Corp. PO Box 288, One Commercial Row, Wallkill, NY 12589-0288

Phone: (888) FAIR RITE / (845) 895-2055 • Fax: (888) FERRITE / (845) 895-2629 • Web: www.fair-rite.com
 (888) 324-7748 (888) 337-7483 E -mail: ferrites@fair-rite.com

SM Beads (Common-Mode)



Quick Link: www.fair-rite.com/sbc

Legend

Dimensions (Top numbers are in millimeters, bottom numbers are in nominal inches.)

* Test frequency

Broadband Frequencies 10-300 MHz (44 material)

| Row # | Part Number | Fig. | A | B | C | D | E | Wt. (g) | Reel Information | | |
|-------|-------------|------|-----------------------|-----------------------|------------------------|---------------------|---------------------|---------|------------------|----------|----------------|
| | | | | | | | | | Tape Width mm | Pitch mm | Parts 13" Reel |
| (1) | 2744041447 | 1 | 2.85 ±0.20 0.112 | 5.60 ±0.20 0.220 | 5.00 -0.60 0.185 | 1.35 ±0.50 0.053 | 2.54 ±0.25 0.100 | 0.30 | 12 | 8 | 2400 |
| (2) | 2744041446 | 1 | 2.85 ±0.20 0.112 | 5.60 ±0.20 0.220 | 5.00 -0.60 0.185 | 1.35 ±0.50 0.053 | 2.54 ±0.25 0.100 | 0.30 | - | - | - |
| (3) | 2744045447 | 1 | 2.85 ±0.20 0.112 | 5.60 ±0.20 0.220 | 8.90 -0.80 0.335 | 1.35 ±0.50 0.053 | 2.54 ±0.25 0.100 | 0.53 | 16 | 8 | 2400 |
| (4) | 2744045446 | 1 | 2.85 ±0.20 0.112 | 5.60 ±0.20 0.220 | 8.90 -0.80 0.335 | 1.35 ±0.50 0.053 | 2.54 ±0.25 0.100 | 0.53 | - | - | - |
| (5) | 2744051447 | 2 | 4.50 Max 0.177 Max | 6.65 Max 0.262 Max | 12.00 Max 0.472 Max | 2.50 ±0.50 0.098 | 3.00 ±0.10 0.118 | 1.00 | 24 | 12 | 1000 |
| (6) | 2744051446 | 2 | 4.50 Max 0.177 Max | 6.65 Max 0.262 Max | 12.00 Max 0.472 Max | 2.50 ±0.50 0.098 | 3.00 ±0.10 0.118 | 1.00 | - | - | - |
| (7) | 2744065447 | 2 | 5.30 Max 0.209 Max | 7.00 Max 0.275 Max | 14.80 Max 0.582 Max | 2.50 ±0.50 0.098 | 3.00 ±0.10 0.118 | 1.80 | 24 | 12 | 1000 |
| (8) | 2744065446 | 2 | 5.30 Max 0.209 Max | 7.00 Max 0.275 Max | 14.80 Max 0.582 Max | 2.50 ±0.50 0.098 | 3.00 ±0.10 0.118 | 1.80 | - | - | - |

Table Continued ...

| Row # | Part Number | Impedance (Ω) | | | | | Max Rdc (mΩ) | Land Patterns | | | | |
|-------|-------------|---------------|---------------------|----------------------|---------|---------|--------------|---------------|----------------|---------------|---------------|---------------|
| | | 10 MHz | 25 MHz ⁺ | 100 MHz ⁺ | 250 MHz | 300 MHz | | V | W (ref) | X | Y | Z |
| (1) | 2744041447 | 12 | 20 | 33 | 41 | - | 1.10 | 1.00 0.040 | 4.00 0.158 | 1.80 0.071 | 3.00 0.118 | 2.54 0.100 |
| (2) | 2744041446 | 12 | 20 | 33 | 41 | - | 1.10 | 1.00 0.040 | 4.00 0.158 | 1.80 0.071 | 3.00 0.118 | 2.54 0.100 |
| (3) | 2744045447 | 23 | 38 | 60 | 78 | - | 1.40 | 4.00 0.158 | 7.00 0.276 | 1.80 0.071 | 3.00 0.118 | 2.54 0.100 |
| (4) | 2744045446 | 23 | 38 | 60 | 78 | - | 1.40 | 4.00 0.158 | 7.00 0.276 | 1.80 0.071 | 3.00 0.118 | 2.54 0.100 |
| (5) | 2744051447 | 60 | 100 | 230 | - | 275 | 4.00 | 4.00 0.158 | 9.00 0.354 | 1.00 0.040 | 5.00 0.197 | 3.00 0.118 |
| (6) | 2744051446 | 60 | 100 | 230 | - | 275 | 4.00 | 4.00 0.158 | 9.00 0.354 | 1.00 0.040 | 5.00 0.197 | 3.00 0.118 |
| (7) | 2744065447 | 95 | 145 | 255 | - | 315 | 4.10 | 6.80 0.268 | 11.80 0.465 | 1.10 0.043 | 5.00 0.197 | 3.00 0.118 |
| (8) | 2744065446 | 95 | 145 | 255 | - | 315 | 4.10 | 6.80 0.268 | 11.80 0.465 | 1.10 0.043 | 5.00 0.197 | 3.00 0.118 |

Fair-Rite Products Corp. PO Box 288, One Commercial Row, Wallkill, NY 12589-0288

SM Beads (Common-Mode)



Quick Link: www.fair-rite.com/sbc

Higher Frequencies 250-1000 MHz (52 material)

| Row # | Part Number | Fig. | A | B | C | D | E | Wt. (g) | Reel Information | | |
|-------|-------------|------|-----------------------|-----------------------|------------------------|---------------------|---------------------|---------|------------------|----------|----------------|
| | | | | | | | | | Tape Width mm | Pitch mm | Parts 13" Reel |
| (9) | 2752041447 | 1 | 2.85 ±0.20 0.112 | 5.60 ±0.20 0.220 | 5.00 -0.60 0.185 | 1.35 ±0.50 0.053 | 2.54 ±0.25 0.100 | 0.30 | 12 | 8 | 2400 |
| (10) | 2752041446 | 1 | 2.85 ±0.20 0.112 | 5.60 ±0.20 0.220 | 5.00 -0.60 0.185 | 1.35 ±0.50 0.053 | 2.54 ±0.25 0.100 | 0.30 | - | - | - |
| (11) | 2752045447 | 1 | 2.85 ±0.20 0.112 | 5.60 ±0.20 0.220 | 8.90 -0.80 0.335 | 1.35 ±0.50 0.053 | 2.54 ±0.25 0.100 | 0.53 | 16 | 8 | 2400 |
| (12) | 2752045446 | 1 | 2.85 ±0.20 0.112 | 5.60 ±0.20 0.220 | 8.90 -0.80 0.335 | 1.35 ±0.50 0.053 | 2.54 ±0.25 0.100 | 0.53 | - | - | - |
| (13) | 2752051447 | 2 | 4.50 Max 0.177 Max | 6.65 Max 0.262 Max | 12.00 Max 0.472 Max | 2.50 ±0.50 0.098 | 3.00 ±0.10 0.118 | 1.00 | 24 | 12 | 1000 |
| (14) | 2752051446 | 2 | 4.50 Max 0.177 Max | 6.65 Max 0.262 Max | 12.00 Max 0.472 Max | 2.50 ±0.50 0.098 | 3.00 ±0.10 0.118 | 1.00 | - | - | - |
| (15) | 2752065447 | 2 | 5.30 Max 0.209 Max | 7.00 Max 0.275 Max | 14.80 Max 0.582 Max | 2.50 ±0.50 0.098 | 3.00 ±0.10 0.118 | 1.80 | 24 | 12 | 1000 |
| (16) | 2752065446 | 2 | 5.30 Max 0.209 Max | 7.00 Max 0.275 Max | 14.80 Max 0.582 Max | 2.50 ±0.50 0.098 | 3.00 ±0.10 0.118 | 1.80 | - | - | - |

Table Continued ...

| Row # | Part Number | Impedance (Ω) | | | | Max Rdc (mΩ) | Land Patterns | | | | |
|-------|-------------|---------------|----------------------|----------------------|----------|--------------|---------------|----------------|---------------|---------------|---------------|
| | | 100 MHz | 250 MHz ⁺ | 500 MHz ⁺ | 1000 MHz | | V | W (ref) | X | Y | Z |
| (9) | 2752041447 | 30 | 50 | 60 | 70 | 1.10 | 1.00 0.040 | 4.00 0.158 | 1.80 0.071 | 3.00 0.118 | 2.54 0.100 |
| (10) | 2752041446 | 30 | 50 | 60 | 70 | 1.10 | 1.00 0.040 | 4.00 0.158 | 1.80 0.071 | 3.00 0.118 | 2.54 0.100 |
| (11) | 2752045447 | 58 | 90 | 115 | 130 | 1.40 | 4.00 0.158 | 7.00 0.276 | 1.80 0.071 | 3.00 0.118 | 2.54 0.100 |
| (12) | 2752045446 | 58 | 90 | 115 | 130 | 1.40 | 4.00 0.158 | 7.00 0.276 | 1.80 0.071 | 3.00 0.118 | 2.54 0.100 |
| (13) | 2752051447 | 200 | 330 | 340 | 350 | 4.00 | 4.00 0.158 | 9.00 0.354 | 1.00 0.040 | 5.00 0.197 | 3.00 0.118 |
| (14) | 2752051446 | 200 | 330 | 340 | 350 | 4.00 | 4.00 0.158 | 9.00 0.354 | 1.00 0.040 | 5.00 0.197 | 3.00 0.118 |
| (15) | 2752065447 | 230 | 380 | 450 | 380 | 4.10 | 6.80 0.268 | 11.80 0.465 | 1.10 0.043 | 5.00 0.197 | 3.00 0.118 |
| (16) | 2752065446 | 230 | 380 | 450 | 380 | 4.10 | 6.80 0.268 | 11.80 0.465 | 1.10 0.043 | 5.00 0.197 | 3.00 0.118 |

Fair-Rite Products Corp. PO Box 288, One Commercial Row, Wallkill, NY 12589-0288

Phone: (888) FAIR RITE / (845) 895-2055 • Fax: (888) FERRITE / (845) 895-2629 • Web: www.fair-rite.com
 (888) 324-7748 (888) 337-7483 E -mail: ferrites@fair-rite.com

Quick Link: www.fair-rite.com/cb

Fair-Rite offers a broad selection of cost effective multi-layer chip beads to suppress conducted EMI signals. Chip beads can be used in an array of devices such as cellular phones, computers, laptops, pagers, etc. The small package sizes accommodate automated placements and allow for a dense packaging of circuit boards. Chip beads are 100% tested for impedance and dc resistance. They are available in standard, high and GHz signal speeds. The multi-layer chip beads are organized by increasing package size and current carrying capacity.

- All multi-layer chip beads are supplied taped and reeled, if required bulk packed chip beads can be provided.
- The impedance values listed are typical values. The nominal impedance with a +/- 25% tolerance is specified for the + marked 100 MHz. Chip beads are measured for impedance on the HP 4291A and fixture HP 16192A.
- Chip beads have plated contacts, 100% matte tin over a nickel undercoating. They can accommodate both reflow and wave soldering technologies.
- The suggested land patterns are in accordance to the latest revision of IPC-7351.
- Recommended storage and operating temperature range is -55 °C to 125 °C.
- Performance curves for these suppression components are our web site.
- Our "Chip Bead Kit" (part number 0199000018) is available for prototype evaluation.

Part Number System: Example 2512063017Y1

| 25 | 1206 | 301 | 7 | Y | 1 |
|-----------------------|--------------------------|-----------------------|---|---|---|
| Chip Bead Code | Package Size Code | Impedance Code | Packaging Code | Material Code | Current Code |
| | | 300Ω | 6= Bulk Packed 7= Taped and Reeled 7" Reel 8= Taped and Reeled 13" Reel | Y = Standard Signal Speed Z = High Signal Speed H = GHz Speed | 0 < 1.0A 1 ≥ 1.0A < 2.0A 3 ≥ 3.0A < 4.0A ETC |

Chip Beads



Quick Link: www.fair-rite.com/cb

Legend

Dimensions (Top numbers are in millimeters, bottom numbers are in nominal inches.)

| Pkg. Size | A | B | C | D | Wt. (g) | Land Patterns | | | | Reel Information | | | |
|----------------|-------------------|-------------------|-------------------|--------------------|---------|---------------|---------------|---------------|---------------|------------------|----------|---------------|----------------|
| | | | | | | V | W (ref) | X | Y | Tape Width mm | Pitch mm | Parts 7" Reel | Parts 13" Reel |
| 0402 (1005) | 0.5±0.05 0.020 | 0.5±0.05 0.020 | 1.0±0.05 0.040 | 0.25±0.15 0.010 | 0.002 | 0.40 0.016 | 1.30 0.051 | 0.70 0.028 | 0.90 0.035 | 8 | 4 | 10000 | — |
| 0603 (1608) | 0.8±0.15 0.031 | 0.8±0.15 0.031 | 1.6±0.15 0.063 | 0.4±0.2 0.016 | 0.006 | 0.60 0.024 | 1.70 0.067 | 1.00 0.039 | 1.10 0.043 | 8 | 4 | 4000 | 10000 |
| 0805 (2012) | 0.9±0.2 0.035 | 1.25±0.2 0.049 | 2.0±0.2 0.079 | 0.5±0.3 0.020 | 0.01 | 0.60 0.024 | 1.90 0.075 | 1.50 0.059 | 1.30 0.051 | 8 | 4 | 4000 | 10000 |
| 1206 (3216) | 1.1±0.2 0.043 | 1.6±0.2 0.063 | 3.2±0.2 0.126 | 0.7±0.3 0.028 | 0.03 | 1.20 0.047 | 2.80 0.110 | 1.80 0.071 | 1.60 0.063 | 8 | 4 | 3000 | 10000 |
| 1806 (4516) | 1.6±0.2 0.063 | 1.6±0.2 0.063 | 4.5±0.2 0.177 | 0.7±0.3 0.028 | 0.06 | 2.00 0.079 | 3.90 0.154 | 1.80 0.071 | 1.90 0.075 | 12 | 8 | 2000 | 10000 |
| 1812 (4532) | 1.5±0.2 0.059 | 3.2±0.2 0.126 | 4.5±0.2 0.177 | 0.7±0.3 0.028 | 0.09 | 2.00 0.079 | 3.90 0.154 | 3.40 0.134 | 1.90 0.075 | 12 | 8 | 1000 | 5000 |

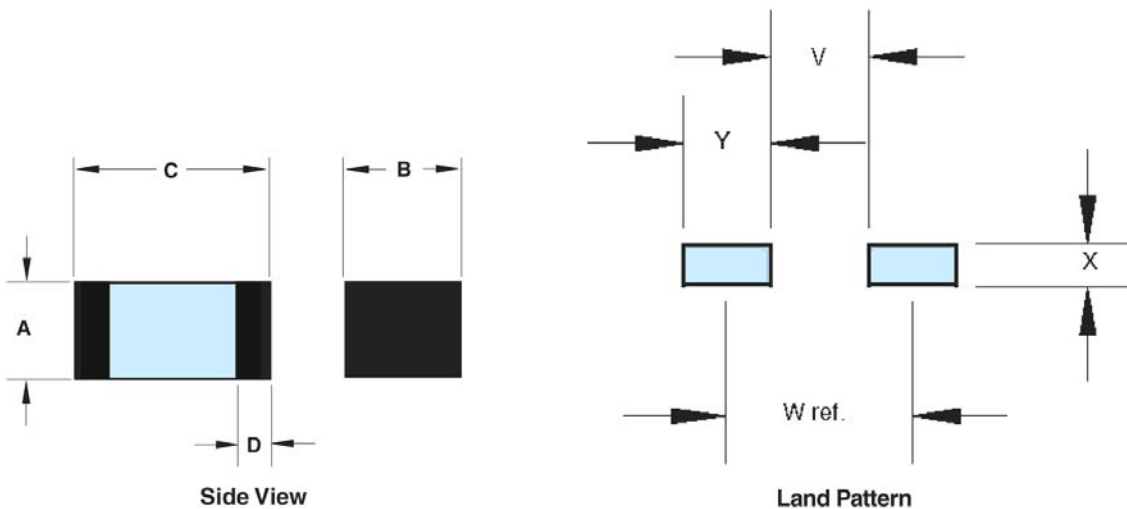

Fair-Rite Products Corp. PO Box 288, One Commercial Row, Wallkill, NY 12589-0288

Phone: (888) FAIR RITE / (845) 895-2055 • Fax: (888) FERRITE / (845) 895-2629 • Web: www.fair-rite.com
 (888) 324-7748 (888) 337-7483 E -mail: ferrites@fair-rite.com

Legend

Chip Beads are listed in ascending order by current, package size, impedance and signal speed. * Test frequency

Low Current

| Part Number | Pkg. Size | Impedance (Ω) | | | | | Signal Speed | Max DCR (Ω) | Max Current (mA) |
|--------------|-------------|------------------------|----------------------|---------|----------|-----------------------|--------------|----------------------|------------------|
| | | 50 MHz | 100 MHz ⁺ | 500 MHz | 1000 MHz | 1000 MHz ⁺ | | | |
| 2504021007Y0 | 0402 (1005) | 8 | 10 \pm 25% | 13 | 14 | - | Standard | 0.050 | 500 |
| 2504026007Y0 | 0402 (1005) | 48 | 60 \pm 25% | 79 | 79 | - | Standard | 0.400 | 200 |
| 2504021217Y0 | 0402 (1005) | 88 | 120 \pm 25% | 170 | 157 | - | Standard | 0.500 | 200 |
| 2504023017Y0 | 0402 (1005) | 234 | 300 \pm 25% | 370 | 264 | - | Standard | 0.750 | 100 |
| 2504026017Y0 | 0402 (1005) | 421 | 600 \pm 25% | 652 | 362 | - | Standard | 1.100 | 50 |
| 2506033007Y0 | 0603 (1608) | 23 | 30 \pm 25% | 46 | 48 | - | Standard | 0.100 | 400 |
| 2506036007Y0 | 0603 (1608) | 45 | 60 \pm 25% | 94 | 82 | - | Standard | 0.150 | 400 |
| 2506038007Y0 | 0603 (1608) | 59 | 80 \pm 25% | 121 | 102 | - | Standard | 0.150 | 400 |
| 2506031017Y0 | 0603 (1608) | 77 | 100 \pm 25% | 144 | 131 | - | Standard | 0.150 | 400 |
| 2506031217Y0 | 0603 (1608) | 90 | 120 \pm 25% | 179 | 142 | - | Standard | 0.150 | 400 |
| 2506031517Y0 | 0603 (1608) | 109 | 150 \pm 25% | 224 | 179 | - | Standard | 0.150 | 400 |
| 2506033017Y0 | 0603 (1608) | 213 | 300 \pm 25% | 326 | 205 | - | Standard | 0.300 | 400 |
| 2506036017Y0 | 0603 (1608) | 426 | 600 \pm 25% | 405 | 226 | - | Standard | 0.350 | 400 |
| 2506031027Y0 | 0603 (1608) | 653 | 1000 \pm 25% | 241 | 110 | - | Standard | 0.550 | 300 |
| 2506036007Z0 | 0603 (1608) | 28 | 60 \pm 25% | 145 | 96 | - | High | 0.250 | 450 |
| 2506031217Z0 | 0603 (1608) | 60 | 120 \pm 25% | 278 | 192 | - | High | 0.300 | 450 |
| 2506033017Z0 | 0603 (1608) | 112 | 300 \pm 25% | 314 | 142 | - | High | 0.350 | 450 |
| 2506030707H0 | 0603 (1608) | 4 | 7 \pm 25% | 30 | 38 | - | GHz | 0.100 | 900 |
| 2506031007H0 | 0603 (1608) | 5 | 10 \pm 25% | 43 | 50 | - | GHz | 0.100 | 900 |
| 2506031217H0 | 0603 (1608) | 50 | 120 \pm 25% | 600 | - | 500 \pm 40% | GHz | 0.500 | 200 |
| 2506032217H0 | 0603 (1608) | 100 | 220 \pm 25% | 800 | - | 1100 \pm 40% | GHz | 0.800 | 100 |
| 2506033317H0 | 0603 (1608) | 150 | 330 \pm 25% | 1300 | - | 1300 \pm 40% | GHz | 1.200 | 50 |
| 2506031027H0 | 0603 (1608) | 500 | 1000 \pm 25% | 1800 | - | 1200 | GHz | 1.500 | 50 |
| 2508051107Y0 | 0805 (2012) | 8 | 11 \pm 25% | 16 | 16 | - | Standard | 0.100 | 300 |
| 2508053007Y0 | 0805 (2012) | 22 | 30 \pm 25% | 46 | 49 | - | Standard | 0.100 | 300 |
| 2508055007Y0 | 0805 (2012) | 36 | 50 \pm 25% | 73 | 76 | - | Standard | 0.150 | 300 |

Quick Link: www.fair-rite.com/cb

Low Current

| Part Number | Pkg. Size | Impedance (Ω) | | | | | Signal Speed | Max DCR (Ω) | Max Current (mA) |
|--------------|-------------|------------------------|----------------------|---------|----------|-----------------------|--------------|----------------------|------------------|
| | | 50 MHz | 100 MHz ⁺ | 500 MHz | 1000 MHz | 1000 MHz ⁺ | | | |
| 2508056007Y0 | 0805 (2012) | 45 | 60 \pm 25% | 88 | 89 | - | Standard | 0.150 | 300 |
| 2508059007Y0 | 0805 (2012) | 68 | 90 \pm 25% | 125 | 107 | - | Standard | 0.150 | 300 |
| 2508051017Y0 | 0805 (2012) | 75 | 100 \pm 25% | 134 | 120 | - | Standard | 0.200 | 300 |
| 2508051217Y0 | 0805 (2012) | 89 | 120 \pm 25% | 172 | 127 | - | Standard | 0.200 | 300 |
| 2508051817Y0 | 0805 (2012) | 134 | 180 \pm 25% | 198 | 111 | - | Standard | 0.200 | 300 |
| 2508053017Y0 | 0805 (2012) | 216 | 300 \pm 25% | 161 | 84 | - | Standard | 0.250 | 300 |
| 2508056017Y0 | 0805 (2012) | 428 | 600 \pm 25% | 284 | 141 | - | Standard | 0.350 | 300 |
| 2508051027Y0 | 0805 (2012) | 688 | 1000 \pm 25% | 300 | 148 | - | Standard | 0.450 | 300 |
| 2508051527Y0 | 0805 (2012) | 989 | 1500 \pm 25% | 235 | 118 | - | Standard | 0.700 | 300 |
| 2508056007Z0 | 0805 (2012) | 28 | 60 \pm 25% | 111 | 122 | - | High | 0.150 | 300 |
| 2508051217Z0 | 0805 (2012) | 45 | 120 \pm 25% | 253 | 191 | - | High | 0.200 | 300 |
| 2508053017Z0 | 0805 (2012) | 118 | 300 \pm 25% | 280 | 139 | - | High | 0.250 | 200 |
| 2508052027Z0 | 0805 (2012) | 440 | 2000 \pm 25% | 160 | 80 | - | High | 0.400 | 200 |
| 2512063007Y0 | 1206 (3216) | 21 | 30 \pm 25% | 49 | 52 | - | Standard | 0.100 | 800 |
| 2512065007Y0 | 1206 (3216) | 38 | 50 \pm 25% | 68 | 67 | - | Standard | 0.150 | 800 |
| 2512067007Y0 | 1206 (3216) | 53 | 70 \pm 25% | 101 | 102 | - | Standard | 0.150 | 500 |
| 2512069007Y0 | 1206 (3216) | 72 | 90 \pm 25% | 121 | 113 | - | Standard | 0.150 | 450 |
| 2512061017Y0 | 1206 (3216) | 72 | 100 \pm 25% | 127 | 86 | - | Standard | 0.200 | 450 |
| 2512061217Y0 | 1206 (3216) | 87 | 120 \pm 25% | 151 | 109 | - | Standard | 0.200 | 450 |
| 2512063017Y0 | 1206 (3216) | 203 | 300 \pm 25% | 233 | 118 | - | Standard | 0.200 | 350 |
| 2512066017Y0 | 1206 (3216) | 581 | 600 \pm 25% | 116 | 67 | - | Standard | 0.250 | 350 |
| 2512061027Y0 | 1206 (3216) | 784 | 1000 \pm 25% | 230 | 117 | - | Standard | 0.350 | 350 |
| 2512061527Y0 | 1206 (3216) | 1600 | 1500 \pm 25% | 120 | 25 | - | Standard | 0.400 | 350 |
| 2518061017Y0 | 1806 (4516) | 73 | 100 \pm 25% | 153 | 155 | - | Standard | 0.300 | 400 |
| 2518061517Y0 | 1806 (4516) | 110 | 150 \pm 25% | 205 | 167 | - | Standard | 0.500 | 200 |

Medium Current

| Part Number | Pkg. Size | Impedance (Ω) | | | | Signal Speed | Max DCR (Ω) | Max Current (mA) |
|--------------|-------------|------------------------|----------------------|---------|----------|--------------|----------------------|------------------|
| | | 50 MHz | 100 MHz [†] | 500 MHz | 1000 MHz | | | |
| 2506033007Y3 | 0603 (1608) | 23 | 30 \pm 25% | 40 | 41 | Standard | 0.040 | 3000 |
| 2506036007Y3 | 0603 (1608) | 48 | 60 \pm 25% | 84 | 81 | Standard | 0.040 | 3000 |
| 2506031217Y2 | 0603 (1608) | 90 | 120 \pm 25% | 170 | 152 | Standard | 0.050 | 2000 |
| 2508053007Y3 | 0805 (2012) | 23 | 30 \pm 25% | 41 | 41 | Standard | 0.030 | 3000 |
| 2508056007Y3 | 0805 (2012) | 49 | 60 \pm 25% | 84 | 84 | Standard | 0.040 | 3000 |
| 2508051217Y3 | 0805 (2012) | 91 | 120 \pm 25% | 165 | 135 | Standard | 0.050 | 3000 |
| 2508053017Y3 | 0805 (2012) | 239 | 300 \pm 25% | 218 | 117 | Standard | 0.050 | 3000 |
| 2508056017Y2 | 0805 (2012) | 449 | 600 \pm 25% | 293 | 159 | Standard | 0.100 | 2000 |
| 2508051027Y1 | 0805 (2012) | 764 | 1000 \pm 25% | 402 | 216 | Standard | 0.300 | 1000 |
| 2508052027Y1 | 0805 (2012) | 599 | 2000 \pm 25% | 350 | 189 | Standard | 0.300 | 1000 |
| 2512063007Y3 | 1206 (3216) | 24 | 30 \pm 25% | 40 | 38 | Standard | 0.030 | 3000 |
| 2512065007Y3 | 1206 (3216) | 39 | 50 \pm 25% | 69 | 70 | Standard | 0.030 | 3000 |
| 2512067007Y3 | 1206 (3216) | 53 | 70 \pm 25% | 102 | 103 | Standard | 0.040 | 3000 |
| 2512061517Y3 | 1206 (3216) | 120 | 150 \pm 25% | 173 | 130 | Standard | 0.050 | 3000 |
| 2512063017Y3 | 1206 (3216) | 212 | 300 \pm 25% | 150 | 88 | Standard | 0.060 | 3000 |
| 2512066017Y1 | 1206 (3216) | 460 | 600 \pm 25% | 260 | 120 | Standard | 0.150 | 1000 |
| 2512061027Y1 | 1206 (3216) | 925 | 1000 \pm 25% | 210 | 117 | Standard | 0.300 | 1000 |
| 2518066007Y3 | 1806 (4516) | 44 | 60 \pm 25% | 91 | 94 | Standard | 0.040 | 3000 |
| 2518068007Y3 | 1806 (4516) | 64 | 80 \pm 25% | 114 | 114 | Standard | 0.040 | 3000 |
| 2518127007Y3 | 1812 (4532) | 54 | 70 \pm 25% | 96 | 96 | Standard | 0.040 | 3000 |
| 2518121217Y3 | 1812 (4532) | 92 | 120 \pm 25% | 150 | 106 | Standard | 0.040 | 3000 |

Quick Link: www.fair-rite.com/cb

High Current

| Part Number | Pkg. Size | Impedance (Ω) | | | | Signal Speed | Max DCR (Ω) | Max Current (mA) |
|--------------|-------------|------------------------|----------------------|---------|----------|--------------|----------------------|------------------|
| | | 50 MHz | 100 MHz [†] | 500 MHz | 1000 MHz | | | |
| 2508056007Y6 | 0805 (2012) | 47 | 60 \pm 25% | 88 | 68 | Standard | 0.020 | 6000 |
| 2508051217Y6 | 0805 (2012) | 94 | 120 \pm 25% | 158 | 132 | Standard | 0.025 | 6000 |
| 2512065007Y6 | 1206 (3216) | 39 | 50 \pm 25% | 68 | 56 | Standard | 0.008 | 6000 |
| 2512061217Y5 | 1206 (3216) | 96 | 120 \pm 25% | 137 | 91 | Standard | 0.025 | 5000 |
| 2518065007Y6 | 1806 (4516) | 36 | 50 \pm 25% | 63 | 61 | Standard | 0.010 | 6000 |
| 2518061017Y6 | 1806 (4516) | 75 | 100 \pm 25% | 139 | 132 | Standard | 0.020 | 6000 |
| 2518121217Y6 | 1812 (4532) | 92 | 120 \pm 25% | 149 | 105 | Standard | 0.020 | 6000 |

Quick Link: www.fair-rite.com/ca

Fair-Rite offers an effective cost and real estate reduction by our line of chip arrays. Four chip beads, packaged in a 1206 (3216) size, for suppression of conducted EMI where size is at a premium. Chip arrays are 100% tested for impedance and dc resistance.

- Chip arrays have plated contacts, 100% matte tin over a nickel undercoating.
- Chip arrays are supplied taped and reeled.
- Chip arrays are controlled for impedance. The impedance values listed are typical values. The nominal impedance with a +/- 25% tolerance is specified for the + marked 100 MHz frequency. Chip arrays are measured for impedance on the HP 4291A and fixture HP 16192A.
- The arrays can accommodate both reflow and wave soldering technologies.
- Suggested land patterns are in accordance to the IPC-7351.
- Recommended storage and operating temperature range is -55 °C to 125 °C.
- Performance curves for these suppression components are on our web site.
- “Chip Bead Kit” (part number 0199000018) contains the 600 ohm 4 line chip array.
- The maximum voltage between adjacent beads is 5V.

Part Number System: Example 2512066007Y0A4

| 25 | 1206 | 600 | 7 | Y | 0 | A4 |
|----------------------------|--------------|----------------|---|----------------------|--------------|---------------|
| Chip Suppression Component | Package Size | Impedance Code | Packaging Code | Material Code | Current Code | Array 4 Lines |
| | | 600 = 60 Ω | 6= Bulk Packed 7= Taped and Reeled 7" Reel 8= Taped and Reeled 13" Reel | Y = Std Signal Speed | 0 < 1A | |

Quick Link: www.fair-rite.com/ca

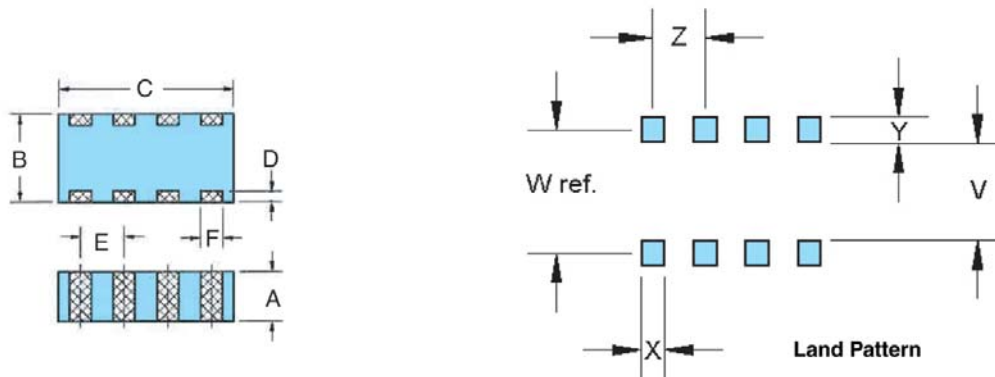

Legend

Dimensions (Top numbers are in millimeters, bottom numbers are in nominal inches.)

* Test frequency

| Pkg. Size | A | B | C | D | E | F | Wt. (g) | Land Patterns | | | | | Reel Information | | |
|----------------|------------------|------------------|------------------|------------------|------------------|-------------------|---------|---------------|--------------|--------------|--------------|--------------|------------------|----------|---------------|
| | | | | | | | | V | W (ref) | X | Y | Z | Tape Width mm | Pitch mm | Parts 7" Reel |
| 1206 (3216) | 0.8±0.2 0.032 | 1.6±0.2 0.063 | 3.2±0.2 0.126 | 0.3±0.2 0.011 | 0.8±0.1 0.032 | 0.45±0.2 0.018 | 0.03 | 0.7 0.028 | 1.3 0.051 | 0.5 0.020 | 0.6 0.024 | 0.8 0.032 | 8 | 4 | 3000 |

Standard Signal Speed

| Part Number | Pkg. Size | Impedance (Ω) | | | | Max DCR (Ω) | Max Current (mA) |
|----------------|----------------|---------------|----------------------|---------|----------|-------------|------------------|
| | | 50 MHz | 100 MHz ⁺ | 500 MHz | 1000 MHz | | |
| 2512066007Y0A4 | 1206 (3216) | 48 | 60 ±25% | 77 | 75 | 0.250 | 200 |
| 2512061217Y0A4 | 1206 (3216) | 95 | 120 ±25% | 150 | 118 | 0.300 | 150 |
| 2512063017Y0A4 | 1206 (3216) | 225 | 300 ±25% | 280 | 160 | 0.300 | 150 |
| 2512066017Y0A4 | 1206 (3216) | 460 | 600 ±25% | 400 | 205 | 0.500 | 100 |
| 2512061027Y0A4 | 1206 (3216) | 770 | 1000 ±25% | 400 | 200 | 0.700 | 50 |

Engineering Kits



Quick Link: www.fair-rite.com/kit



Fair-Rite Products Corp. PO Box 288, One Commercial Row, Wallkill, NY 12589-0288

Quick Link: www.fair-rite.com/kit

Expanded Cable & Suppressor Kit

| Part Number | Kit Description |
|-------------|---|
| 0199000005 | Contains a broad sampling of suppression cores to reduce conducted EMI over wires and cables. |

| Round Cable Cores 31 Matl (1-300 MHz) | Qty |
|---|-----|
| 2631102002 | 2 |
| 2631540002 | 2 |
| 2631665702 | 2 |
| | |
| Round Cable Cores 43 Matl (25-300 MHz) | Qty |
| 2643626502 | 2 |
| 2643801002 | 2 |
| 2643802702 | 2 |
| | |
| Round Cable Cores 46 Matl (25-300 MHz) | Qty |
| 2646102002 | 2 |
| 2646540002 | 2 |
| 2646625002 | 2 |
| 2646625102 | 2 |
| 2646665702 | 2 |
| 2646665802 | 2 |
| 2646803802 | 2 |
| 2646804502 | 2 |

| Round Cable Cores 61 Matl (200-1000 MHz) | Qty |
|---|-----|
| 2661102002 | 2 |
| 2661540002 | 2 |
| 2661665702 | 2 |
| | |
| Clips | Qty |
| 0199001401 | 8 |
| | |
| Flat Cable Cores 31 Matl (1-300 MHz) | Qty |
| 2631163851 | 2 |
| | |
| Flat Cable Cores 43 Matl (25-300 MHz) | Qty |
| 2643163851 | 2 |
| 2643163951 | 2 |
| 2643164051 | 2 |
| 2643166651 | 2 |
| 2643166851 | 4 |

| Round Cable Snap-Its 43 Matl (25-300 MHz) | Qty |
|--|-----|
| 0443178181 | 2 |
| | |
| Round Cable Snap-Its 46 Matl (25-300 MHz) | Qty |
| 0446164151 | 2 |
| 0446164251 | 2 |
| 0446167251 | 2 |
| | |
| Round Cable Snap-Its 61 Matl (200-1000 MHz) | Qty |
| 0461164281 | 2 |
| 0461167281 | 2 |
| | |
| Flat Cable Snap-Its 43 Matl (25-300 MHz) | Qty |
| 0443163951 | 1 |
| 0443164051 | 1 |
| 0443166651 | 1 |

Chip Bead Kit

| Part Number | Kit Description |
|-------------|--|
| 0199000018 | Contains a number of different EIA size chip components with a range of impedance values and signal speeds. Also included is one of our chip arrays. |

| Chip Bead 0402 (1005) | Z (Ω) 100 MHz | Qty |
|---------------------------|------------------|-----|
| 2504026017Y0 | 600 | 80 |
| | | |
| Chip Beads 0603 (1608) | Z (Ω) 100 MHz | Qty |
| 2506031017Y0 | 100 | 75 |
| 2506031217Y0 | 120 | 75 |
| 2506033017Y0 | 300 | 75 |
| 2506036017Y0 | 600 | 75 |
| 2506031007H0 | 10 | 75 |
| 2506031217Y2 | 120 | 75 |

| Chip Beads 0805 (2012) | Z (Ω) 100 MHz | Qty |
|---------------------------|------------------|-----|
| 2508051217Y0 | 120 | 60 |
| 2508053017Z0 | 300 | 60 |
| 2508053017Y3 | 300 | 60 |
| 2508056017Y2 | 600 | 60 |
| 2508052027Y1 | 2000 | 60 |
| 2508056007Y6 | 60 | 60 |

| Chip Beads 1206 (3216) | Z (Ω) 100 MHz | Qty |
|---------------------------|------------------|-----|
| 2512069007Y0 | 90 | 50 |
| 2512066017Y0 | 600 | 50 |
| 2512061517Y3 | 150 | 50 |
| 2512061027Y1 | 1000 | 50 |
| 2512061217Y5 | 120 | 50 |
| | | |
| Chip Bead 1806 (4516) | Z (Ω) 100 MHz | Qty |
| 2518065007Y6 | 50 | 40 |
| | | |
| Chip Array 1206 (3216) | Z (Ω) 100 MHz | Qty |
| 2512066017Y0A4 | 600 (4) | 40 |

Fair-Rite Products Corp. PO Box 288, One Commercial Row, Wallkill, NY 12589-0288

Phone: (888) FAIR RITE / (845) 895-2055 • Fax: (888) FERRITE / (845) 895-2629 • Web: www.fair-rite.com
 (888) 324-7748 (888) 337-7483 E -mail: ferrites@fair-rite.com

Quick Link: www.fair-rite.com/kit

Shield Bead Kit

| Part Number | Kit Description |
|-------------|--|
| 0199000019 | Contains 28 different beads in three suppression materials, 73, 43 and 61. |

| 73 Matl (< 50 MHz) | Qty |
|--------------------|-----|
| 2673000101 | 15 |
| 2673000301 | 10 |
| 2673000501 | 25 |
| 2673000801 | 5 |
| 2673002402 | 5 |
| 2673004801 | 25 |
| 2673021801 | 5 |
| 2673030101 | 25 |
| 2673901301 | 25 |

| 43 Matl (25-300 MHz) | Qty |
|----------------------|-----|
| 2643000101 | 15 |
| 2643000201 | 25 |
| 2643000301 | 10 |
| 2643000501 | 25 |
| 2643000801 | 5 |
| 2643001301 | 10 |
| 2643001501 | 10 |
| 2643002402 | 5 |
| 2643004801 | 25 |
| 2643021801 | 10 |
| 2643022401 | 10 |
| 2643250402 | 5 |
| 2643300101 | 5 |
| 2643375102 | 5 |

| 61 Matl (250-1000 MHz) | Qty |
|------------------------|-----|
| 2661000101 | 15 |
| 2661000301 | 10 |
| 2661000801 | 5 |
| 2661021801 | 10 |
| 2661375102 | 5 |

Antenna/RFID Kit

| Part Number | Kit Description |
|-------------|---|
| 0199000024 | Contains a range of rods in three low losses, high Q materials, 78, 61 and 67 to cover frequencies from 10 kHz to 50 MHz. |

| 78 Matl (< 200 kHz) | Qty |
|---------------------|-----|
| 3078990821 | 50 |
| 3078990831 | 25 |
| 3078990841 | 25 |
| 3078990851 | 20 |
| 3078990861 | 15 |
| 3078990871 | 15 |
| 3078990881 | 10 |
| 3078990891 | 8 |
| 3078990901 | 5 |
| 3078990911 | 3 |

| 61 Matl (200 kHz-5 MHz) | Qty |
|-------------------------|-----|
| 3061990821 | 50 |
| 3061990831 | 25 |
| 3061990841 | 25 |
| 3061990851 | 20 |
| 3061990861 | 15 |
| 3061990871 | 15 |
| 3061990881 | 10 |
| 3061990891 | 8 |

| 67 Matl (> 5 MHz) | Qty |
|-------------------|-----|
| 3067990821 | 50 |
| 3067990831 | 25 |
| 3067990841 | 25 |
| 3067990851 | 20 |
| 3067990861 | 15 |
| 3067990871 | 15 |
| 3067990881 | 10 |

Quick Link: www.fair-rite.com/kit

Surface Mount Bead Kit

| Part Number | Kit Description |
|-------------|---|
| 0199000025 | Contains an assortment of surface mount beads for differential and common-mode applications in 73 material for < 50 MHz, 43/44 material for 25-300 MHz and 52/61 material for 250-1000 MHz frequencies. |

| 73 Matl (< 50 MHz) Differential Mode | Qty |
|--|-----|
| 2773019447 | 12 |
| 2773021447 | 12 |
| | |
| 43/44 Matl (25-300 MHz) Differential Mode | Qty |
| 2743019447 | 12 |
| 2743021447 | 12 |
| 2743037447 | 12 |
| 2744044447 | 12 |
| 2744555567 | 5 |
| 2744555577 | 6 |

| 44 Matl (25-300 MHz) Common-Mode | Qty |
|--|-----|
| 2744041447 | 12 |
| 2744045447 | 12 |
| 2744051447 | 5 |
| 2744065447 | 5 |
| | |
| 52/61 Matl (250-1000 MHz) Differential Mode | Qty |
| 2761019447 | 12 |
| 2761021447 | 12 |
| 2752555567 | 5 |
| 2752555577 | 6 |

| 52 Matl (250-1000 MHz) Common-Mode | Qty |
|---------------------------------------|-----|
| 2752041447 | 12 |
| 2752045447 | 12 |
| 2752051447 | 5 |
| 2752065447 | 5 |

Wound Bead Kit

| Part Number | Kit Description |
|-------------|---|
| 0199000027 | Contains twelve wound beads in two suppression materials, 44 and 61, wound in several configurations. |

| 44 Matl (1-200 MHz) | Turns | Qty |
|---------------------|--------|-----|
| 2944666631 | 3 | 8 |
| 2944666651 | 2 | 8 |
| 2944666661 | 1½ | 8 |
| 2944666671 | 2½ | 8 |
| 2944666681 | 2 x 1½ | 8 |
| 2944777721 | 2 x 2½ | 4 |
| 2944777741 | 4½ | 4 |

| 61 Matl (50-500 MHz) | Turns | Qty |
|----------------------|--------|-----|
| 2961666631 | 3 | 8 |
| 2961666651 | 2 | 8 |
| 2961666661 | 1½ | 8 |
| 2961666671 | 2½ | 8 |
| 2961666681 | 2 x 1½ | 8 |

Quick Link: www.fair-rite.com/kit

Bead-on-Lead Kit

| Part Number | Kit Description |
|-------------|---|
| 0199000028 | Contains three parts each in three materials, 73, 43 and 61, for through hole applications. |

| 73 Matl (< 50 MHz) | Qty |
|--------------------|-----|
| 2773001112 | 15 |
| 2773002112 | 15 |
| 2773009112 | 15 |

| 43 Matl (25-300 MHz) | Qty |
|----------------------|-----|
| 2743001112 | 15 |
| 2743002112 | 15 |
| 2743009112 | 15 |

| 61 Matl (250-1000 MHz) | Qty |
|------------------------|-----|
| 2761001112 | 15 |
| 2761002112 | 15 |
| 2761009112 | 15 |

RF Power Rod Kit

| Part Number | Kit Description |
|-------------|--|
| 0199000029 | Contains a selection of rod sizes intended for differential mode high current applications that require high saturation and Curie temperature. |

| 52 Matl Rods | Qty | OD x Lth (mm) |
|--------------|-----|---------------|
| 4052077111 | 20 | 2.0 x 15.0 |
| 4052098411 | 20 | 2.5 x 15.0 |
| 4052111011 | 20 | 3.0 x 20.0 |
| 4052155611 | 15 | 4.0 x 25.0 |
| 4052195211 | 8 | 5.0 x 25.0 |
| 4052235211 | 5 | 6.0 x 30.0 |
| 4052251111 | 5 | 6.5 x 30.0 |

| 77 Matl Rods | Qty | OD x Lth (mm) |
|--------------|-----|---------------|
| 4077122011 | 15 | 3.2 x 25.4 |
| 4077172011 | 8 | 4.5 x 22.2 |
| 4077296011 | 5 | 6.4 x 31.8 |
| 4077312911 | 9 | 8.0 x 38.1 |
| 4077375411 | 6 | 9.5 x 41.3 |

31 Material Snap-It Kit

| Part Number | Kit Description |
|-------------|---|
| 0199000030 | Contains a range of parts for different cable diameters. Suggested operating frequency 1-300 MHz. |

| 31 Matl Snap-It Assemblies (1 - 300 MHz) | Qty | Max Cable Diameter mm & inches |
|---|-----|-----------------------------------|
| 0431173951 | 4 | 4.90 - 0.193 |
| 0431164951 | 4 | 4.90 - 0.193 |
| 0431164281 | 4 | 6.30 - 0.250 |
| 0431167281 | 4 | 9.85 - 0.388 |
| 0431164181 | 2 | 12.70 - 0.500 |
| 0431176451 | 1 | 18.00 - 0.709 |

Quick Link: www.fair-rite.com/kit

43 Material Snap-It Kit

| Part Number | Kit Description |
|-------------|--|
| 0199000031 | Contains Snap-It assemblies suitable for the 25-300 MHz frequency range. Can accommodate cable diameters from 0.250 to 0.591 inches. |

| 43 Matl Snap-It Assemblies (25-300 MHz) | Qty | Max Cable Diameter mm & inches |
|--|-----|--------------------------------|
| 0443164251 | 2 | 6.30 - 0.250 |
| 0443625006 | 2 | 7.60 - 0.300 |
| 0443665806 | 2 | 9.20 - 0.362 |
| 0443167251 | 2 | 9.85 - 0.388 |
| 0443164151 | 2 | 12.70 - 0.500 |
| 0443800506 | 2 | 12.80 - 0.504 |
| 0443806406 | 2 | 15.00 - 0.591 |

46 Material Core and Snap-It Kit

| Part Number | Kit Description |
|-------------|---|
| 0199000032 | Contains a selection of cable cores and Snap-Its in our economical 46 material. This material has similar performance to our 43/44 grade materials over the 25-300 MHz frequency range. |

| 46 Matl (25-300 MHz) Cable Cores | Qty | Max Cable Diameter mm & inches |
|----------------------------------|-----|--------------------------------|
| 2646480002 | 2 | 4.95 - 0.195 |
| 2646540002 | 2 | 6.10 - 0.240 |
| 2646625102 | 2 | 7.65 - 0.300 |
| 2646665702 | 2 | 9.25 - 0.365 |
| 2646102002 | 2 | 12.55 - 0.495 |
| Snap-It Assemblies | Qty | Max Cable Diameter mm & inches |
| 0446164951 | 2 | 4.90 - 0.193 |
| 0446164281 | 2 | 6.30 - 0.250 |
| 0446167281 | 2 | 9.85 - 0.388 |
| 0446164181 | 2 | 12.70 - 0.500 |

Quick Link: www.fair-rite.com/kit

61 Material Snap-It Kit

| Part Number | Kit Description |
|-------------|--|
| 0199000033 | Contains a selection of 61 material Snap-Its. 61 material is our recommended material for suppressing conducted EMI over the 200-1000 MHz frequency range. |

| 61 Matl Snap-It Assemblies (200 - 1000 MHz) | Qty | Max Cable Diameter mm & inches |
|---|-----|--------------------------------|
| 0461178181 | 4 | 4.10 - 0.161 |
| 0461164951 | 4 | 4.90 - 0.193 |
| 0461164281 | 4 | 6.30 - 0.250 |
| 0461167281 | 4 | 9.85 - 0.388 |
| 0461164181 | 2 | 12.70 - 0.500 |

61 & 31 Material Snap-It Kit

| Part Number | Kit Description |
|-------------|--|
| 0199000017 | Contains a range of parts for different cable diameters. Suppressor selection is suitable for high frequency (61 material) and low frequency (31 material) applications. |

| 31 Matl Snap-It Assemblies (1 - 300 MHz) | Qty | Max Cable Diameter mm & inches |
|--|-----|--------------------------------|
| 0431178181 | 1 | 4.10 - 0.161 |
| 0431164951 | 1 | 4.90 - 0.193 |
| 0431164281 | 1 | 6.30 - 0.250 |
| 0431167281 | 1 | 9.85 - 0.388 |
| 0431164181 | 1 | 12.70 - 0.500 |
| 0431176451 | 1 | 18.00 - 0.709 |

| 61 Matl Snap-It Assemblies (200 - 1000 MHz) | Qty | Max Cable Diameter mm & inches |
|---|-----|--------------------------------|
| 0461178181 | 1 | 4.10 - 0.161 |
| 0461164951 | 1 | 4.90 - 0.193 |
| 0461164281 | 1 | 6.30 - 0.250 |
| 0461167281 | 1 | 9.85 - 0.388 |
| 0461164181 | 1 | 12.70 - 0.500 |
| 0461176451 | 1 | 18.00 - 0.709 |

Multi-Aperture Core Kit

| Part Number | Kit Description |
|-------------|--|
| 0199000036 | Contains five sizes in four materials, 73, 43, 61 and 67. The 73, 43 and 61 material parts are suggested for suppression applications from 1-1000 MHz. The 61 and 67 material parts can be used in HF broadband and inductive designs from 1 MHz to 100 MHz. |

| 73 Material | Qty |
|-------------|-----|
| 2873002302 | 20 |
| 2873002402 | 12 |
| 2873000302 | 4 |
| 2873000202 | 2 |
| 2873006802 | 2 |

| 43 Material | Qty |
|-------------|-----|
| 2843002302 | 20 |
| 2843002402 | 12 |
| 2843001502 | 4 |
| 2843000202 | 2 |
| 2843006802 | 2 |

| 61 Material | Qty |
|-------------|-----|
| 2861002302 | 20 |
| 2861002402 | 12 |
| 2861001502 | 4 |
| 2861000202 | 2 |
| 2861006802 | 2 |

| 67 Material | Qty |
|-------------|-----|
| 2867002302 | 20 |
| 2867002402 | 12 |
| 2867001502 | 4 |
| 2867000102 | 2 |
| 2867006802 | 2 |

Quick Link: www.fair-rite.com/kit

High Frequency Toroid Kit

| Part Number | Kit Description |
|-------------|---|
| 0199000039 | This kit contains a selection of popular toroid sizes in Fair-Rite's high frequency materials. These materials are of the NiZn type with Curie Temps above 200° C. These materials are suitable for broadband and inductive applications from 1 to over 100 MHz |

| Low Permeability 68 Matl (ui=16) | Qty | Low Permeability 67 Matl (ui=40) | Qty | Low Permeability 61 Matl (ui=125) | Qty | Low Permeability 52 Matl (ui=250) | Qty |
|-------------------------------------|-----|-------------------------------------|-----|--------------------------------------|-----|--------------------------------------|-----|
| 5968020901 | 12 | 5967000101 | 12 | 5961000101 | 12 | 5952020201 | 12 |
| 5968000201 | 12 | 5967000201 | 12 | 5961000201 | 12 | 5952020301 | 12 |
| 5968000301 | 6 | 5967000301 | 6 | 5961000301 | 6 | 5952020401 | 6 |
| 5968001101 | 5 | 5967001101 | 5 | 5961001101 | 5 | 5952020501 | 5 |
| 5968001801 | 6 | 5967001801 | 6 | 5961001801 | 6 | 5952020601 | 6 |
| 5968021001 | 5 | 5967001001 | 5 | 5961001001 | 5 | 5952020701 | 5 |
| 5968002701 | 3 | 5967002701 | 3 | 5961002701 | 3 | 5952020801 | 3 |
| 5968003801 | 3 | 5967003801 | 3 | 5961003801 | 3 | 5952003801 | 3 |

Flex Circuit & Ribbon Cable Core Kit

| Part Number | Kit Description |
|-------------|---|
| 0199000038 | This kit contains a selection of single piece and split core geometries for flat cables. All parts are of the 43 Material which provides optimal suppression from 25 to 500 MHz. Sizes range for flat cable widths of 8 to 51 mm. |

| Part Number | Qty | Part Number | Qty | Part Number | Qty | Part Number | Qty |
|-------------|-----|-------------|-----|-------------|-----|-------------|-----|
| 2643180251 | 8 | 2643180351 | 5 | 2643180551 | 6 | 2643173851 | 12 |
| 2643178351 | 8 | 2643178751 | 6 | 2643180651 | 6 | 2643166851 | 6 |
| 2643169552 | 8 | 2643180451 | 16 | 2643180751 | 6 | 2643170951 | 6 |
| 2643178651 | 8 | 2643169351 | 6 | 2643180851 | 12 | 2643168251 | 6 |

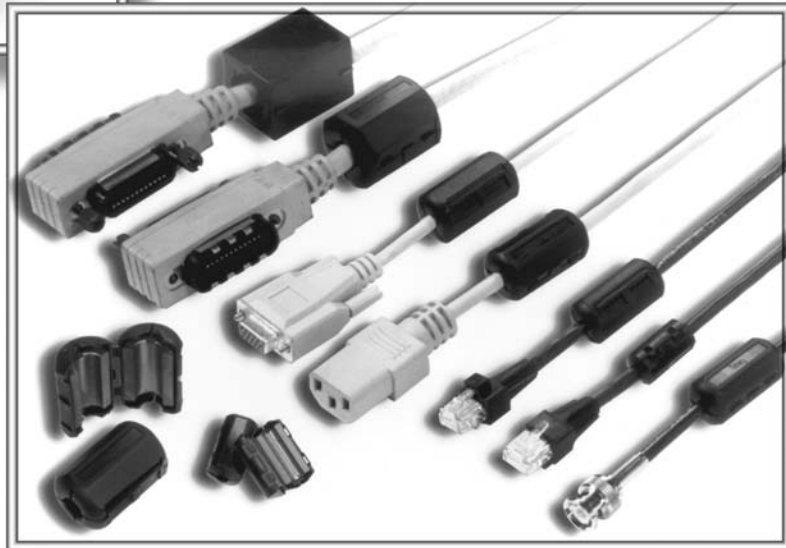
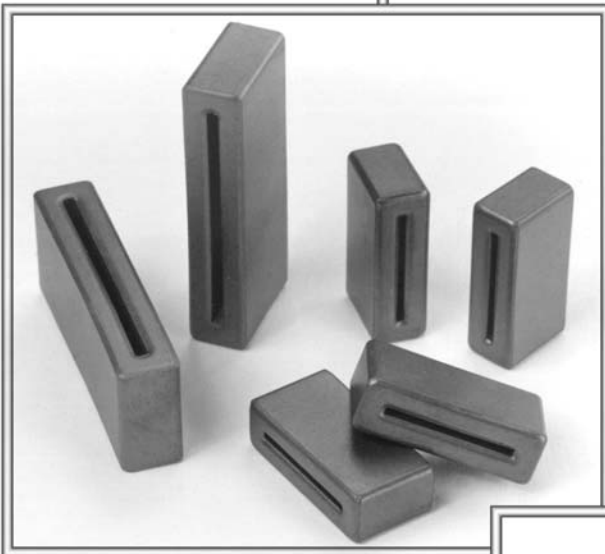
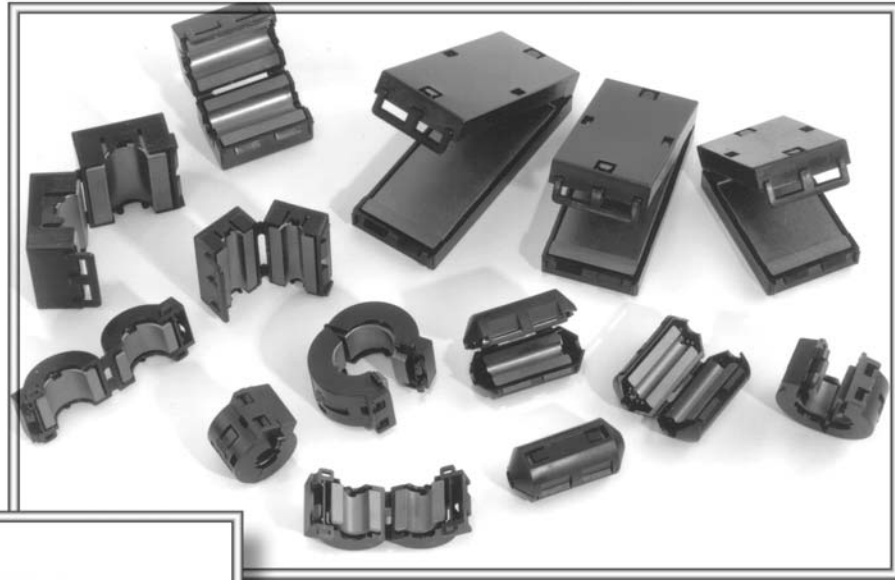

Fair-Rite Products Corp. PO Box 288, One Commercial Row, Wallkill, NY 12589-0288

Phone: (888) FAIR RITE / (845) 895-2055 • Fax: (888) FERRITE / (845) 895-2629 • Web: www.fair-rite.com
(888) 324-7748 (888) 337-7483 E -mail: ferrites@fair-rite.com

Round Cable EMI Suppression Cores

Quick Link: www.fair-rite.com/rcc

Listed by frequency range and in ascending order of "B" dimension.

Fair-Rite offers a broad selection of ferrite EMI suppression cable cores in several materials with guaranteed minimum impedance specifications.

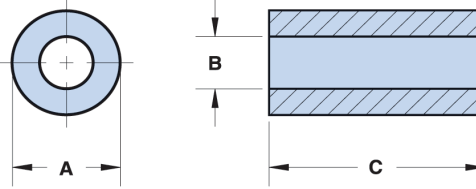

- All cable cores have been burnished to remove the sharp edges.
- The column "H" (Oe) gives for each cable core the calculated dc bias field in oersted for 1 turn and 1 ampere direct current. The actual dc H field in the application, is this value of "H" times the actual NI (ampere-turns) product. For the effect of the dc bias on the impedance of the core material, see the figures 18-23 in the application note "How to Choose Ferrite Components for EMI Suppression".
- Suppression cable cores are controlled for impedances only. Minimum impedance values are specified for the + marked frequencies. The minimum impedance is typically the listed impedance less 20%.
- Single turn impedance tests for 31, 43 and 46 material cores are performed on the 4193A Vector Impedance Meter. The 61 material parts are tested on the 4191A RF Impedance Analyzer and 75 material parts are tested on the 4285A LCR Meter. **Cores are tested with the shortest practical wire length.**
- Performance curves for these suppression components are on our web site.
- For smaller suppression parts, refer to the section "EMI Suppression Beads".
- For any cable suppression core not listed here, feel free to contact our customer service group for availability and pricing.
- The "C" dimension, the core length, can be modified to suit specific applications.
- Our "Expanded Cable and Suppressor Kit" (part number 0199000005) contains a selection of these suppression cores.
- Explanation of Part Numbers: Digits 1&2 = product class, 3&4 = material grade and last digit 2 = burnished.

Legend

Dimensions (Top numbers are in millimeters, bottom numbers are in nominal inches.)

*** Test frequency**

Low Frequency 200 kHz - 30 MHz (75 material)

| Part Number | A | B | C | Wt. (g) | H (Oe) | Impedance (Ω) | | | | |
|-------------|---------------------------|--------------------------|---------------------------|---------|--------|------------------------|---------|-------|-------|-------|
| | | | | | | 200 kHz | 500 kHz | 1 MHz | 2 MHz | 5 MHz |
| 2675023002 | 9.50 \pm 0.25 0.374 | 5.10 \pm 0.25 0.201 | 19.00 \pm 0.45 0.748 | 4.60 | 0.58 | 17 | 43 | 68 | 100 | 96 |
| 2675540202 | 14.30 \pm 0.45 0.563 | 6.35 \pm 0.25 0.250 | 13.45 \pm 0.35 0.530 | 8.30 | 0.43 | 16 | 39 | 58 | 67 | 52 |
| 2675540002 | 14.30 \pm 0.45 0.563 | 6.35 \pm 0.25 0.250 | 28.60 \pm 0.60 1.126 | 17.70 | 0.43 | 30 | 80 | 133 | 154 | 95 |
| 2675625102 | 15.88 \pm 0.38 0.625 | 7.90 \pm 0.40 0.311 | 28.60 \pm 0.60 1.126 | 20.40 | 0.36 | 25 | 60 | 83 | 75 | 50 |
| 2675665702 | 17.40 \pm 0.40 0.685 | 9.50 \pm 0.40 0.374 | 28.60 \pm 0.60 1.126 | 23.00 | 0.32 | 22 | 56 | 102 | 138 | 85 |

Fair-Rite Products Corp. PO Box 288, One Commercial Row, Wallkill, NY 12589-0288

Phone: (888) FAIR RITE / (845) 895-2055 • Fax: (888) FERRITE / (845) 895-2629 • Web: www.fair-rite.com
(888) 324-7748 (888) 337-7483 E-mail: ferrites@fair-rite.com

Round Cable EMI Suppression Cores

Quick Link: www.fair-rite.com/rcc

Listed by frequency range and in ascending order of "B" dimension.

Low Frequency 200 kHz - 30 MHz (75 material)

| Part Number | A | B | C | Wt. (g) | H (Oe) | Impedance (Ω) | | | | |
|-------------|---------------------------|---------------------------|---------------------------|---------|--------|------------------------|---------|-------|-------|-------|
| | | | | | | 200 kHz | 500 kHz | 1 MHz | 2 MHz | 5 MHz |
| 2675626402 | 18.70 \pm 0.50 0.736 | 10.15 \pm 0.40 0.400 | 28.60 \pm 0.60 1.126 | 26.60 | 0.29 | 25 | 62 | 92 | 97 | 67 |
| 2675102002 | 25.90 \pm 0.75 1.020 | 12.80 \pm 0.25 0.504 | 28.60 \pm 0.80 1.126 | 55.00 | 0.22 | 30 | 83 | 120 | 70 | 54 |
| 2675821502 | 31.00 \pm 0.60 1.220 | 19.00 \pm 0.60 0.748 | 15.00 \pm 0.30 0.591 | 34.00 | 0.17 | 11 | 29.5 | 43 | 28 | 20 |

Lower & Broadband Frequencies 1-300 MHz (31 material)

| Part Number | A | B | C | Wt. (g) | H (Oe) | Impedance (Ω) | | | | | |
|-------------|----------------------------|---------------------------|---------------------------|---------|--------|------------------------|-------|---------------------|---------------------|----------------------|---------|
| | | | | | | 1 MHz | 5 MHz | 10 MHz ⁺ | 25 MHz ⁺ | 100 MHz ⁺ | 250 MHz |
| 2631250202 | 6.35 \pm 0.15 0.250 | 2.95 \pm 0.45 0.125 | 25.40 \pm 0.75 1.000 | 2.90 | 0.91 | 27 | 70 | 90 | 138 | 230 | 240 |
| 2631023002 | 9.50 \pm 0.25 0.375 | 4.75 \pm 0.30 0.193 | 19.05 \pm 0.70 0.750 | 4.70 | 0.60 | 19 | 49 | 62 | 95 | 160 | 185 |
| 2631480102 | 12.30 \pm 0.40 0.485 | 4.95 \pm 0.25 0.200 | 12.70 \pm 0.40 0.500 | 6.00 | 0.52 | 18 | 45 | 58 | 88 | 140 | 167 |
| 2631480002 | 12.30 \pm 0.40 0.485 | 4.95 \pm 0.25 0.200 | 25.40 \pm 0.75 1.000 | 12.00 | 0.52 | 34 | 88 | 115 | 175 | 295 | 267 |
| 2631540202 | 14.30 \pm 0.45 0.562 | 6.35 \pm 0.25 0.250 | 13.80 \pm 0.70 0.530 | 8.30 | 0.43 | 17 | 44 | 58 | 88 | 140 | 160 |
| 2631540002 | 14.30 \pm 0.45 0.562 | 6.35 \pm 0.25 0.250 | 28.60 \pm 0.75 1.125 | 17.70 | 0.43 | 35 | 91 | 119 | 181 | 300 | 280 |
| 2631625002 | 16.25 \pm 0.75 0.625 | 7.90 \pm 0.25 0.312 | 14.30 \pm 0.35 0.562 | 10.30 | 0.36 | 16 | 40 | 53 | 75 | 130 | 150 |
| 2631625102 | 16.25 \pm 0.75 0.625 | 7.90 \pm 0.25 0.312 | 28.60 \pm 0.75 1.125 | 20.50 | 0.36 | 30 | 79 | 103 | 156 | 260 | 268 |
| 2631665702 | 17.45 \pm 0.40 0.687 | 9.50 \pm 0.25 0.375 | 28.60 \pm 0.75 1.125 | 23.10 | 0.32 | 27 | 69 | 89 | 138 | 225 | 265 |
| 2631626302 | 18.70 \pm 0.50 0.735 | 10.15 \pm 0.25 0.400 | 14.65 \pm 0.75 0.562 | 13.30 | 0.29 | 14 | 35 | 44 | 69 | 115 | 140 |
| 2631626402 | 18.70 \pm 0.50 0.735 | 10.15 \pm 0.25 0.400 | 28.60 \pm 0.75 1.125 | 26.60 | 0.29 | 27 | 69 | 89 | 138 | 225 | 235 |
| 2631102002 | 25.90 \pm 0.75 1.020 | 12.80 \pm 0.25 0.505 | 28.60 \pm 0.80 1.125 | 55.00 | 0.22 | 31 | 79 | 103 | 156 | 260 | 280 |
| 2631101902 | 28.50 \pm 0.60 1.122 | 13.80 \pm 0.40 0.543 | 28.60 \pm 0.80 1.125 | 68.00 | 0.21 | 32 | 82 | 106 | 163 | 270 | 300 |
| 2631801202 | 29.00 \pm 0.75 1.142 | 19.00 \pm 0.50 0.748 | 13.85 \pm 0.40 0.545 | 25.00 | 0.17 | 10 | 24 | 31 | 49 | 88 | 130 |
| 2631103002 | 31.60 \pm 0.75 1.244 | 19.55 \pm 0.50 0.770 | 50.80 \pm 1.00 2.000 | 116.00 | 0.17 | 37 | 98 | 120 | 205 | 340 | 315 |
| 2631626202 | 50.80 \pm 1.30 2.000 | 25.40 \pm 0.80 1.000 | 38.10 \pm 0.75 1.500 | 278.00 | 0.11 | 40 | 103 | 140 | 215 | 365 | 290 |
| 2631803802 | 61.00 \pm 1.30 2.400 | 35.55 \pm 0.85 1.400 | 12.70 \pm 0.50 0.500 | 118.00 | 0.09 | 12 | 28 | 40 | 63 | 119 | 215 |
| 2631814002 | 101.60 \pm 2.60 4.000 | 76.20 \pm 2.00 3.000 | 25.40 \pm 0.70 1.000 | 420.00 | 0.05 | 14 | 31 | 45 | 76 | 175 | 500 |

Fair-Rite Products Corp. PO Box 288, One Commercial Row, Wallkill, NY 12589-0288

Round Cable EMI Suppression Cores

Quick Link: www.fair-rite.com/rcc

Listed by frequency range and in ascending order of "B" dimension.

Broadband Frequencies 25-300 MHz (43 material)

| Part Number | A | B | C | Wt. (g) | H (Oe) | Impedance (Ω) | | | |
|-------------|----------------------|----------------------|----------------------|---------|--------|------------------------|---------------------|----------------------|---------|
| | | | | | | 10 MHz | 25 MHz ⁺ | 100 MHz ⁺ | 250 MHz |
| 2643480102 | 12.30 ±0.40 0.485 | 4.95 +0.25 0.200 | 12.70 ±0.40 0.500 | 6.00 | 0.52 | 52 | 84 | 121 | 145 |
| 2643480002 | 12.30 ±0.40 0.485 | 4.95 ±0.25 0.200 | 25.40 ±0.75 1.000 | 12.00 | 0.52 | 102 | 165 | 236 | 233 |
| 2643540702 | 14.30 ±0.45 0.562 | 6.35 ±0.25 0.250 | 5.30 -0.45 0.200 | 3.10 | 0.43 | 20 | 30 | 50 | 68 |
| 2643540102 | 14.30 ±0.45 0.562 | 6.35 ±0.25 0.250 | 10.15 ±0.40 0.400 | 6.30 | 0.43 | 39 | 61 | 89 | 104 |
| 2643540202 | 14.30 ±0.45 0.562 | 6.35 ±0.25 0.250 | 13.80 -0.70 0.530 | 8.30 | 0.43 | 51 | 78 | 118 | 140 |
| 2643540002 | 14.30 ±0.45 0.562 | 6.35 ±0.25 0.250 | 28.60 ±0.75 1.125 | 17.70 | 0.43 | 105 | 171 | 250 | 255 |
| 2643540302 | 14.30 ±0.45 0.562 | 7.10 ±0.25 0.280 | 15.25 ±0.40 0.600 | 8.90 | 0.41 | 50 | 75 | 118 | 137 |
| 2643800302 | 12.70 ±0.25 0.500 | 7.15 ±0.20 0.282 | 4.90 -0.25 0.188 | 2.00 | 0.43 | 15 | 26 | 42 | 59 |
| 2643540402 | 14.30 ±0.45 0.562 | 7.25 ±0.20 0.286 | 28.60 ±0.75 1.125 | 16.00 | 0.40 | 88 | 143 | 215 | 230 |
| 2643801102 | 12.70 ±0.25 0.500 | 7.90 ±0.20 0.312 | 6.35 ±0.20 0.250 | 2.40 | 0.40 | 16 | 26 | 41 | 59 |
| 2643801902 | 12.70 ±0.25 0.500 | 7.90 ±0.20 0.312 | 12.70 ±0.40 0.500 | 4.70 | 0.40 | 29 | 44 | 73 | 91 |
| 2643625002 | 16.25 -0.75 0.625 | 7.90 ±0.25 0.312 | 14.30 ±0.35 0.562 | 10.30 | 0.36 | 45 | 70 | 113 | 135 |
| 2643625102 | 16.25 -0.75 0.625 | 7.90 ±0.25 0.312 | 28.60 ±0.75 1.125 | 20.50 | 0.36 | 90 | 130 | 213 | 240 |
| 2643625202 | 15.90 ±0.40 0.625 | 7.90 ±0.30 0.312 | 50.80 ±1.00 2.000 | 36.00 | 0.36 | 158 | 235 | 384 | 305 |
| 2643665902 | 17.45 ±0.40 0.687 | 9.50 ±0.25 0.375 | 6.35 ±0.25 0.250 | 5.10 | 0.32 | 19 | 26 | 44 | 62 |
| 2643665802 | 17.45 ±0.40 0.687 | 9.50 ±0.25 0.375 | 12.70 ±0.50 0.500 | 10.30 | 0.32 | 35 | 55 | 88 | 108 |
| 2643665702 | 17.45 ±0.40 0.687 | 9.50 ±0.25 0.375 | 28.60 ±0.75 1.125 | 23.10 | 0.32 | 78 | 125 | 200 | 255 |
| 2643626302 | 18.70 ±0.50 0.735 | 10.15 ±0.25 0.400 | 14.65 -0.75 0.562 | 13.30 | 0.29 | 41 | 63 | 96 | 123 |
| 2643626402 | 18.70 ±0.50 0.735 | 10.15 ±0.25 0.400 | 28.60 ±0.75 1.125 | 26.60 | 0.29 | 79 | 128 | 196 | 220 |
| 2643626502 | 18.70 ±0.60 0.735 | 10.15 ±0.40 0.400 | 50.80 ±1.00 2.000 | 47.00 | 0.29 | 138 | 225 | 348 | 405 |
| 2643801502 | 25.40 ±0.65 1.000 | 12.70 ±0.35 0.500 | 6.35 ±0.25 0.250 | 11.60 | 0.23 | 22 | 34 | 53 | 87 |
| 2643102402 | 25.90 ±0.75 1.020 | 12.80 ±0.25 0.505 | 21.30 ±0.50 0.840 | 41.00 | 0.22 | 68 | 110 | 183 | 230 |
| 2643102002 | 25.90 ±0.75 1.020 | 12.80 ±0.25 0.505 | 28.60 ±0.80 1.125 | 55.00 | 0.22 | 91 | 145 | 235 | 275 |
| 2643800602 | 20.95 ±0.40 0.825 | 13.20 ±0.30 0.520 | 6.35 ±0.20 0.250 | 6.30 | 0.24 | 16 | 24 | 44 | 67 |
| 2643800502 | 20.95 ±0.40 0.825 | 13.20 ±0.30 0.520 | 11.90 ±0.40 0.468 | 11.90 | 0.24 | 27 | 45 | 82 | 115 |
| 2643801802 | 22.10 ±0.40 0.870 | 13.70 ±0.30 0.540 | 6.35 ±0.20 0.250 | 7.20 | 0.23 | 15 | 25 | 45 | 70 |
| 2643101902 | 28.50 ±0.60 1.122 | 13.80 ±0.30 0.543 | 28.60 ±0.80 1.125 | 67.00 | 0.21 | 93 | 145 | 230 | 290 |
| 2643801402 | 25.40 ±0.60 1.000 | 15.50 ±0.50 0.610 | 8.10 ±0.30 0.320 | 12.40 | 0.20 | 20 | 35 | 55 | 95 |
| 2643806402 | 25.40 ±0.60 1.000 | 15.50 ±0.50 0.610 | 12.70 ±0.40 0.500 | 19.40 | 0.20 | 30 | 53 | 90 | 130 |
| 2643251002 | 39.10 ±0.75 1.540 | 16.75 ±0.50 0.660 | 22.20 ±0.80 0.875 | 104.00 | 0.16 | 85 | 135 | 230 | 325 |

Fair-Rite Products Corp. PO Box 288, One Commercial Row, Wallkill, NY 12589-0288

Phone: (888) FAIR RITE / (845) 895-2055 • Fax: (888) FERRITE / (845) 895-2629 • Web: www.fair-rite.com
 (888) 324-7748 (888) 337-7483 E-mail: ferrites@fair-rite.com

Round Cable EMI Suppression Cores

Quick Link: www.fair-rite.com/rcc

Listed by frequency range and in ascending order of "B" dimension.

Broadband Frequencies 25-300 MHz (43 material)

| Part Number | A | B | C | Wt. (g) | H (Oe) | Impedance (Ω) | | | |
|-------------|-----------------------|----------------------|----------------------|---------|--------|---------------|---------------------|----------------------|---------|
| | | | | | | 10 MHz | 25 MHz ⁺ | 100 MHz ⁺ | 250 MHz |
| 2643801002 | 29.00 ±0.75 1.142 | 19.00 ±0.50 0.748 | 7.50 ±0.25 0.295 | 13.60 | 0.17 | 17 | 28 | 47 | 80 |
| 2643801202 | 29.00 ±0.75 1.142 | 19.00 ±0.50 0.748 | 13.85 ±0.40 0.545 | 25.10 | 0.17 | 28 | 51 | 92 | 142 |
| 2643804502 | 31.10 ±0.75 1.225 | 19.05 ±0.50 0.750 | 16.30 -0.75 0.627 | 36.00 | 0.17 | 37 | 60 | 100 | 153 |
| 2643103002 | 31.10 ±0.85 1.225 | 19.05 ±0.60 0.750 | 50.80 ±1.00 2.000 | 116.00 | 0.17 | 105 | 195 | 330 | 310 |
| 2643802702 | 35.55 ±0.75 1.400 | 22.85 ±0.50 0.900 | 12.70 ±0.50 0.500 | 36.00 | 0.14 | 28 | 48 | 80 | 135 |
| 2643626102 | 50.80 ±1.00 2.000 | 25.40 ±0.50 1.000 | 25.40 ±0.75 1.000 | 190.00 | 0.11 | 80 | 128 | 224 | 310 |
| 2643625902 | 50.80 ±1.00 2.000 | 25.40 ±0.50 1.000 | 28.70 ±0.75 1.130 | 215.00 | 0.11 | 90 | 145 | 254 | 373 |
| 2643626202 | 50.80 ±1.30 2.000 | 25.40 ±0.80 1.000 | 38.10 ±0.75 1.500 | 285.00 | 0.11 | 118 | 193 | 336 | 280 |
| 2643626002 | 50.80 ±1.30 2.000 | 25.40 ±0.80 1.000 | 50.80 ±1.00 2.000 | 380.00 | 0.11 | 157 | 240 | 360 | 257 |
| 2643803802 | 61.00 ±1.30 2.400 | 35.55 ±0.85 1.400 | 12.70 ±0.50 0.500 | 118.00 | 0.09 | 33 | 58 | 108 | 218 |
| 2643814002 | 101.60 ±2.60 4.000 | 76.20 ±2.00 3.000 | 25.40 ±0.70 1.000 | 420.00 | 0.05 | 46 | 75 | 169 | 400 |

Broadband Frequencies 25-300 MHz (Economical 46 material)

| Part Number | A | B | C | Wt. (g) | H (Oe) | Impedance (Ω) | | | |
|-------------|----------------------|----------------------|----------------------|---------|--------|---------------|--------|----------------------|---------|
| | | | | | | 10 MHz | 25 MHz | 100 MHz ⁺ | 250 MHz |
| 2646480102 | 12.30 ±0.40 0.485 | 4.95 ±0.25 0.200 | 12.70 ±0.40 0.500 | 6.00 | 0.52 | 42 | 62 | 110 | 145 |
| 2646480002 | 12.30 ±0.40 0.485 | 4.95 ±0.25 0.200 | 25.40 ±0.75 1.000 | 12.00 | 0.52 | 83 | 125 | 212 | 233 |
| 2646540202 | 14.30 ±0.45 0.562 | 6.35 ±0.25 0.250 | 13.80 -0.70 0.530 | 8.30 | 0.43 | 45 | 66 | 106 | 127 |
| 2646540002 | 14.30 ±0.45 0.562 | 6.35 ±0.25 0.250 | 28.60 ±0.75 1.125 | 17.70 | 0.43 | 89 | 134 | 225 | 253 |
| 2646625002 | 16.25 -0.75 0.625 | 7.90 ±0.25 0.312 | 14.30 ±0.35 0.562 | 10.30 | 0.36 | 44 | 63 | 102 | 135 |
| 2646625102 | 16.25 -0.75 0.625 | 7.90 ±0.25 0.312 | 28.60 ±0.75 1.125 | 20.50 | 0.36 | 78 | 115 | 192 | 235 |
| 2646625202 | 15.90 ±0.40 0.625 | 7.90 ±0.30 0.312 | 50.80 ±1.00 2.000 | 36.00 | 0.36 | 138 | 204 | 345 | 270 |
| 2646665802 | 17.45 ±0.40 0.687 | 9.50 ±0.25 0.375 | 12.70 ±0.50 0.500 | 10.30 | 0.32 | 32 | 49 | 79 | 110 |
| 2646665702 | 17.45 ±0.40 0.687 | 9.50 ±0.25 0.375 | 28.60 ±0.75 1.125 | 23.10 | 0.32 | 72 | 106 | 180 | 225 |
| 2646626402 | 18.70 ±0.50 0.736 | 10.15 ±0.25 0.400 | 28.60 ±0.75 1.125 | 26.60 | 0.29 | 70 | 110 | 170 | 210 |
| 2646102402 | 25.90 ±0.75 1.020 | 12.80 ±0.25 0.505 | 21.30 ±0.50 0.840 | 41.00 | 0.22 | 67 | 100 | 165 | 218 |
| 2646102002 | 25.90 ±0.75 1.020 | 12.80 ±0.25 0.505 | 28.60 ±0.80 1.125 | 55.00 | 0.22 | 74 | 118 | 212 | 268 |
| 2646101902 | 28.50 ±0.60 1.122 | 13.80 ±0.30 0.543 | 28.60 ±0.80 1.125 | 67.00 | 0.21 | 80 | 121 | 207 | 285 |
| 2646804502 | 31.10 ±0.75 1.225 | 19.05 ±0.50 0.750 | 16.30 -0.75 0.627 | 36.00 | 0.17 | 33 | 49 | 90 | 150 |

Fair-Rite Products Corp. PO Box 288, One Commercial Row, Wallkill, NY 12589-0288

Round Cable EMI Suppression Cores

Quick Link: www.fair-rite.com/rcc

Listed by frequency range and in ascending order of "B" dimension.

Broadband Frequencies 25-300 MHz (Economical 46 material)

| Part Number | A | B | C | Wt. (g) | H (Oe) | Impedance (Ω) | | | |
|-------------|---------------------------|---------------------------|---------------------------|---------|--------|------------------------|--------|----------------------|---------|
| | | | | | | 10 MHz | 25 MHz | 100 MHz ⁺ | 250 MHz |
| 2646626202 | 50.80 \pm 1.30 2.000 | 25.40 \pm 0.80 1.000 | 38.10 \pm 0.75 1.500 | 285.00 | 0.11 | 102 | 165 | 302 | 280 |
| 2646803802 | 61.00 \pm 1.30 2.400 | 35.55 \pm 0.85 1.400 | 12.70 \pm 0.50 0.500 | 118.00 | 0.09 | 30 | 44 | 100 | 200 |

Higher Frequencies 200-1000 MHz (61 material)

| Part Number | A | B | C | Wt. (g) | H (Oe) | Impedance (Ω) | | | |
|-------------|---------------------------|---------------------------|---------------------------|---------|--------|------------------------|----------------------|----------------------|----------|
| | | | | | | 100 MHz | 250 MHz ⁺ | 500 MHz ⁺ | 1000 MHz |
| 2661480002 | 12.30 \pm 0.40 0.485 | 4.95 \pm 0.20 0.200 | 25.40 \pm 0.75 1.000 | 12.00 | 0.52 | 210 | 325 | 395 | 415 |
| 2661540202 | 14.30 \pm 0.45 0.562 | 6.35 \pm 0.25 0.250 | 13.80 -0.70 0.530 | 8.30 | 0.43 | 100 | 145 | 185 | 260 |
| 2661540002 | 14.30 \pm 0.45 0.562 | 6.35 \pm 0.25 0.250 | 28.60 \pm 0.75 1.125 | 17.70 | 0.43 | 205 | 295 | 370 | 350 |
| 2661801902 | 12.70 \pm 0.25 0.500 | 7.90 \pm 0.25 0.312 | 12.70 \pm 0.40 0.500 | 4.70 | 0.40 | 45 | 70 | 105 | 175 |
| 2661665702 | 17.45 \pm 0.40 0.687 | 9.50 \pm 0.25 0.375 | 28.60 \pm 0.75 1.125 | 23.10 | 0.32 | 190 | 280 | 360 | 450 |
| 2661626402 | 19.00 -0.65 0.735 | 10.15 \pm 0.25 0.400 | 28.60 \pm 0.75 1.125 | 26.60 | 0.29 | 185 | 250 | 370 | 460 |
| 2661102402 | 25.90 \pm 0.75 1.020 | 12.80 \pm 0.25 0.505 | 21.30 \pm 0.50 0.840 | 41.00 | 0.22 | 125 | 200 | 310 | 550 |
| 2661102002 | 25.90 \pm 0.75 1.020 | 12.80 \pm 0.25 0.505 | 28.60 \pm 0.80 1.125 | 55.00 | 0.22 | 190 | 300 | 380 | 400 |

Fair-Rite Products Corp. PO Box 288, One Commercial Row, Wallkill, NY 12589-0288

Phone: (888) FAIR RITE / (845) 895-2055 • Fax: (888) FERRITE / (845) 895-2629 • Web: www.fair-rite.com
(888) 324-7748 (888) 337-7483 E-mail: ferrites@fair-rite.com

Round cable snap-its can easily accommodate round cables or bundled wires with diameters from 2.5 mm (0.100") to 25.4 mm (1.000"). These assemblies are available in four ferrite material classes to suppress differential or common-mode conducted EMI from 1 MHz into the GHz region. The polypropylene cases are meeting the RoHS restrictions of hazardous substances and have a flammability rating of UL 94 V-0.

- Round cable snap-it assemblies are controlled for impedances only. Minimum impedance values are specified for the + marked frequencies. The minimum impedance is typically the listed impedance less 20%.
- Single turn impedance tests for the 31, 43/44 and 46 material parts are performed on the 4193A Vector Impedance Analyzer. The 61 material parts are tested on the 4291A RF Impedance Analyzer and 75 material parts are tested on the 4285A LCR Meter..
Cores are tested with the shortest practical wire length.
- Performance curves for these suppression components are our web site.
- Many of the snap-it parts have round core equivalents. See "Round Cable EMI Suppression Cores".
- The "B" dimension is the core inside diameter.
- Round Cable Snap-It Kits are available for each of the four suppression materials. 31 Snap-It Kit (0199000030), 43 Snap-It Kit (0199000031), 46 Core and Snap-It Kit (0199000032) and 61 Snap-It Kit (0199000033).
- Explanation of Part Numbers: Digits 1&2 = product class and 3&4 = material grade.

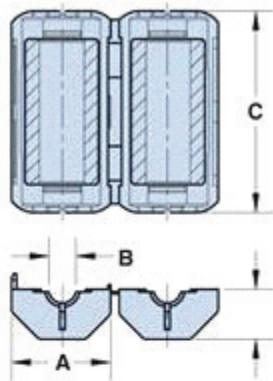

Figure 1

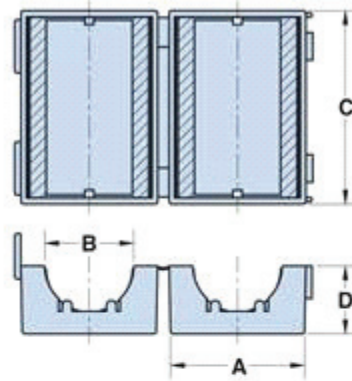

Figure 2

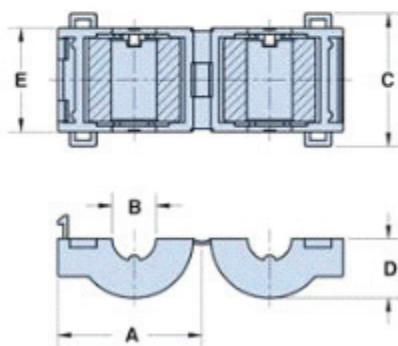

Figure 3

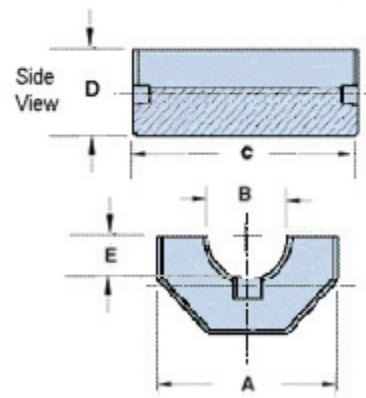

Figure 4

Round Cable Snap-Its



Quick Link: www.fair-rite.com/rcs

Listed by frequency range and in ascending order of cable diameter.

Legend

Dimensions (Top numbers are in millimeters, bottom numbers are in nominal inches.)

* Test frequency

Low Frequency 200 kHz - 30 MHz (75 material)

| Part Number | Fig. | Max. Cable Diameter | A | B | C | D | Wt. (g) | Impedance (Ω) | | | | | Solid Equivalent |
|-------------|------|---------------------|----------------|----------------|----------------|----------------|---------|------------------------|---------|-------|-------|-------|------------------|
| | | | | | | | | 200 kHz | 500 kHz | 1 MHz | 2 MHz | 5 MHz | |
| 0475181651 | 2 | 4.09 0.193 | 13.00 0.512 | 5.10 0.201 | 23.00 0.906 | 6.05 0.238 | 6.50 | 14 | 35 | 66 | 108 | 110 | 2675023002 |
| 0475164281 | 1 | 6.30 0.248 | 20.00 0.787 | 6.60 0.260 | 39.50 1.555 | 10.00 0.394 | 26.00 | 19 | 49 | 102 | 172 | 110 | 2675540002 |
| 0475178281 | 1 | 8.70 0.343 | 21.00 0.827 | 9.00 0.354 | 39.40 1.551 | 10.50 0.413 | 23.00 | 18 | 46 | 87 | 115 | 74 | 2675665702 |
| 0475167281 | 1 | 9.85 0.388 | 23.00 0.906 | 10.15 0.400 | 39.50 1.555 | 11.70 0.461 | 33.00 | 17 | 47 | 92 | 110 | 67 | 2675626402 |
| 0475164181 | 1 | 12.7 0.500 | 30.00 1.181 | 13.05 0.514 | 39.50 1.555 | 15.50 0.610 | 61.00 | 20 | 58 | 102 | 70 | 50 | 2675102002 |
| 0475176451 | 1 | 18.00 0.709 | 38.50 1.516 | 18.70 0.736 | 47.50 1.870 | 19.15 0.754 | 161.00 | 30 | 92 | 130 | 81 | 66 | - |

Lower & Broadband Frequencies 1-300 MHz (31 material)

| Part Number | Fig. | Max. Cable Diameter | A | B | C | D | Wt. (g) | Impedance (Ω) | | | | | | Solid Equivalent |
|-------------|------|---------------------|---------------------------|---------------------------|---------------------------|---------------------------|---------|------------------------|-------|---------------------|---------------------|----------------------|---------|------------------|
| | | | | | | | | 1 MHz | 5 MHz | 10 MHz ⁺ | 25 MHz ⁺ | 100 MHz ⁺ | 250 MHz | |
| 0431178181 | 1 | 4.10 0.161 | 11.80 0.465 | 4.30 0.169 | 23.20 0.913 | 5.60 0.221 | 4.20 | 12 | 43 | 60 | 90 | 160 | 183 | - |
| 0431173951 | 1 | 4.90 0.193 | 12.80 0.504 | 5.10 0.201 | 25.00 0.984 | 5.60 0.220 | 6.50 | 14 | 44 | 60 | 100 | 180 | 208 | 2631023002 |
| 0431164951 | 1 | 4.90 0.193 | 17.30 0.680 | 5.10 0.201 | 36.20 1.420 | 8.40 0.331 | 17.00 | 25 | 75 | 100 | 169 | 280 | 247 | 2631480002 |
| 0431164281 | 1 | 6.30 0.250 | 20.00 0.788 | 6.60 0.260 | 39.40 1.550 | 9.80 0.385 | 26.00 | 28 | 83 | 105 | 180 | 310 | 240 | 2631540002 |
| 0431178281 | 1 | 8.70 0.343 | 21.50 0.846 | 9.00 0.354 | 39.40 1.550 | 10.55 0.415 | 23.00 | 18 | 63 | 85 | 130 | 250 | 275 | 2631665702 |
| 0431167281 | 1 | 9.85 0.388 | 23.70 0.933 | 10.15 0.400 | 39.40 1.550 | 11.70 0.461 | 33.00 | 18 | 56 | 81 | 144 | 240 | 270 | 2631626402 |
| 0431164181 | 1 | 12.70 0.500 | 31.00 1.220 | 13.05 0.514 | 39.40 1.550 | 15.25 0.600 | 61.00 | 25 | 71 | 100 | 156 | 260 | 260 | 2631102002 |
| 0431176451 | 1 | 18.00 0.709 | 38.60 1.520 | 18.35 0.722 | 47.50 1.870 | 19.15 0.755 | 161.00 | 47 | 95 | 130 | 225 | 380 | 370 | 2631103002 |
| 0431173551 | 2 | 18.50 0.728 | 29.20 1.150 | 18.80 0.740 | 42.00 1.650 | 14.70 0.579 | 78.00 | 16 | 48 | 69 | 125 | 220 | 310 | - |
| 0431177081 | 1 | 25.15 0.990 | 56.40 2.220 | 25.65 1.010 | 42.95 1.690 | 27.45 1.080 | 308.00 | 45 | 90 | 125 | 218 | 375 | 340 | 2631626202 |
| 2631181381 | 4 | 35.4 1.394 | 62.10 \pm 1.00 2.445 | 37.20 \pm 0.64 1.465 | 63.50 \pm 1.50 2.500 | 30.20 \pm 0.31 1.190 | 289.00 | 60 | 150 | 190 | 290 | 490 | 530 | - |

Broadband Frequencies 25-300 MHz (43 & 44 materials)

| Part Number | Fig. | Max. Cable Diameter | A | B | C | D | E | Wt. (g) | Impedance (Ω) | | | | Solid Equivalent |
|-------------|------|---------------------|----------------|---------------|----------------|---------------|---|---------|------------------------|---------------------|----------------------|---------|------------------|
| | | | | | | | | | 10 MHz | 25 MHz ⁺ | 100 MHz ⁺ | 250 MHz | |
| 0443178181 | 1 | 4.10 0.161 | 11.80 0.465 | 4.30 0.169 | 23.20 0.913 | 5.60 0.221 | - | 4.20 | 40 | 70 | 125 | 152 | - |
| 0444173951 | 1 | 4.90 0.193 | 12.80 0.504 | 5.10 0.201 | 25.00 0.984 | 5.60 0.220 | - | 6.50 | 54 | 94 | 150 | 187 | 2643023002 |

Fair-Rite Products Corp. PO Box 288, One Commercial Row, Wallkill, NY 12589-0288

Phone: (888) FAIR RITE / (845) 895-2055 • Fax: (888) FERRITE / (845) 895-2629 • Web: www.fair-rite.com
 (888) 324-7748 (888) 337-7483 E-mail: ferrites@fair-rite.com

Round Cable Snap-Its



Quick Link: www.fair-rite.com/rcs

Listed by frequency range and in ascending order of cable diameter.

Broadband Frequencies 25-300 MHz (43 & 44 materials)

| Part Number | Fig. | Max. Cable Diameter | A | B | C | D | E | Wt. (g) | Impedance (Ω) | | | | Solid Equivalent |
|-------------|------|---------------------|-----------------------|-----------------------|-----------------------|-----------------------|------------------------|---------|---------------|---------------------|----------------------|---------|------------------|
| | | | | | | | | | 10 MHz | 25 MHz ⁺ | 100 MHz ⁺ | 250 MHz | |
| 0444164951 | 1 | 4.90 0.193 | 17.30 0.680 | 5.10 0.201 | 36.20 1.420 | 8.40 0.331 | - | 17.00 | 90 | 144 | 245 | 257 | 2643480002 |
| 0443164251 | 2 | 6.30 0.250 | 17.90 0.705 | 6.60 0.260 | 32.20 1.270 | 9.20 0.362 | - | 31.00 | 100 | 163 | 275 | 275 | 2643540002 |
| 0444164281 | 1 | 6.30 0.250 | 20.00 0.788 | 6.60 0.260 | 39.40 1.550 | 9.80 0.385 | - | 26.00 | 95 | 156 | 260 | 270 | 2643540002 |
| 0443625006 | 3 | 7.60 0.299 | 24.70 0.972 | 7.90 0.311 | 22.80 0.898 | 10.20 0.402 | 17.80 0.701 | 13.00 | 27 | 50 | 113 | 188 | 2643625002 |
| 0443178281 | 1 | 8.70 0.343 | 21.50 0.846 | 9.00 0.354 | 39.40 1.550 | 10.55 0.415 | - | 24.00 | 65 | 120 | 230 | 265 | 2643665702 |
| 0443665806 | 3 | 9.20 0.362 | 26.30 1.035 | 9.50 0.374 | 21.40 0.843 | 11.00 0.433 | 16.40 0.646 | 13.00 | 23 | 41 | 88 | 122 | 2643665802 |
| 0443167251 | 2 | 9.85 0.388 | 22.10 0.870 | 10.15 0.400 | 32.30 1.272 | 11.00 0.433 | - | 42.00 | 79 | 138 | 225 | 285 | 2643626402 |
| 0444167281 | 1 | 9.85 0.388 | 23.70 0.933 | 10.15 0.400 | 39.40 1.550 | 11.70 0.460 | - | 33.00 | 77 | 125 | 210 | 260 | 2643626402 |
| 0443164151 | 2 | 12.70 0.500 | 29.00 1.142 | 13.05 0.514 | 32.50 1.280 | 14.80 0.583 | - | 84.00 | 90 | 156 | 250 | 305 | 2643102002 |
| 0444164181 | 1 | 12.70 0.500 | 31.00 1.220 | 13.05 0.514 | 39.40 1.550 | 15.25 0.600 | - | 61.00 | 76 | 138 | 230 | 280 | 2643102002 |
| 0443800506 | 3 | 12.80 0.504 | 29.70 1.169 | 13.20 0.520 | 20.60 0.811 | 12.70 0.500 | 15.60 0.614 | 16.00 | 18 | 35 | 75 | 120 | 2643800502 |
| 0443806406 | 3 | 15.00 0.591 | 34.30 1.360 | 15.50 0.610 | 21.20 0.835 | 15.00 0.591 | 16.20 0.638 | 23.00 | 24 | 43 | 90 | 147 | 2643806402 |
| 0444176451 | 1 | 18.00 0.709 | 38.60 1.520 | 18.35 0.722 | 47.50 1.870 | 19.15 0.755 | - | 161.00 | 100 | 175 | 365 | 365 | 2643103002 |
| 0444173551 | 2 | 18.50 0.728 | 29.20 1.150 | 18.80 0.740 | 42.00 1.650 | 14.70 0.579 | - | 78.00 | 50 | 95 | 195 | 322 | 2643103102 |
| 0444177081 | 1 | 25.15 0.990 | 56.40 2.220 | 25.65 1.010 | 42.95 1.690 | 27.45 1.080 | - | 308.00 | 115 | 194 | 335 | 330 | 2643626202 |
| 2644181281 | 4 | 33.0 1.300 | 61.00 ± 1.30 2.402 | 37.20 ± 0.90 1.465 | 12.70 ± 0.65 0.500 | 29.60 ± 0.35 1.165 | 16.50 MIN 0.650 MIN | 63.00 | 35 | 56 | 104 | 170 | 2643803802 |

Broadband Frequencies 25-300 MHz (Economical 46 material)

| Part Number | Fig. | Max. Cable Diameter | A | B | C | D | Wt. (g) | Impedance (Ω) | | | | Solid Equivalent |
|-------------|------|---------------------|----------------|----------------|----------------|----------------|---------|---------------|--------|----------------------|---------|------------------|
| | | | | | | | | 10 MHz | 25 MHz | 100 MHz ⁺ | 250 MHz | |
| 0446173951 | 1 | 4.90 0.193 | 12.80 0.504 | 5.10 0.201 | 25.00 0.984 | 5.60 0.220 | 6.50 | 46 | 82 | 135 | 185 | - |
| 0446164951 | 1 | 4.90 0.193 | 17.30 0.680 | 5.10 0.201 | 38.20 1.420 | 8.40 0.331 | 17.00 | 72 | 120 | 220 | 250 | 2646480002 |
| 0446164281 | 1 | 6.30 0.250 | 20.00 0.788 | 6.60 0.260 | 39.40 1.550 | 9.80 0.385 | 26.00 | 81 | 131 | 235 | 265 | 2646540002 |
| 0446164251 | 2 | 6.30 0.250 | 17.90 0.705 | 6.60 0.260 | 32.20 1.270 | 9.20 0.362 | 31.00 | 81 | 134 | 245 | 273 | 2646540002 |
| 0446167281 | 1 | 9.85 0.388 | 23.70 0.933 | 10.15 0.400 | 39.40 1.550 | 11.70 0.460 | 33.00 | 66 | 105 | 190 | 275 | 2646626402 |
| 0446167251 | 2 | 9.85 0.388 | 22.10 0.870 | 10.15 0.400 | 32.30 1.272 | 11.00 0.433 | 42.00 | 72 | 116 | 202 | 247 | 2646626402 |
| 0446164181 | 1 | 12.70 0.500 | 31.00 1.220 | 13.05 0.514 | 39.40 1.550 | 15.25 0.600 | 61.00 | 73 | 115 | 205 | 275 | 2646102002 |
| 0446164151 | 2 | 12.70 0.500 | 29.00 1.142 | 13.05 0.514 | 32.50 1.280 | 14.80 0.583 | 84.00 | 84 | 127 | 225 | 270 | 2646102002 |
| 0446176451 | 1 | 18.00 0.709 | 38.60 1.520 | 18.35 0.722 | 47.50 1.870 | 19.15 0.755 | 161.00 | 85 | 137 | 330 | 360 | - |

Fair-Rite Products Corp. PO Box 288, One Commercial Row, Wallkill, NY 12589-0288

Round Cable Snap-Its



Quick Link: www.fair-rite.com/rcs

Listed by frequency range and in ascending order of cable diameter.

Broadband Frequencies 25-300 MHz (Economical 46 material)

| Part Number | Fig. | Max. Cable Diameter | A | B | C | D | Wt. (g) | Impedance (Ω) | | | | Solid Equivalent |
|-------------|------|---------------------|----------------|----------------|----------------|----------------|---------|------------------------|--------|----------------------|---------|------------------|
| | | | | | | | | 10 MHz | 25 MHz | 100 MHz ⁺ | 250 MHz | |
| 0446173551 | 2 | 18.50 0.728 | 29.20 1.150 | 18.80 0.740 | 42.00 1.650 | 14.70 0.579 | 78.00 | 48 | 85 | 176 | 300 | - |

Higher Frequencies 200-1000 MHz (61 material)

| Part Number | Fig. | Max. Cable Diameter | A | B | C | D | Wt. (g) | Impedance (Ω) | | | | Solid Equivalent |
|-------------|------|---------------------|----------------|----------------|----------------|----------------|---------|------------------------|----------------------|----------------------|----------|------------------|
| | | | | | | | | 100 MHz | 250 MHz ⁺ | 500 MHz ⁺ | 1000 MHz | |
| 0461178181 | 1 | 4.10 0.161 | 11.80 0.465 | 4.30 0.169 | 23.20 0.913 | 5.60 0.221 | 4.20 | 115 | 165 | 215 | 300 | - |
| 0461164951 | 1 | 4.90 0.193 | 17.30 0.680 | 5.10 0.201 | 38.20 1.420 | 8.40 0.331 | 17.00 | 215 | 325 | 385 | 332 | 2661480002 |
| 0461164281 | 1 | 6.30 0.250 | 20.00 0.788 | 6.60 0.260 | 39.40 1.550 | 9.80 0.385 | 26.00 | 230 | 355 | 425 | 420 | 2661540002 |
| 0461178281 | 1 | 8.70 0.343 | 21.50 0.846 | 9.00 0.354 | 39.40 1.550 | 10.55 0.415 | 24.00 | 180 | 285 | 380 | 430 | 2661665702 |
| 0461167281 | 1 | 9.85 0.388 | 23.70 0.933 | 10.15 0.400 | 39.40 1.550 | 11.70 0.460 | 33.00 | 175 | 275 | 375 | 400 | 2661626402 |
| 0461164181 | 1 | 12.70 0.500 | 31.00 1.220 | 13.05 0.514 | 39.40 1.550 | 15.25 0.600 | 61.00 | 205 | 320 | 435 | 257 | 2661102002 |
| 0461176451 | 1 | 18.00 0.709 | 38.60 1.520 | 18.35 0.722 | 47.50 1.870 | 19.15 0.755 | 161.00 | 360 | 480 | 350 | 110 | - |

Fair-Rite Products Corp. PO Box 288, One Commercial Row, Wallkill, NY 12589-0288

Phone: (888) FAIR RITE / (845) 895-2055 • Fax: (888) FERRITE / (845) 895-2629 • Web: www.fair-rite.com
 (888) 324-7748 (888) 337-7483 E-mail: ferrites@fair-rite.com

Flat Cable EMI Suppression Cores



Quick Link: www.fair-rite.com/fcc

Listed by frequency range and in ascending order of cable width.

Flat cable suppression core can accommodate multi-conductors flat cables, in widths from 12.7 mm (0.500") up to 77 mm (3.0"). These flat cable cores are available in two ferrite material grades to reduce conducted EMI from 1 MHz to hundreds of MHz.

- Flat cable suppression cores, split or single cores, are controlled for impedances only. Minimum impedance values are specified for the + marked frequencies. The minimum impedance is typically the listed impedance less 20%.
- Centered, single turn impedance tests for the 31 and 43 material parts are performed on the 4193A Vector Impedance Analyzer. **All tests are made with the shortest practical wire length.**
- Performance curves for these suppression components are on our web site.
- Assembly clips are available for most of the split flat cable cores. See section "Flat Cable Cores Assembly clips".
- Our "Expanded Cable & Suppressor Kit" (part number 0199000005) contains a selection of these flat cable cores and clips.
- Flat Cable Cores are available in selected sizes in the "Flex Circuit & Ribbon Cable Core Kit" (part number 0199000038).
- Explanation of Part Numbers: Digits 1&2 = product class and 3&4 = material grade.

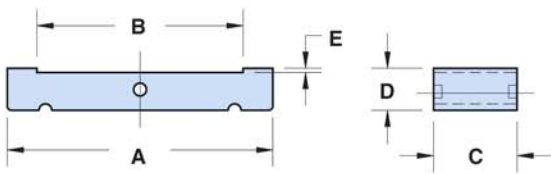

Figure 1

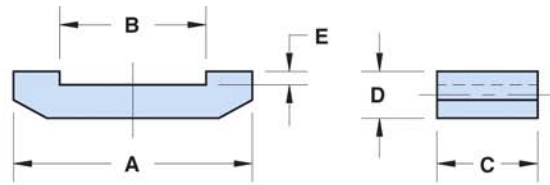

Figure 2

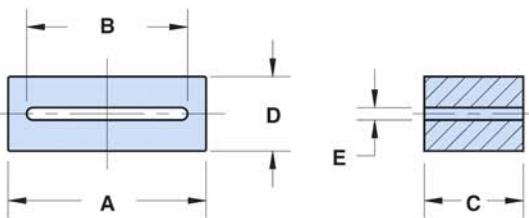

Figure 3

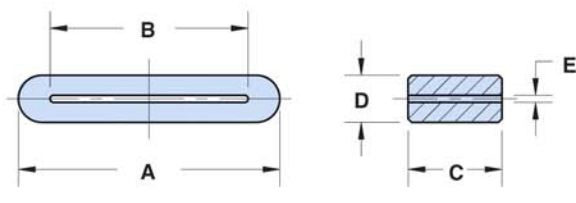

Figure 4

Fair-Rite Products Corp. PO Box 288, One Commercial Row, Walkill, NY 12589-0288

Phone: (888) FAIR RITE / (845) 895-2055 • Fax: (888) FERRITE / (845) 895-2629 • Web: www.fair-rite.com
(888) 324-7748 (888) 337-7483 E -mail: ferrites@fair-rite.com

Flat Cable EMI Suppression Cores



Quick Link: www.fair-rite.com/fcc

Listed by frequency range and in ascending order of cable width.

Legend

Dimensions (Top numbers are in millimeters, bottom numbers are in nominal inches.)

* Test frequency

Lower & Broadband Frequencies 1-300 MHz (31 material)

| Part Number | Fig. | Max. Cable Dimensions | A | B | C | D | E | Wt. (g) | Impedance (Ω) | | | | | |
|-------------|------|-------------------------------|----------------------|----------------------|----------------------|----------------------|---------------------|---------|---------------|-------|---------------------|---------------------|----------------------|---------|
| | | | | | | | | | 1 MHz | 5 MHz | 10 MHz ⁺ | 25 MHz ⁺ | 100 MHz ⁺ | 250 MHz |
| 2631163851 | 3 | 25.90 x 1.50 1.020 x 0.060 | 38.10 ±1.00 1.500 | 26.65 ±0.75 1.050 | 25.40 ±0.75 1.000 | 12.05 ±0.40 0.475 | 1.90 ±0.40 0.075 | 51.00 | 20 | 52 | 68 | 112 | 240 | 440 |
| 2631164051 | 1 | 64.00 x 1.30 2.520 x 0.050 | 76.20 ±1.50 3.000 | 65.30 ±1.30 2.570 | 28.60 ±0.80 1.125 | 6.35 ±0.25 0.250 | 0.85 ±0.20 0.033 | 60.00 | 11 | 34 | 52 | 105 | 310 | 440 |

Broadband Frequencies 25-300 MHz (43 material)

| Part Number | Fig. | Max. Cable Dimensions | A | B | C | D | E | Wt. (g) | Impedance (Ω) | | | |
|-------------|------|--------------------------------|----------------------|----------------------|----------------------|----------------------|---------------------|---------|---------------|---------------------|----------------------|---------|
| | | | | | | | | | 10 MHz | 25 MHz ⁺ | 100 MHz ⁺ | 250 MHz |
| 2643180251 | 3 | 8.90 x 0.60 0.350 x 0.024 | 13.70 ±0.40 0.539 | 9.20 ±0.30 0.362 | 18.00 ±0.40 0.709 | 5.30 ±0.30 0.209 | 0.80 ±0.20 0.031 | 5.60 | 55 | 80 | 130 | 225 |
| 2643180851 | 1 | 9.50 x 0.80 0.375 x 0.031 | 12.80 ±0.40 0.504 | 9.80 ±0.25 0.386 | 12.00 ±0.40 0.472 | 2.10 ±0.20 0.083 | 0.50 ±0.1 0.020 | 1.30 | 22 | 40 | 70 | 100 |
| 2643173851 | 1 | 12.30 x 1.00 0.484 x 0.039 | 16.50 ±0.25 0.650 | 12.50 ±0.20 0.492 | 10.25 ±0.25 0.404 | 2.00 ±0.15 0.079 | 0.63 ±0.13 0.025 | 1.20 | 15 | 28 | 58 | 93 |
| 2643170251 | 2 | 12.20 x 2.30 0.480 x 0.091 | 22.75 ±0.65 0.895 | 12.70 ±0.50 0.500 | 12.70 ±0.50 0.500 | 3.30 ±0.25 0.125 | 1.15 ±0.25 0.050 | 3.50 | 20 | 35 | 70 | 135 |
| 2643178351 | 4 | 13.10 x 1.35 0.516 x 0.053 | 18.50 ±0.40 0.728 | 13.50 ±0.40 0.531 | 12.00 ±0.30 0.472 | 6.60 ±0.25 0.260 | 1.60 ±0.25 0.063 | 5.90 | 31 | 48 | 82 | 140 |
| 2643169552 | 3 | 13.95 x 0.75 0.549 x 0.030 | 19.95 ±0.40 0.785 | 14.20 ±0.25 0.560 | 10.15 ±0.50 0.400 | 6.35 ±0.25 0.250 | 0.90 ±0.15 0.035 | 5.70 | 25 | 40 | 90 | 160 |
| 2643168751 | 3 | 17.30 x 2.30 0.681 x 0.091 | 25.40 ±0.75 1.000 | 17.80 ±0.50 0.700 | 12.70 ±0.40 0.500 | 10.15 ±0.25 0.400 | 2.55 ±0.25 0.100 | 13.00 | 31 | 50 | 95 | 200 |
| 2643173351 | 4 | 19.60 x 0.50 0.772 x 0.020 | 24.50 ±0.40 0.965 | 20.00 ±0.40 0.787 | 12.00 ±0.30 0.472 | 5.00 ±0.25 0.197 | 0.75 ±0.25 0.030 | 6.60 | 23 | 39 | 88 | 157 |
| 2643180351 | 3 | 20.30 x 0.70 0.799 x 0.027 | 25.00 ±0.80 0.984 | 21.00 ±0.70 0.827 | 12.00 ±0.30 0.472 | 5.00 ±0.30 0.197 | 0.80 ±0.10 0.031 | 6.20 | 21 | 36 | 80 | 125 |
| 2643178651 | 4 | 21.10 x 1.35 0.831 x 0.053 | 26.50 ±0.40 1.043 | 21.50 ±0.40 0.846 | 6.00 ±0.30 0.236 | 6.60 ±0.25 0.260 | 1.60 ±0.25 0.063 | 4.10 | 13 | 22 | 50 | 95 |
| 2643178551 | 4 | 21.10 x 1.35 0.831 x 0.053 | 26.50 ±0.40 1.043 | 21.50 ±0.40 0.846 | 12.00 ±0.30 0.472 | 6.60 ±0.25 0.260 | 1.60 ±0.25 0.063 | 8.20 | 24 | 38 | 82 | 155 |
| 2643169351 | 3 | 27.00 x 1.10 1.063 x 0.043 | 33.65 ±0.75 1.325 | 27.50 ±0.50 1.083 | 13.20 ±0.50 0.520 | 6.70 ±0.40 0.264 | 1.35 ±0.25 0.053 | 12.00 | 22 | 37 | 89 | 170 |
| 2643168651 | 2 | 25.40 x 12.20 1.000 x 0.480 | 38.85 ±0.75 1.530 | 26.15 ±0.75 1.030 | 28.60 ±0.70 1.125 | 13.00 ±0.30 0.512 | 6.35 ±0.25 0.255 | 45.00 | 57 | 100 | 188 | 295 |
| 2643164551 | 3 | 25.90 x 1.50 1.020 x 0.059 | 38.10 ±1.00 1.500 | 26.65 ±0.75 1.050 | 12.30 ±0.40 0.485 | 12.05 ±0.40 0.475 | 1.90 ±0.40 0.075 | 25.00 | 33 | 53 | 105 | 215 |
| 2643171051 | 1 | 25.90 x 1.30 1.020 x 0.051 | 38.10 ±1.00 1.500 | 26.65 ±0.75 1.050 | 12.70 ±0.40 0.500 | 6.35 ±0.25 0.250 | 0.85 ±0.20 0.033 | 14.00 | 32 | 53 | 112 | 235 |
| 2643166851 | 1 | 25.90 x 1.30 1.020 x 0.051 | 38.10 ±1.00 1.500 | 26.65 ±0.75 1.050 | 25.40 ±0.75 1.000 | 6.35 ±0.25 0.250 | 0.85 ±0.20 0.033 | 27.00 | 66 | 115 | 235 | 410 |
| 2643163851 | 3 | 25.90 x 1.50 1.020 x 0.059 | 38.10 ±1.00 1.500 | 26.65 ±0.75 1.050 | 25.40 ±0.75 1.000 | 12.05 ±0.40 0.475 | 1.90 ±0.40 0.075 | 51.00 | 64 | 105 | 220 | 385 |
| 2643178751 | 4 | 26.10 x 1.35 1.028 x 0.053 | 31.50 ±0.40 1.240 | 26.50 ±0.40 1.043 | 12.00 ±0.30 0.472 | 6.60 ±0.25 0.260 | 1.60 ±0.25 0.063 | 9.70 | 22 | 37 | 85 | 157 |
| 2643180451 | 4 | 26.30 x 0.70 1.035 x 0.027 | 31.00 ±1.00 1.220 | 27.00 ±0.70 1.063 | 6.00 ±0.30 0.236 | 5.00 ±0.30 0.197 | 0.80 ±0.10 0.031 | 3.90 | 10.5 | 20 | 45 | 70 |
| 2643172551 | 4 | 26.50 x 1.25 1.043 x 0.049 | 33.50 ±0.65 1.319 | 27.00 ±0.50 1.063 | 8.00 ±0.40 0.315 | 6.50 ±0.25 0.256 | 1.25 ±0.70 0.063 | 6.80 | 12 | 22 | 58 | 106 |

Fair-Rite Products Corp. PO Box 288, One Commercial Row, Wallkill, NY 12589-0288

Phone: (888) FAIR RITE / (845) 895-2055 • Fax: (888) FERRITE / (845) 895-2629 • Web: www.fair-rite.com
 (888) 324-7748 (888) 337-7483 E -mail: ferrites@fair-rite.com

Flat Cable EMI Suppression Cores



Quick Link: www.fair-rite.com/fcc

Listed by frequency range and in ascending order of cable width.

Broadband Frequencies 25-300 MHz (43 material)

| Part Number | Fig. | Max. Cable Dimensions | A | B | C | D | E | Wt. (g) | Impedance (Ω) | | | |
|-------------|------|-------------------------------|----------------------|----------------------|----------------------|----------------------|---------------------|---------|------------------------|---------------------|----------------------|---------|
| | | | | | | | | | 10 MHz | 25 MHz ⁺ | 100 MHz ⁺ | 250 MHz |
| 2643166451 | 1 | 26.95 x 6.10 1.061 x 0.240 | 38.35 ±1.00 1.510 | 27.95 ±1.00 1.100 | 28.60 ±0.70 1.125 | 9.00 ±0.30 0.355 | 3.30 ±0.25 0.130 | 35.00 | 61 | 96 | 185 | 335 |
| 2643168051 | 1 | 32.30 x 6.20 1.272 x 0.244 | 52.90 ±1.00 2.083 | 33.00 ±0.70 1.299 | 31.25 ±1.00 1.230 | 12.50 ±0.40 0.492 | 3.50 ±0.40 0.138 | 84.00 | 81 | 140 | 265 | 400 |
| 2643167551 | 1 | 32.30 x 6.20 1.272 x 0.244 | 52.90 ±1.00 2.083 | 33.00 ±0.70 1.299 | 63.50 ±1.80 2.500 | 12.50 ±0.40 0.492 | 3.50 ±0.40 0.138 | 170.00 | 150 | 270 | 480 | 370 |
| 2643170951 | 1 | 33.70 x 1.30 1.327 x 0.051 | 45.10 ±0.75 1.775 | 34.40 ±0.70 1.355 | 12.70 ±0.40 0.500 | 6.35 ±0.25 0.250 | 0.85 ±0.20 0.033 | 16.00 | 25 | 50 | 115 | 240 |
| 2643166551 | 3 | 33.70 x 1.20 1.327 x 0.047 | 45.10 ±0.75 1.775 | 34.40 ±0.70 1.355 | 28.60 ±0.70 1.125 | 12.45 ±0.40 0.490 | 1.50 ±0.30 0.060 | 71.00 | 67 | 115 | 300 | 415 |
| 2643166651 | 1 | 33.70 x 1.30 1.327 x 0.051 | 45.10 ±0.75 1.775 | 34.40 ±0.70 1.355 | 28.60 ±0.70 1.125 | 6.35 ±0.25 0.250 | 0.85 ±0.20 0.033 | 36.00 | 60 | 110 | 290 | 435 |
| 2643180551 | 4 | 34.10 x 1.05 1.342 x 0.041 | 40.00 ±1.00 1.575 | 34.80 ±0.70 1.370 | 18.00 ±0.40 0.709 | 6.50 ±0.30 0.256 | 1.30 ±0.25 0.051 | 18.00 | 25 | 44 | 110 | 170 |
| 2643180651 | 4 | 39.00 x 1.20 1.535 x 0.047 | 45.20 ±1.00 1.780 | 40.00 ±1.00 1.575 | 12.00 ±0.40 0.472 | 6.50 ±0.30 0.256 | 1.50 ±0.30 0.059 | 13.00 | 17 | 23 | 33 | 160 |
| 2643180751 | 4 | 51.00 x 1.10 2.008 x 0.043 | 57.60 ±1.00 2.268 | 52.00 ±1.00 2.047 | 12.00 ±0.40 0.472 | 6.50 ±0.30 0.256 | 1.40 ±0.30 0.055 | 17.00 | 20 | 33 | 76 | 165 |
| 2643168251 | 1 | 51.00 x 1.30 2.008 x 0.051 | 63.50 ±1.30 2.500 | 52.10 ±1.10 2.050 | 12.70 ±0.40 0.500 | 6.35 ±0.25 0.250 | 0.85 ±0.20 0.033 | 22.00 | 22 | 50 | 125 | 255 |
| 2643163951 | 1 | 51.00 x 1.30 2.008 x 0.051 | 63.50 ±1.30 2.500 | 52.10 ±1.10 2.050 | 28.60 ±0.80 1.125 | 6.35 ±0.25 0.250 | 0.85 ±0.20 0.033 | 50.00 | 56 | 100 | 290 | 400 |
| 2643167751 | 1 | 64.00 x 1.30 2.520 x 0.051 | 76.20 ±1.50 3.000 | 65.30 ±1.30 2.570 | 12.70 ±0.40 0.500 | 6.35 ±0.25 0.250 | 0.85 ±0.20 0.033 | 27.00 | 22 | 45 | 115 | 240 |
| 2643164051 | 1 | 64.00 x 1.30 2.520 x 0.051 | 76.20 ±1.50 3.000 | 65.30 ±1.30 2.570 | 28.60 ±0.80 1.125 | 6.35 ±0.25 0.250 | 0.85 ±0.20 0.033 | 60.00 | 48 | 100 | 290 | 420 |
| 2643168351 | 1 | 76.70 x 1.30 3.020 x 0.051 | 88.90 ±1.80 3.500 | 78.20 ±1.50 3.080 | 28.60 ±0.80 1.125 | 6.50 ±0.35 0.256 | 0.95 ±0.30 0.037 | 70.00 | 45 | 100 | 280 | 440 |

Fair-Rite Products Corp. PO Box 288, One Commercial Row, Wallkill, NY 12589-0288

Flat Cable Cores Assembly Clips



Quick Link: www.fair-rite.com/fca

Fair-Rite offers several clips to accommodate the assembly of the split flat cable suppression cores.

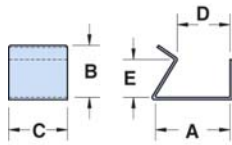

Figure 1

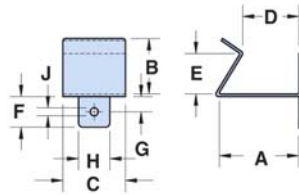

Figure 2

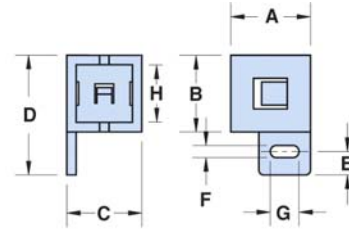

Figure 3

- Figures 1 and 2 are metal clips, made from 0.5 mm (0.020") high carbon steel with a zinc electroplate finish.
- Figure 3 clips are a polypropylene material RoHS compliant, with a flammability rating of UL 94 V-0.

Legend

Dimensions (Top numbers are in millimeters, bottom numbers are in nominal inches.)

Clips

| Part Number | Fig. | A | B | C | D | E | F | G | H | J | Flat Cable Cores |
|-------------|------|----------------|----------------|----------------|----------------|---------------|---------------|---------------|----------------|---------------|--|
| 0199001401 | 1 | 16.10 0.635 | 11.00 0.433 | 12.70 0.500 | 11.40 0.450 | 8.00 0.315 | - | - | - | - | 2631164051 2643163951 2643164051 2643166651 2643166851 2643167751 2643168251 2643168351 2643170951 2643171051 |
| 0199010301 | 2 | 21.20 0.835 | 11.00 0.433 | 12.70 0.500 | 16.50 0.650 | 8.00 0.315 | 7.50 0.295 | 4.00 0.157 | 6.00 0.236 | 3.00 0.118 | 2643166451 |
| 0199016051 | 3 | 16.70 0.657 | 15.90 0.626 | 15.90 0.626 | 24.60 0.969 | 4.40 0.171 | 3.20 0.126 | 6.40 0.252 | 13.10 0.516 | - | 2643167751 2643168251 2643170951 2643171051 |
| 0199016551 | 3 | 16.70 0.657 | 32.20 1.270 | 15.90 0.626 | 40.50 1.590 | 4.40 0.171 | 3.20 0.126 | 6.40 0.252 | 29.50 1.161 | - | 2631164051 2643163951 2643164051 2643166651 2643168351 |

Fair-Rite Products Corp. PO Box 288, One Commercial Row, Wallkill, NY 12589-0288

Phone: (888) FAIR RITE / (845) 895-2055 • Fax: (888) FERRITE / (845) 895-2629 • Web: www.fair-rite.com
(888) 324-7748 (888) 337-7483 E-mail: ferrites@fair-rite.com

Flat Cable Snap-Its



Quick Link: www.fair-rite.com/fcs

Listed by frequency range and in ascending order of Cable width.

Flat cable snap-its for use on multi-conductor flat cables to suppress common-mode conducted EMI from 1MHz to hundreds of MHz. These flat cable snap-its are available in two ferrite materials, 31 and 43. The polypropylene cases are meeting the RoHS restrictions of hazardous substances and have a flammability rating of UL 94 V-0.

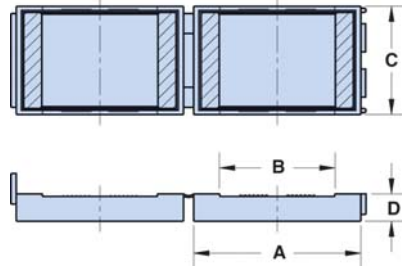

- Flat cable snap-it assemblies are controlled for impedances only. Minimum impedance values are specified for the + marked frequencies. The minimum impedance is typically the listed impedance less 20%.
- Centered, single turn impedance tests on the 31 and 43 material parts are performed on the 4193A Vector Impedance Analyzer. **Cores are tested with the shortest practical wire length.**
- Performance curves for these suppression components are on our web site.
- The “Expanded Cable and Suppressor Kit” (Part number 0199000005) contains several flat cable snap-it assemblies.
- Explanation of Part Numbers: Digits 1&2 = product class and 3&4 = material grade.

Legend

Dimensions (Top numbers are in millimeters, bottom numbers are in nominal inches.)

+ Test frequency

Lower & Broadband Frequencies 1-300 MHz (31 material)

| Part Number | Max. Cable Dimensions | A | B | C | D | Wt. (g) | Impedance (Ω) | | | | | |
|-------------|-------------------------------|----------------|----------------|----------------|---------------|---------|------------------------|-------|---------------------|---------------------|----------------------|---------|
| | | | | | | | 1 MHz | 5 MHz | 10 MHz ⁺ | 25 MHz ⁺ | 100 MHz ⁺ | 250 MHz |
| 0431163951 | 51.00 x 1.30 2.000 x 0.050 | 67.80 2.670 | 52.10 2.050 | 32.30 1.272 | 8.10 0.320 | 110.00 | 13 | 35 | 54 | 105 | 300 | 425 |
| 0431164051 | 64.00 x 1.30 2.520 x 0.050 | 80.80 3.180 | 65.30 2.570 | 32.30 1.272 | 8.10 0.320 | 130.00 | 11 | 34 | 52 | 105 | 310 | 440 |

Broadband Frequencies 25-300 MHz (43 material)

| Part Number | Max. Cable Dimensions | A | B | C | D | Wt. (g) | Impedance (Ω) | | | |
|-------------|-------------------------------|----------------|----------------|----------------|---------------|---------|------------------------|---------------------|----------------------|---------|
| | | | | | | | 10 MHz | 25 MHz ⁺ | 100 MHz ⁺ | 250 MHz |
| 0443166651 | 33.70 x 1.30 1.325 x 0.050 | 49.50 1.950 | 34.40 1.350 | 32.30 1.272 | 8.10 0.320 | 80.00 | 60 | 110 | 290 | 435 |
| 0443163951 | 51.00 x 1.30 2.000 x 0.050 | 67.80 2.670 | 52.10 2.050 | 32.30 1.272 | 8.10 0.320 | 110.00 | 56 | 100 | 290 | 400 |
| 0443164051 | 64.00 x 1.30 2.520 x 0.050 | 80.80 3.180 | 65.30 2.570 | 32.30 1.272 | 8.10 0.320 | 130.00 | 48 | 100 | 290 | 420 |

Fair-Rite Products Corp. PO Box 288, One Commercial Row, Wallkill, NY 12589-0288

Connector EMI Suppression Plates



Quick Link: www.fair-rite.com/cp

To provide suppression of conducted EMI at critical interfaces Fair-Rite has available a line of suppression plates that can be used with many types of connectors. All connector plates are supplied in the NiZn 44 grade ideally suited for this application because of its high impedance along with a high resistivity.

- Connector plates are controlled for impedances only. Minimum impedance values are specified for the + marked frequencies. The minimum impedance is typically the listed typical impedance less 20%. Single turn impedance tests are performed on the 4193A Vector Impedance Analyzer, **using the shortest practical wire length.**
- Performance curves for these suppression components are on our web site.
- The “C” dimension can be modified to suit specific applications.
- For any connector EMI suppression plate requirement not listed here, feel free to contact our customer service group for availability and pricing.
- Explanation of Part Numbers: Digit 1&2 = product class and 3&4 = the 44 material grade.

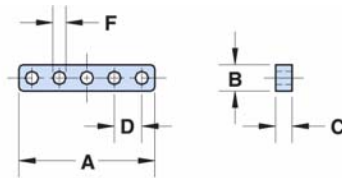

Figure 1

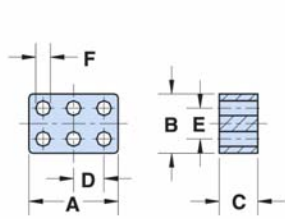

Figure 2

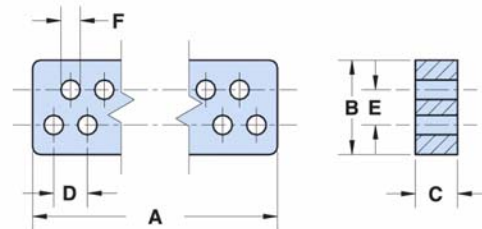

Figure 3

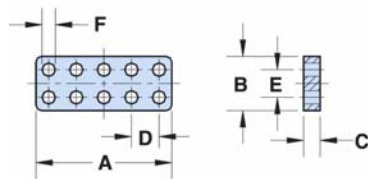

Figure 4

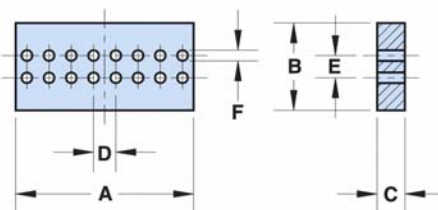

Figure 5

Fair-Rite Products Corp. PO Box 288, One Commercial Row, Wallkill, NY 12589-0288

Phone: (888) FAIR RITE / (845) 895-2055 • Fax: (888) FERRITE / (845) 895-2629 • Web: www.fair-rite.com
(888) 324-7748 (888) 337-7483 E -mail: ferrites@fair-rite.com

Connector EMI Suppression Plates



Quick Link: www.fair-rite.com/cp

Legend

Dimensions (Top numbers are in millimeters, bottom numbers are in nominal inches.)

+ Test frequency

Connector Plates

| Part Number | Fig. | Holes | Rows | A | B | C | D | E | F | Wt. (g) | Impedance (Ω) | |
|-------------|------|-------|------|----------------------|-----------------------|---------------------|---------------------|---------------------|---------------------|---------|---------------------|----------------------|
| | | | | | | | | | | | 25 MHz ⁺ | 100 MHz ⁺ |
| 2644246701 | 1 | 5 | 1 | 12.52 ±0.13 0.493 | 2.54 Max 0.100 Max | 1.52 ±0.13 0.060 | 2.54 ±0.13 0.100 | - | 1.22 ±0.07 0.048 | 0.18 | 13 | 28 |
| 2644246201 | 2 | 6 | 2 | 5.86 ±0.10 0.231 | 3.86 ±0.10 0.152 | 1.52 ±0.13 0.060 | 2.00 ±0.08 0.079 | 2.00 ±0.08 0.079 | 0.82 ±0.10 0.034 | 0.14 | 14 | 28 |
| 2644245701 | 2 | 6 | 2 | 7.44 ±0.10 0.293 | 4.90 ±0.10 0.193 | 1.52 ±0.13 0.060 | 2.54 ±0.13 0.100 | 2.54 ±0.10 0.100 | 1.22 ±0.07 0.048 | 0.22 | 13 | 28 |
| 2644236101 | 3 | 9 | 2 | 14.40 ±0.15 0.567 | 7.75 -0.25 0.300 | 3.43 ±0.13 0.135 | 2.75 ±0.13 0.108 | 2.85 ±0.13 0.112 | 1.60 ±0.08 0.062 | 1.60 | 30 | 51 |
| 2644236401 | 3 | 9 | 2 | 14.40 ±0.15 0.567 | 7.75 -0.25 0.300 | 6.86 ±0.13 0.270 | 2.75 ±0.13 0.108 | 2.85 ±0.13 0.112 | 1.60 ±0.08 0.062 | 3.20 | 56 | 91 |
| 2644247001 | 4 | 10 | 2 | 12.52 ±0.13 0.493 | 4.94 ±0.14 0.194 | 1.52 ±0.13 0.060 | 2.54 ±0.13 0.100 | 2.54 ±0.10 0.100 | 1.22 ±0.07 0.048 | 0.37 | 13 | 28 |
| 2644247101 | 4 | 10 | 2 | 12.52 ±0.13 0.493 | 4.94 ±0.14 0.194 | 3.05 ±0.13 0.120 | 2.54 ±0.13 0.100 | 2.54 ±0.10 0.100 | 1.22 ±0.07 0.048 | 0.74 | 23 | 40 |
| 2644236301 | 3 | 15 | 2 | 22.55 ±0.25 0.888 | 7.75 -0.25 0.300 | 3.43 ±0.13 0.135 | 2.75 ±0.13 0.108 | 2.85 ±0.13 0.112 | 1.60 ±0.08 0.062 | 2.40 | 30 | 51 |
| 2644236501 | 3 | 15 | 2 | 22.55 ±0.25 0.888 | 7.75 -0.25 0.300 | 6.86 ±0.13 0.270 | 2.75 ±0.13 0.108 | 2.85 ±0.13 0.112 | 1.60 ±0.08 0.062 | 4.90 | 56 | 91 |
| 2644373941 | 5 | 16 | 2 | 21.60 ±0.25 0.850 | 11.65 -0.40 0.451 | 1.52 ±0.13 0.060 | 2.54 ±0.13 0.100 | 7.62 ±0.15 0.300 | 1.00 ±0.15 0.042 | 2.90 | 19 | 36 |
| 2644373841 | 5 | 16 | 2 | 20.30 ±0.25 0.800 | 10.15 -0.40 0.392 | 3.18 ±0.13 0.125 | 2.54 ±0.13 0.100 | 2.54 ±0.10 0.100 | 1.22 ±0.07 0.048 | 2.80 | 30 | 51 |
| 2644236001 | 3 | 25 | 2 | 36.30 ±0.40 1.430 | 7.75 -0.25 0.300 | 3.43 ±0.13 0.135 | 2.75 ±0.13 0.108 | 2.85 ±0.13 0.112 | 1.60 ±0.08 0.062 | 3.60 | 30 | 51 |
| 2644236601 | 3 | 25 | 2 | 36.30 ±0.40 1.430 | 7.75 -0.25 0.300 | 6.86 ±0.13 0.270 | 2.75 ±0.13 0.108 | 2.85 ±0.13 0.112 | 1.60 ±0.08 0.062 | 7.20 | 56 | 91 |

Fair-Rite Products Corp. PO Box 288, One Commercial Row, Wallkill, NY 12589-0288

Quick Link: www.fair-rite.com/msc

Fair-Rite has tooled several special core geometries in the 43 & 77 material for suppression of conducted EMI.

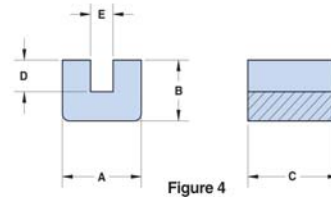
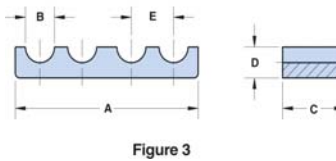
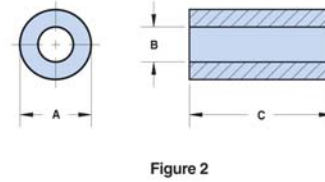
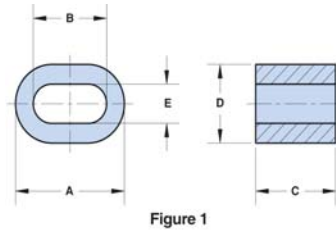

- These suppression cores are controlled for impedance only. The minimum impedance is typically the listed impedance less 20%. Single turns tests are performed on the 4193A Vector Impedance Analyzer **with the shortest practical wire length**.
- Performance curves for these suppression components are on our web site.
- For any non-catalog suppression core design feel free to contact our customer service or application group for feasibility and availability.
- The “C” dimension, the core length, can be modified to suit specific applications.
- Explanation of Part Numbers: Digits 1&2 = product class and 3&4 = the material grade.

Legend

Dimensions (Top numbers are in millimeters, bottom numbers are in nominal inches.)

* Test frequency

Parts for Fig's 3 & 4 tested in pairs

Broadband Frequencies 25-300 MHz (43 material)

| Part Number | Fig. | A | B | C | D | E | Wt. (g) | Impedance (Ω) | | | |
|-------------|------|----------------------|----------------------|----------------------|----------------------|----------------------|---------|---------------|---------------------|----------------------|---------|
| | | | | | | | | 10 MHz | 25 MHz ⁺ | 100 MHz ⁺ | 250 MHz |
| 2643167851 | 1 | 38.85 ±0.75 1.530 | 26.15 ±0.75 1.030 | 28.60 ±0.70 1.125 | 26.00 ±0.60 1.025 | 12.95 ±0.25 0.510 | 85.00 | 60 | 94 | 169 | 250 |
| 2643165151 | 3 | 82.60 ±1.60 3.250 | 13.10 ±0.30 0.516 | 28.00 ±0.70 1.100 | 12.95 ±0.25 0.510 | 19.05 ±0.40 0.750 | 109.00 | 100 | 163 | 280 | 340 |
| 2643175451 | 4 | 17.80 ±0.40 0.700 | 12.70 ±0.50 0.500 | 20.32 ±0.50 0.800 | 6.60 ±0.25 0.260 | 5.08 ±0.25 0.200 | 19.00 | 75 | 119 | 180 | 270 |

Lower Frequencies < 50 MHz (77 material)

| Part Number | Fig. | A | B | C | Wt. (g) | Impedance (Ω) | | |
|-------------|------|----------------------|----------------------|----------------------|---------|---------------|---------------------|---------------------|
| | | | | | | 1 MHz | 10 MHz ⁺ | 25 MHz ⁺ |
| 2677006302 | 2 | 9.50 ±0.25 0.375 | 4.75 ±0.30 0.193 | 10.40 ±0.25 0.410 | 2.20 | 25 | 40 | 33 |
| 2677102402 | 2 | 25.90 ±0.75 1.020 | 12.80 ±0.25 0.505 | 21.30 ±0.50 0.840 | 41.00 | 52 | 25 | 23 |

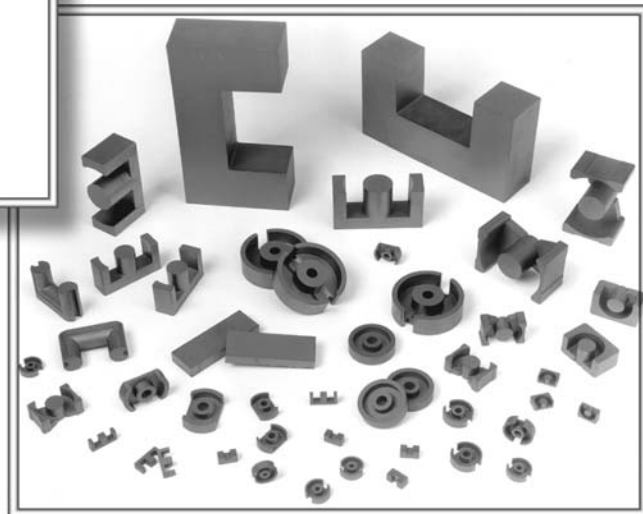
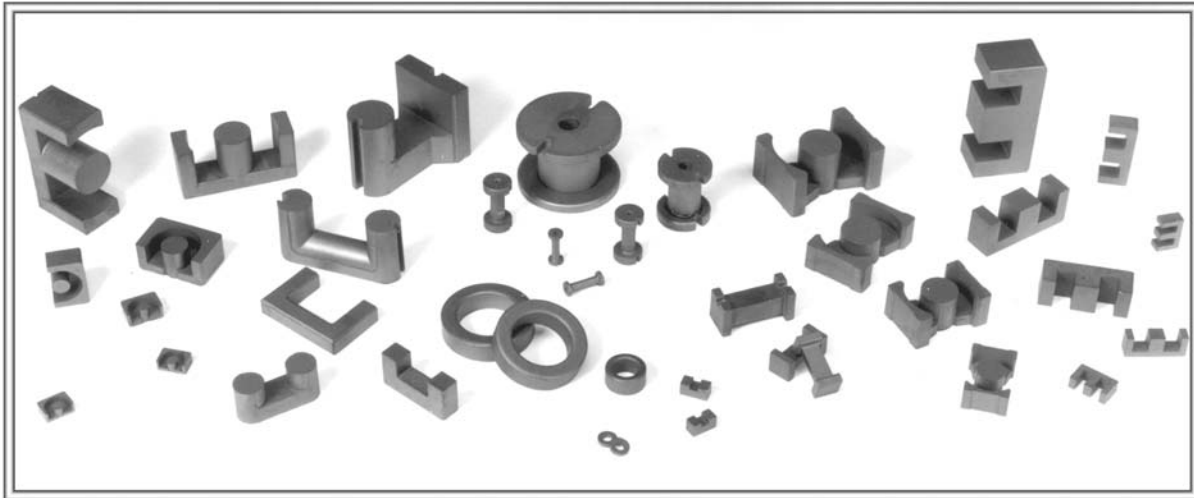

Quick Link: www.fair-rite.com/rod

Pressed Fair-Rite rods are used extensively in high-energy storage designs. These rods can also be used for inductive components that require temperature stability or have to accommodate large dc bias requirements.

- The “A” dimension can be centerless ground to tighter tolerances.
- Figure 2 rods have a 0.6 mm (0.024”) maximum chamfer on the end faces.
- For frequency tuned rod designs see section “Antenna/RFID Rods”.
- For any rod requirement not listed here, feel free to contact our customer service group for availability and pricing.
- Explanation of Part Numbers: Digits 1&2 = product class, 3&4 = material grade.

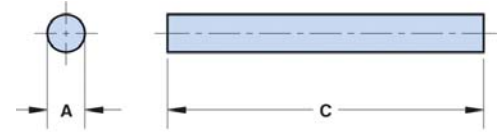

Figure 1

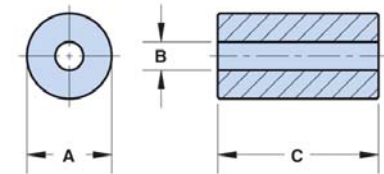

Figure 2

Legend

Dimensions (Top numbers are in millimeters, bottom numbers are in nominal inches.)

Low Permeability, 61($\mu_i=125$) material

| Part Number | Fig. | A | C | Wt. (g) |
|-------------|------|--------------------------|---------------------------|---------|
| 4061272011 | 1 | 6.35 \pm 0.25 0.250 | 19.05 \pm 0.75 0.750 | 2.90 |
| 4061287011 | 1 | 6.35 \pm 0.25 0.250 | 22.10 \pm 0.70 0.870 | 3.40 |
| 4061276011 | 1 | 6.35 \pm 0.25 0.250 | 25.40 \pm 0.70 1.000 | 3.90 |
| 4061266011 | 1 | 6.35 \pm 0.25 0.250 | 38.10 \pm 0.75 1.500 | 5.80 |
| 4061378111 | 1 | 9.50 \pm 0.30 0.374 | 25.40 \pm 0.80 1.000 | 8.60 |
| 4061375411 | 1 | 9.50 \pm 0.30 0.374 | 41.30 \pm 0.80 1.626 | 14.00 |

Low Permeability, High Saturation 52 ($\mu_i=250$) material

| Part Number | Fig. | A | C | Wt. (g) |
|-------------|------|--------------------------|---------------------------|---------|
| 4052077111 | 1 | 2.00 \pm 0.13 0.079 | 15.00 \pm 0.45 0.591 | 0.23 |
| 4052098411 | 1 | 2.50 \pm 0.13 0.098 | 15.00 \pm 0.45 0.591 | 0.36 |
| 4052111011 | 1 | 3.00 \pm 0.13 0.118 | 20.00 \pm 0.60 0.787 | 0.69 |
| 4052155611 | 1 | 4.00 \pm 0.15 0.157 | 25.00 \pm 0.70 0.984 | 1.54 |
| 4052195211 | 1 | 5.00 \pm 0.20 0.197 | 25.00 \pm 0.70 0.984 | 2.40 |
| 4052235211 | 1 | 6.00 \pm 0.25 0.236 | 30.00 \pm 0.75 1.181 | 4.10 |
| 4052251111 | 1 | 6.50 \pm 0.25 0.256 | 30.00 \pm 0.75 1.181 | 4.80 |

Temperature Stable, 33 (μ i=600) material

| Part Number | Fig. | A | C | Wt. (g) |
|-------------|------|---------------------|----------------------|---------|
| 4033129021 | 1 | 3.25 -0.25 0.125 | 12.70 ±0.40 0.500 | 0.50 |
| 4033122011 | 1 | 3.25 -0.25 0.125 | 25.40 ±0.75 1.000 | 0.90 |
| 4033276011 | 1 | 6.35 ±0.25 0.250 | 25.40 ±0.75 1.000 | 3.90 |
| 4033266011 | 1 | 6.35 ±0.25 0.250 | 38.10 ±0.75 1.500 | 5.80 |

Medium Permeability, 77 (μ i=2000) & 78 (μ i=2300) materials

| Part Number | Fig. | A | B | C | Wt. (g) |
|-------------|------|----------------------|---------------------|----------------------|---------|
| 4077122011 | 1 | 3.25 -0.25 0.125 | – | 25.40 ±0.75 1.000 | 1.00 |
| 4077172011 | 1 | 4.60 -0.30 0.175 | – | 22.20 ±0.75 0.875 | 1.70 |
| 4077272011 | 1 | 6.35 ±0.25 0.250 | – | 19.05 ±0.75 0.750 | 2.90 |
| 4077276011 | 1 | 6.35 ±0.25 0.250 | – | 25.40 ±0.75 1.000 | 3.80 |
| 4077292011 | 1 | 6.35 ±0.25 0.250 | – | 28.60 ±0.75 1.125 | 4.40 |
| 4077296011 | 1 | 6.35 ±0.25 0.250 | – | 31.75 ±0.75 1.250 | 4.80 |
| 4077266011 | 1 | 6.35 ±0.25 0.250 | – | 38.10 ±0.75 1.500 | 5.80 |
| 4077312911 | 1 | 8.00 ±0.35 0.315 | – | 38.10 ±0.75 1.500 | 9.20 |
| 4077374711 | 1 | 9.45 ±0.20 0.372 | – | 31.75 ±0.75 1.250 | 11.00 |
| 4078375111 | 1 | 9.45 ±0.20 0.372 | – | 38.10 ±0.75 1.500 | 13.00 |
| 4077375411 | 1 | 9.45 ±0.20 0.372 | – | 41.30 ±0.80 1.625 | 14.00 |
| 4077375211 | 1 | 9.45 ±0.20 0.372 | – | 50.80 ±1.00 2.000 | 17.00 |
| 4078377511 | 1 | 9.50 ±0.25 0.374 | – | 70.00 ±1.50 2.756 | 24.00 |
| 4077485111 | 1 | 12.30 ±0.40 0.485 | – | 31.75 ±0.75 1.250 | 18.00 |
| 4077484611 | 1 | 12.30 ±0.40 0.485 | – | 41.30 ±0.80 1.625 | 27.00 |
| 4277142009 | 2 | 9.00 ±0.30 0.354 | 3.20 ±0.10 0.126 | 13.50 ±0.30 0.532 | 3.60 |
| 4277242409 | 2 | 13.00 ±0.30 0.512 | 3.20 ±0.10 0.126 | 17.50 ±0.40 0.690 | 10.00 |
| 4278282509 | 2 | 17.00 ±0.40 0.670 | 4.20 ±0.15 0.165 | 18.95 ±0.45 0.746 | 19.40 |
| 4277352509 | 2 | 21.00 ±0.50 0.825 | 6.90 ±0.40 0.272 | 18.95 ±0.45 0.746 | 28.00 |
| 4277353509 | 2 | 21.00 ±0.50 0.825 | 6.90 ±0.40 0.272 | 29.00 ±0.60 1.140 | 43.00 |
| 4278453509 | 2 | 27.00 ±0.50 1.063 | 9.00 ±0.30 0.354 | 27.00 ±0.60 1.064 | 66.00 |

Rod Information

Figure 1 shows the rod permeability as a function of the length to diameter ratio for the six materials available in rods.

Figures 3, 4 and 5 illustrate typical temperature behavior of wound rods. Wound rods in 33 and 77 material yield the best temperature stable inductors, see Figure 4. Both show a typical inductance change of < 1% over the -40° to 120°C temperature range. The parts have a L/D ratio of 8.1. Lower ratios will change less. This is shown in detail in Figure 5 for the same 52 material but with the L/D ratio as the parameter. A lower ratio means a lower rod permeability but with improved temperature stability.

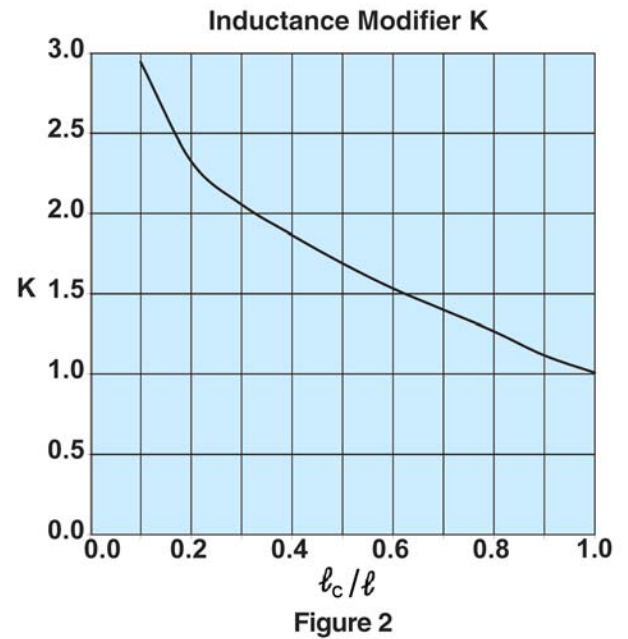
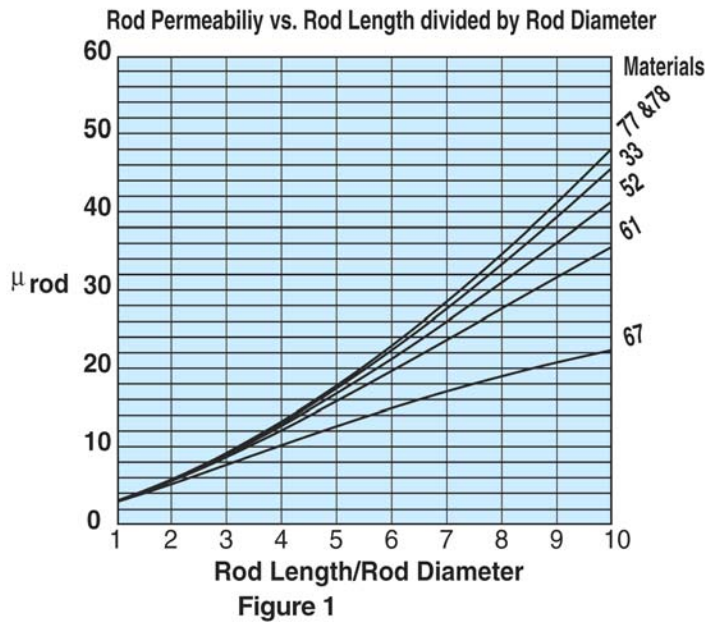

Wound Rod Inductance Calculations

To calculate the inductance of a wound rod the following formula can be used,

$$L = K \mu_0 \mu_{\text{rod}} \frac{N^2 A_e}{l} 10^4 (\mu\text{H})$$

Where: K = Inductance modifier

$$\mu_0 = 4\pi 10^{-7}$$

μ_{rod} = rod permeability found in Figure 1.

N = Number of turns

A_e = Cross sectional area of the rod (cm²)

l = Length of the rod (cm)

l_c = Length of the winding (cm)

Rod Information

The inductance modifier is found in Figure 2. The ratio winding length divided by the rod length will give the inductance modifier. If the rod is totally wound the $K = 1$. Shorter but centered windings will yield higher K values.

Using the rod 3061990871 as an example.

For this rod the length over diameter ratio is 8.33 and for 61 material Figure 1 gives a μ_{rod} of 29. The rod has an $A_e = 0.0707 \text{ cm}^2$ and $l = 2.5 \text{ cm}$.

A winding of 80 turns of 30 AWG wire will yield a fully wound rod, therefore $K = 1$.

Using the formula the calculated inductance is $65.96 \mu\text{H}$.

The same rod but wound with 50 turns of the 30 AWG wire has a winding length of 1.5 cm. The inductance modifier is $1.5/2.5 = 0.60$, which results from Figure 2 in a K value of 1.51.

Again with the formula we calculated an inductance of $38.9 \mu\text{H}$.

The measured values for both windings were 66.95 and $39.50 \mu\text{H}$ respectively.

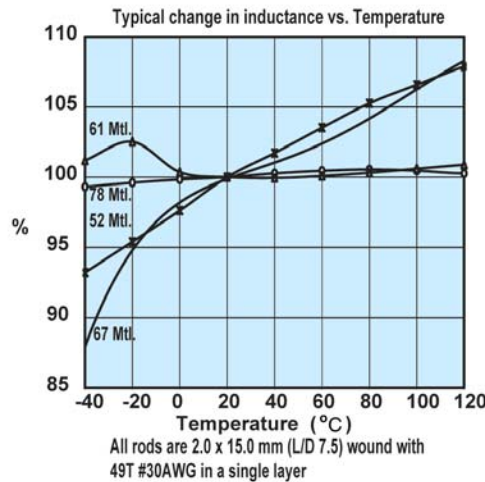

Figure 3

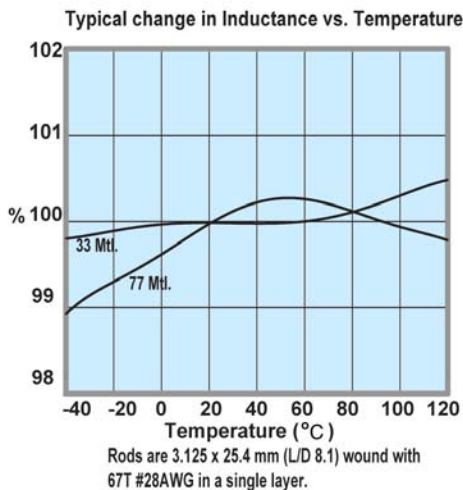

Figure 4

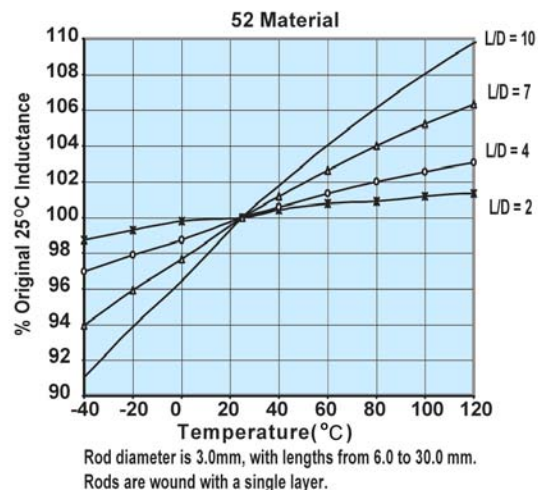
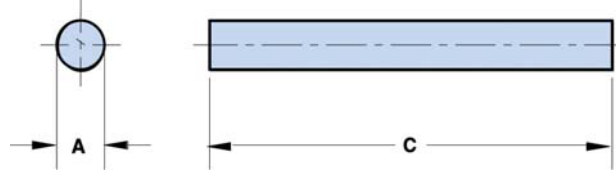

Figure 5

Quick Link: www.fair-rite.com/rfid

These rods are designed for use in antenna and RFID transponder applications. Rods are available in three materials to cover a frequency range from 50 kHz to 25 MHz. Suggested frequency ranges: 78 material < 200 kHz, 61 material 0.2 - 5.0 MHz and 67 material > 5.0 MHz.



- See graphs with temperature information of these rods in the rod information section.
- Rods can be supplied with a Parylene C coating. Parylene coated rods have a “4” as the last digit. Parylene C is RoHS compliant.
- For any rod requirement not listed here, feel free to contact our customer service group for availability and pricing.
- The "Antenna/RFID Kit" (part number 0199000024) contains a selection of these rods.
- Explanation of Part Numbers: Digits 1&2 = product class, 3&4 = material grade, the last digit 1 = uncoated rod and 4 = Parylene coated rod.

Legend

Dimensions (Top numbers are in millimeters, bottom numbers are in nominal inches.)

Low Permeability, 67 ($\mu_i=40$) material

| Part Number | A | C | μ_{ROD} | Wt. (g) | $A_e(\text{cm}^2)$ |
|-------------|----------------------|----------------------|-------------|---------|--------------------|
| 3067990821 | 0.75 ±0.025 0.030 | 7.50 ±0.25 0.295 | 22 | 0.02 | 0.00442 |
| 3067990831 | 1.00 ±0.025 0.039 | 10.00 ±0.30 0.394 | 22 | 0.04 | 0.00785 |
| 3067990841 | 1.50 ±0.025 0.059 | 15.00 ±0.45 0.591 | 22 | 0.13 | 0.0177 |
| 3067990851 | 2.00 ±0.025 0.079 | 15.00 ±0.45 0.591 | 18 | 0.23 | 0.0314 |
| 3067990861 | 2.50 ±0.025 0.098 | 20.00 ±0.60 0.787 | 19 | 0.47 | 0.0491 |
| 3067990871 | 3.00 ±0.04 0.118 | 25.00 ±0.70 0.984 | 20 | 0.85 | 0.0707 |
| 3067990881 | 4.00 ±0.04 0.157 | 30.00 ±0.75 1.181 | 18 | 1.80 | 0.126 |

Low Permeability, 61 ($\mu_i=125$) material

| Part Number | A | C | μ_{ROD} | Wt. (g) | $A_e(\text{cm}^2)$ |
|-------------|---------------------------|---------------------------|-------------|---------|--------------------|
| 3061990821 | 0.75 \pm 0.025 0.030 | 7.50 \pm 0.25 0.295 | 35 | 0.02 | 0.00442 |
| 3061990831 | 1.00 \pm 0.025 0.039 | 10.00 \pm 0.30 0.394 | 35 | 0.04 | 0.00785 |
| 3061990841 | 1.50 \pm 0.025 0.059 | 15.00 \pm 0.45 0.591 | 35 | 0.13 | 0.0177 |
| 3061990851 | 2.00 \pm 0.025 0.079 | 15.00 \pm 0.45 0.591 | 25 | 0.23 | 0.0314 |
| 3061990861 | 2.50 \pm 0.025 0.098 | 20.00 \pm 0.60 0.787 | 27 | 0.47 | 0.0491 |
| 3061990871 | 3.00 \pm 0.04 0.118 | 25.00 \pm 0.70 0.984 | 29 | 0.85 | 0.0707 |
| 3061990881 | 4.00 \pm 0.04 0.157 | 30.00 \pm 0.75 1.181 | 25 | 1.80 | 0.126 |
| 3061990891 | 5.00 \pm 0.04 0.197 | 35.00 \pm 0.80 1.378 | 24 | 3.30 | 0.196 |
| 3061990901 | 6.00 \pm 0.05 0.236 | 40.00 \pm 0.80 1.575 | 22 | 5.40 | 0.283 |
| 3061990911 | 8.00 \pm 0.05 0.315 | 45.00 \pm 0.90 1.772 | 18 | 11.90 | 0.503 |

Medium Permeability, 78 ($\mu_i=2300$) material

| Part Number | A | C | μ_{ROD} | Wt. (g) | $A_e(\text{cm}^2)$ |
|-------------|---------------------------|---------------------------|-------------|---------|--------------------|
| 3078990821 | 0.75 \pm 0.025 0.030 | 7.50 \pm 0.25 0.295 | 48 | 0.02 | 0.00442 |
| 3078990831 | 1.00 \pm 0.025 0.039 | 10.00 \pm 0.30 0.394 | 48 | 0.04 | 0.00785 |
| 3078990841 | 1.50 \pm 0.025 0.059 | 15.00 \pm 0.45 0.591 | 48 | 0.13 | 0.0177 |
| 3078990851 | 2.00 \pm 0.025 0.079 | 15.00 \pm 0.45 0.591 | 31 | 0.23 | 0.0314 |
| 3078990861 | 2.50 \pm 0.025 0.098 | 20.00 \pm 0.60 0.787 | 34 | 0.47 | 0.0491 |
| 3078990871 | 3.00 \pm 0.04 0.118 | 25.00 \pm 0.70 0.984 | 36 | 0.85 | 0.0707 |
| 3078990881 | 4.00 \pm 0.04 0.157 | 30.00 \pm 0.75 1.181 | 31 | 1.80 | 0.126 |
| 3078990891 | 5.00 \pm 0.04 0.197 | 35.00 \pm 0.80 1.378 | 29 | 3.30 | 0.196 |
| 3078990901 | 6.00 \pm 0.05 0.236 | 40.00 \pm 0.80 1.575 | 26 | 5.40 | 0.283 |
| 3078990911 | 8.00 \pm 0.05 0.315 | 45.00 \pm 0.90 1.772 | 20 | 11.90 | 0.503 |

Quick Link: www.fair-rite.com/bob

Bobbins are an economical and well-proven core design for many applications where relatively low but stable inductance values are required.

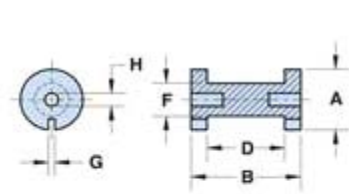

Figure 1

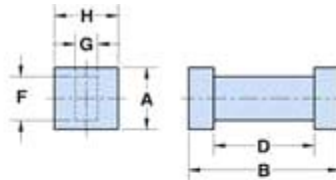

Figure 2

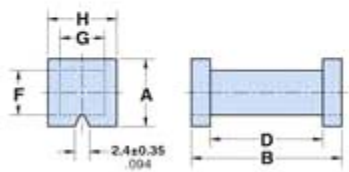

Figure 3

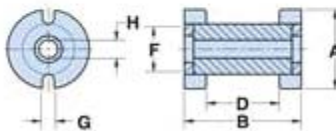

Figure 4

- For higher frequency designs, use small bobbins in 43 material.
- For power applications, bobbins in 77 material are specified for A_L and dc bias limits.
- Bobbins in Figures 2-5 can be supplied with a uniform thermo-set plastic coating which can withstand a minimum breakdown of 500Vrms. This coating will change the dimensions a maximum of 0.5 mm (0.020"). The last digit of the thermo-set plastic coated part is an "8".
- The listed dimensions are for assembled bobbins without thermo-set plastic.
- Bobbins are tested for A_L value at 1kHz < 10 gauss.
- For any bobbin requirement not listed in the catalog, please contact our customer service group for availability and pricing,
- Explanation of Part Numbers: Digits 1&2 = product class, 3&4 = material grade, last digit 8 = coated bobbin.

Quick Link: www.fair-rite.com/bob

Legend: Symbols & Definition

Dimensions (Top numbers are in millimeters, bottom numbers are in nominal inches.)

A_L : Inductance Factor ($\frac{L}{N^2}$), NI: Value of dc Ampere-turns, A_W : Winding Area, N/AWG: Number of Turns / Wire Size for Test Coil

High Frequency Designs

| Row # | Part Number | Fig. | A | B | D | F | G | H | Wt. (g) |
|-------|-------------|------|---------------------|----------------------|----------------------|---------------------|---------------------|---------------------|---------|
| (1) | 9643001165 | 1 | 5.05 -0.15 0.196 | 12.70 ±0.25 0.500 | 10.00 +0.30 0.400 | 2.65 +0.10 0.107 | 0.50 ±0.10 0.020 | 1.00 +0.10 0.042 | 1.30 |
| (2) | 9643001015 | 1 | 9.55 -0.15 0.373 | 19.00 ±0.70 0.750 | 12.70 ±0.15 0.500 | 4.65 +0.20 0.187 | 1.00 +0.25 0.045 | 1.03 +0.10 0.043 | 6.70 |
| (3) | 9843000104 | 2 | 8.05 ±0.20 0.317 | 19.00 ±0.40 0.750 | 12.70 ±0.25 0.500 | 5.55 +0.25 0.225 | 2.70 +0.25 0.111 | 8.05 ±0.20 0.317 | 3.00 |

Table Continued ...

| Row # | Part Number | A_L (nH) | A_L min. @ NI(At) | N/AWG | A_W (cm ²) |
|-------|-------------|------------|---------------------|-------|--------------------------|
| (1) | 9643001165 | 17.5 ±10% | - | 30/24 | 0.12 |
| (2) | 9643001015 | 38.0 ±10% | - | 75/24 | 0.30 |
| (3) | 9843000104 | 38.0 ±10% | - | 50/28 | 0.33 |

Power Applications

| Row # | Part Number | Fig. | A | B | D | F | G | H | Wt. (g) |
|-------|-------------|------|----------------------|----------------------|----------------------|----------------------|---------------------|----------------------|---------|
| (4) | 9677001165 | 1 | 5.05 -0.15 0.196 | 12.70 ±0.25 0.500 | 10.00 +0.30 0.400 | 2.65 +0.10 0.107 | 0.50 ±0.10 0.020 | 1.00 +0.10 0.042 | 1.30 |
| (5) | 9677001015 | 1 | 9.55 -0.15 0.373 | 19.00 ±0.70 0.750 | 12.70 ±0.15 0.500 | 4.65 +0.20 0.187 | 1.00 +0.25 0.045 | 1.03 +0.10 0.043 | 6.70 |
| (6) | 9877000104 | 2 | 8.05 ±0.20 0.317 | 19.00 ±0.40 0.750 | 12.70 ±0.25 0.500 | 5.55 +0.25 0.225 | 2.70 +0.25 0.111 | 8.05 ±0.20 0.317 | 3.00 |
| (7) | 9877000204 | 3 | 11.30 ±0.25 0.445 | 25.00 ±0.50 0.984 | 18.95 ±0.45 0.746 | 7.50 ±0.25 0.295 | 7.45 ±0.25 0.293 | 11.40 ±0.40 0.449 | 8.40 |
| (8) | 9677142009 | 4 | 14.00 ±0.35 0.551 | 20.00 ±0.70 0.788 | 12.50 ±0.30 0.492 | 9.00 ±0.30 0.354 | 2.00 ±0.30 0.079 | 3.20 ±0.10 0.126 | 8.50 |
| (9) | 9677182009 | 4 | 18.00 ±0.45 0.709 | 20.00 ±0.70 0.788 | 12.50 ±0.30 0.492 | 11.00 ±0.30 0.433 | 2.50 ±0.30 0.098 | 3.20 ±0.10 0.126 | 13.00 |
| (10) | 9677182209 | 4 | 18.00 ±0.45 0.709 | 22.00 ±0.70 0.866 | 14.50 ±0.35 0.570 | 11.00 ±0.30 0.433 | 2.50 ±0.30 0.098 | 3.20 ±0.10 0.126 | 14.00 |
| (11) | 9677242009 | 4 | 24.00 ±0.60 0.945 | 20.00 ±0.70 0.788 | 12.50 ±0.30 0.492 | 13.00 ±0.30 0.512 | 3.00 ±0.30 0.118 | 3.20 ±0.10 0.126 | 22.00 |
| (12) | 9677242409 | 4 | 24.00 ±0.60 0.945 | 24.00 ±0.70 0.946 | 16.50 ±0.40 0.650 | 13.00 ±0.30 0.512 | 3.00 ±0.30 0.118 | 3.20 ±0.10 0.126 | 24.00 |
| (13) | 9677282009 | 4 | 28.00 ±0.70 1.102 | 20.00 ±0.70 0.788 | 12.50 ±0.30 0.492 | 17.00 ±0.40 0.670 | 3.00 ±0.30 0.118 | 4.20 ±0.15 0.165 | 33.00 |
| (14) | 9677282509 | 4 | 28.00 ±0.70 1.102 | 25.00 ±0.70 0.985 | 18.00 ±0.45 0.708 | 17.00 ±0.40 0.670 | 3.00 ±0.30 0.118 | 4.20 ±0.15 0.165 | 38.00 |
| (15) | 9677352509 | 4 | 35.00 ±0.90 1.381 | 25.00 ±0.70 0.985 | 18.00 ±0.45 0.708 | 21.00 ±0.50 0.825 | 3.00 ±0.30 0.118 | 6.90 ±0.40 0.272 | 56.00 |
| (16) | 9677353509 | 4 | 35.00 ±0.90 1.381 | 35.00 ±0.75 1.380 | 28.00 ±0.60 1.100 | 21.00 ±0.50 0.825 | 3.00 ±0.30 0.118 | 6.90 ±0.40 0.272 | 71.00 |
| (17) | 9677453509 | 4 | 45.00 ±1.00 1.771 | 35.00 ±0.75 1.380 | 26.00 ±0.60 1.024 | 27.00 ±0.50 1.063 | 3.60 ±0.30 0.142 | 9.00 ±0.30 0.354 | 127.00 |

Quick Link: www.fair-rite.com/bob

Table Continued ...

| Row # | Part Number | A _L (nH) | A _L min. @ NI(At) | N/AWG | A _w (cm ²) |
|-------|-------------|---------------------|------------------------------|--------|-----------------------------------|
| (4) | 9677001165 | 18 ±10% | 15 - 90 | 30/24 | 0.12 |
| (5) | 9677001015 | 39 ±10% | 33 - 125 | 75/24 | 0.30 |
| (6) | 9877000104 | 39 ±10% | 33 - 125 | 36/24 | 0.33 |
| (7) | 9877000204 | 49 ±10% | 42 - 360 | 45/24 | 0.37 |
| (8) | 9677142009 | 55 ±10% | 47 - 325 | 81/28 | 0.31 |
| (9) | 9677182009 | 66 ±10% | 56 - 400 | 50/20 | 0.44 |
| (10) | 9677182209 | 65 ±10% | 55 - 410 | 95/22 | 0.51 |
| (11) | 9677242009 | 88 ±10% | 75 - 430 | 50/18 | 0.69 |
| (12) | 9677242409 | 84 ±10% | 72 - 450 | 67/18 | 0.91 |
| (13) | 9677282009 | 100 ±10% | 86 - 470 | 40/18 | 0.69 |
| (14) | 9677282509 | 95 ±10% | 81 - 520 | 55/18 | 0.99 |
| (15) | 9677352509 | 124 ±10% | 106 - 580 | 55/16 | 1.27 |
| (16) | 9677353509 | 110 ±10% | 94 - 700 | 70/16 | 1.97 |
| (17) | 9677453509 | 142 ±10% | 121 - 750 | 100/16 | 2.34 |

Quick Link: www.fair-rite.com/tor

A ring configuration provides the ultimate utilization of the intrinsic ferrite material properties. Toroidal cores are used in a wide variety of applications such as power input filters, ground-fault interrupters, common-mode filters and in pulse and broadband transformers.

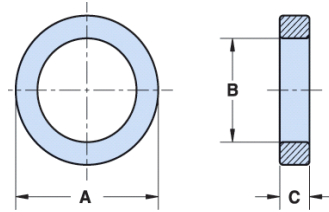

- Toroids are listed by initial permeability classes and increasing dimension of the inside diameter.
- All toroidal cores are supplied burnished to break sharp edges.
- Toroids are tested for A_L values at 10 kHz.
- Toroids with an outside diameter of 9.5 mm (0.375") or smaller can be supplied Parylene C coated. The Parylene coating will increase the "A" and "C" dimensions and decrease the "B" dimension a maximum of 0.038 mm (0.0015"). The ninth digit of a Parylene coated toroid part number is a "1". See reference tables for the material characteristics of Parylene C. Parylene C coating is RoHS compliant.
- Toroids with an outside diameter of 9.5 mm (0.375") or larger can be supplied with a uniform coating of thermo-set plastic coating. This coating will increase the "A" and "C" dimensions and decrease the "B" dimension a maximum of 0.5 mm (0.020"). The 9th digit of the thermo-set plastic coated toroid part number is a "2". Thermo-set plastic coating is RoHS compliant.
- Thermo-set plastic coated parts can withstand a minimum breakdown voltage of 1000 Vrms, uniformly applied across the "C" dimension of the toroid.
- The "C" dimension may be modified to suit specific applications.
- For any toroidal core requirement not listed in the catalog, please contact our customer service department for availability and pricing.
- Explanation of Part Numbers: Digits 1&2 = product class, 3&4 = material grade, 9th digit 1 = Parylene coating, 2 = thermo-set plastic coating.

Legend: Symbols & Definition

Dimensions (Top numbers are in millimeters, bottom numbers are in nominal inches.)

$\Sigma \ell/A$: Core Constant, ℓ_e : Effective Path Length, A_e : Effective Cross-Sectional Area, V_e : Effective Core Volume, A_L : Inductance Factor ($\frac{L}{N^2}$)

Low Permeability, 68 ($\mu_i=16$) material

| Part Number | A | B | C | Wt. (g) | $\Sigma \ell A (\text{cm}^{-1})$ | $\ell_e (\text{cm})$ | $A_e (\text{cm}^2)$ | $V_e (\text{cm}^3)$ | $A_L (\text{nH})$ |
|-------------|----------------------|----------------------|---------------------|---------|----------------------------------|----------------------|---------------------|---------------------|-------------------|
| 5968020901 | 6.10 -0.25 0.235 | 3.12 ±0.10 0.123 | 1.65 -0.25 0.060 | 0.19 | 63.68 | 1.33 | 0.021 | 0.027 | 2.3 Min |
| 5968000201 | 9.50 ±0.20 0.740 | 4.75 ±0.15 0.187 | 3.30 -0.25 0.125 | 0.83 | 28.60 | 2.07 | 0.073 | 0.15 | 5.3 Min |
| 5968000301 | 12.70 ±0.25 0.500 | 7.15 ±0.20 0.281 | 4.90 -0.25 0.188 | 2.00 | 22.90 | 2.95 | 0.129 | 0.38 | 6.6 Min |
| 5968001101 | 12.70 ±0.25 0.500 | 7.90 ±0.20 0.311 | 6.35 ±0.25 0.250 | 2.40 | 20.80 | 3.12 | 0.15 | 0.47 | 7.2 Min |
| 5968001801 | 22.10 ±0.40 0.870 | 13.70 ±0.30 0.539 | 6.35 ±0.25 0.250 | 7.20 | 20.70 | 5.41 | 0.262 | 1.42 | 7.3 Min |
| 5968021001 | 29.95 ±0.65 1.179 | 19.45 ±0.50 0.766 | 7.50 ±0.25 0.295 | 21.80 | 19.39 | 7.52 | 0.388 | 2.917 | 7.7 Min |

Fair-Rite Products Corp. PO Box 288, One Commercial Row, Wallkill, NY 12589-0288

Quick Link: www.fair-rite.com/tor

Low Permeability, 68 ($\mu_i=16$) material

| Part Number | A | B | C | Wt. (g) | $\sum l/A(\text{cm}^{-1})$ | $l_e(\text{cm})$ | $A_e(\text{cm}^2)$ | $V_e(\text{cm}^3)$ | $A_L(\text{nH})$ |
|-------------|----------------------|----------------------|----------------------|---------|----------------------------|------------------|--------------------|--------------------|------------------|
| 5968002701 | 35.55 ±0.75 1.400 | 23.00 ±0.55 0.906 | 12.70 ±0.50 0.500 | 33.00 | 11.20 | 8.90 | 0.78 | 7.00 | 13 Min |
| 5968003801 | 61.00 ±1.30 2.402 | 35.55 ±0.85 1.400 | 12.70 ±0.50 0.500 | 106.00 | 9.20 | 14.50 | 1.58 | 22.80 | 16 Min |

Low Permeability, 67 ($\mu_i=40$) material

| Part Number | A | B | C | Wt. (g) | $\sum l/A(\text{cm}^{-1})$ | $l_e(\text{cm})$ | $A_e(\text{cm}^2)$ | $V_e(\text{cm}^3)$ | $A_L(\text{nH})$ |
|-------------|------------------------|------------------------|------------------------|---------|----------------------------|------------------|--------------------|--------------------|------------------|
| 5967000101 | 5.95 -0.25 0.230 | 3.05 ±0.10 0.120 | 1.65 -0.25 0.060 | 0.14 | 63.80 | 1.30 | 0.02 | 0.027 | 6 Min |
| 5967000201 | 9.50 ±0.20 0.375 | 4.75 ±0.15 0.187 | 3.30 -0.25 0.125 | 0.83 | 28.60 | 2.07 | 0.072 | 0.15 | 18 +35%, -25% |
| 5967000301 | 12.70 ±0.25 0.500 | 7.15 ±0.20 0.281 | 4.90 -0.25 0.188 | 2.00 | 22.90 | 2.95 | 0.129 | 0.38 | 22 +35%, -25% |
| 5967001101 | 12.70 ±0.25 0.500 | 7.90 ±0.20 0.312 | 6.35 ±0.25 0.250 | 2.40 | 20.80 | 3.12 | 0.15 | 0.47 | 24 +35%, -25% |
| 5967001901 | 12.70 ±0.25 0.500 | 7.90 ±0.20 0.312 | 12.70 ±0.35 0.500 | 4.70 | 10.40 | 3.12 | 0.299 | 0.93 | 48 +35%, -25% |
| 5967000601 | 21.00 ±0.35 0.825 | 13.20 ±0.30 0.520 | 6.35 ±0.25 0.250 | 6.40 | 21.30 | 5.20 | 0.243 | 1.26 | 24 +35%, -25% |
| 5967001801 | 22.10 ±0.40 0.870 | 13.70 ±0.30 0.540 | 6.35 ±0.25 0.250 | 7.20 | 20.70 | 5.40 | 0.262 | 1.42 | 24 +35%, -25% |
| 5967001001 | 29.00 ±0.65 1.142 | 19.00 ±0.50 0.748 | 7.50 ±0.25 0.295 | 13.00 | 19.80 | 7.30 | 0.37 | 2.70 | 25 +35%, -25% |
| 5967001201 | 29.00 ±0.65 1.142 | 19.00 ±0.50 0.748 | 13.85 ±0.30 0.545 | 26.00 | 10.70 | 7.30 | 0.68 | 5.00 | 47 +35%, -25% |
| 5967001701 | 31.75 ±0.75 1.250 | 19.05 ±0.50 0.750 | 9.50 ±0.30 0.375 | 23.00 | 12.90 | 7.60 | 0.59 | 4.50 | 39 +35%, -25% |
| 5967002701 | 35.55 ±0.75 1.400 | 23.00 ±0.55 0.900 | 12.70 ±0.50 0.500 | 33.00 | 11.20 | 8.90 | 0.79 | 7.00 | 45 +35%, -25% |
| 5967003821 | 62.80 Max 2.472 Max | 34.20 Min 1.346 Min | 13.70 Max 0.539 Max | 106.00 | 9.20 | 14.50 | 1.58 | 22.80 | 55 +35%, -25% |
| 5967003801 | 61.00 ±1.30 2.400 | 35.55 ±0.85 1.400 | 12.70 ±0.50 0.500 | 106.00 | 9.20 | 14.50 | 1.58 | 22.80 | 55 +35%, -25% |

Low Permeability, 61 ($\mu_i=125$) material

| Part Number | A | B | C | Wt. (g) | $\sum l/A(\text{cm}^{-1})$ | $l_e(\text{cm})$ | $A_e(\text{cm}^2)$ | $V_e(\text{cm}^3)$ | $A_L(\text{nH})$ |
|-------------|------------------------|-----------------------|-----------------------|---------|----------------------------|------------------|--------------------|--------------------|------------------|
| 5961000801 | 3.95 ±0.15 0.155 | 2.15 +0.15 0.088 | 1.40 -0.25 0.050 | 0.05 | 87.60 | 0.92 | 0.011 | 0.0097 | 15 Min |
| 5961000811 | 4.14 Max 0.162 Max | 2.11 Min 0.084 Min | 1.44 Max 0.056 Max | 0.05 | 87.60 | 0.92 | 0.011 | 0.0097 | 15 Min |
| 5961000101 | 5.95 -0.25 0.230 | 3.05 ±0.10 0.120 | 1.65 -0.25 0.060 | 0.14 | 63.80 | 1.30 | 0.02 | 0.027 | 25 ±25% |
| 5961000111 | 5.99 Max 0.235 Max | 2.91 Min 0.115 Min | 1.69 Max 0.066 Max | 0.14 | 63.80 | 1.30 | 0.02 | 0.027 | 25 ±25% |
| 5961000201 | 9.50 ±0.20 0.375 | 4.75 ±0.15 0.187 | 3.30 -0.25 0.125 | 0.83 | 28.60 | 2.07 | 0.072 | 0.15 | 55 ±25% |
| 5961000211 | 9.74 Max 0.383 Max | 4.56 Min 0.180 Min | 3.34 Max 0.132 Max | 0.83 | 28.60 | 2.07 | 0.072 | 0.15 | 55 ±25% |
| 5961000221 | 10.20 Max 0.401 Max | 4.10 Min 0.162 Min | 3.80 Max 0.149 Max | 0.83 | 28.60 | 2.07 | 0.072 | 0.15 | 55 ±25% |
| 5961000301 | 12.70 ±0.25 0.500 | 7.15 ±0.20 0.281 | 4.90 -0.25 0.188 | 2.00 | 22.90 | 2.95 | 0.129 | 0.38 | 69 ±25% |

Fair-Rite Products Corp. PO Box 288, One Commercial Row, Wallkill, NY 12589-0288

Phone: (888) FAIR RITE / (845) 895-2055 • Fax: (888) FERRITE / (845) 895-2629 • Web: www.fair-rite.com
(888) 324-7748 (888) 337-7483 E -mail: ferrites@fair-rite.com

Low Permeability, 61 ($\mu_i=125$) material

| Part Number | A | B | C | Wt. (g) | $\sum lA(\text{cm}^2)$ | $l_e(\text{cm})$ | $A_e(\text{cm}^2)$ | $V_e(\text{cm}^3)$ | $A_L(\text{nH})$ |
|-------------|------------------------|------------------------|------------------------|---------|------------------------|------------------|--------------------|--------------------|------------------|
| 5961000321 | 13.45 Max 0.529 Max | 6.45 Min 0.254 Min | 5.40 Max 0.212 Max | 2.00 | 22.90 | 2.95 | 0.129 | 0.38 | 69 ±25% |
| 5961001101 | 12.70 ±0.25 0.500 | 7.90 ±0.20 0.312 | 6.35 ±0.25 0.250 | 2.40 | 20.80 | 3.12 | 0.15 | 0.47 | 75 ±25% |
| 5961001121 | 13.45 Max 0.529 Max | 7.20 Min 0.283 Min | 7.10 Max 0.280 Max | 2.40 | 20.80 | 3.12 | 0.15 | 0.47 | 75 ±25% |
| 5961001901 | 12.70 ±0.25 0.500 | 7.90 ±0.20 0.312 | 12.70 ±0.35 0.500 | 4.70 | 10.40 | 3.12 | 0.299 | 0.93 | 150 ±25% |
| 5961001921 | 13.45 Max 0.529 Max | 7.20 Min 0.283 Min | 13.55 Max 0.533 Max | 4.70 | 10.40 | 3.12 | 0.299 | 0.93 | 150 ±25% |
| 5961004901 | 16.00 ±0.40 0.630 | 9.60 ±0.30 0.378 | 6.35 ±0.25 0.250 | 4.00 | 19.40 | 3.85 | 0.199 | 0.77 | 80 ±25% |
| 5961004921 | 16.90 Max 0.665 Max | 8.80 Min 0.347 Min | 7.10 Max 0.280 Max | 4.00 | 19.40 | 3.85 | 0.199 | 0.77 | 80 ±25% |
| 5961000601 | 21.00 ±0.35 0.825 | 13.20 ±0.30 0.520 | 6.35 ±0.25 0.250 | 6.40 | 21.30 | 5.20 | 0.243 | 1.26 | 75 ±25% |
| 5961000621 | 21.85 Max 0.860 Max | 12.40 Min 0.489 Min | 7.10 Max 0.280 Max | 6.40 | 21.30 | 5.20 | 0.243 | 1.26 | 75 ±25% |
| 5961000501 | 21.00 ±0.35 0.825 | 13.20 ±0.30 0.520 | 11.90 ±0.40 0.468 | 12.00 | 11.40 | 5.20 | 0.46 | 2.36 | 135 ±25% |
| 5961001801 | 22.10 ±0.40 0.870 | 13.70 ±0.30 0.540 | 6.35 ±0.25 0.250 | 7.20 | 20.70 | 5.40 | 0.262 | 1.42 | 75 ±25% |
| 5961001821 | 23.00 Max 0.905 Max | 12.90 Min 0.508 Min | 7.10 Max 0.280 Max | 7.20 | 20.70 | 5.40 | 0.262 | 1.42 | 75 ±25% |
| 5961001001 | 29.00 ±0.65 1.142 | 19.00 ±0.50 0.748 | 7.50 ±0.25 0.295 | 13.00 | 19.80 | 7.30 | 0.37 | 2.70 | 80 ±25% |
| 5961001021 | 30.15 Max 1.187 Max | 18.00 Min 0.708 Min | 8.25 Max 0.325 Max | 13.00 | 19.80 | 7.30 | 0.37 | 2.70 | 80 ±25% |
| 5961001201 | 29.00 ±0.65 1.142 | 19.00 ±0.50 0.748 | 13.85 ±0.30 0.545 | 26.00 | 10.70 | 7.30 | 0.68 | 5.00 | 145 ±25% |
| 5961001221 | 30.15 Max 1.187 Max | 18.00 Min 0.708 Min | 14.65 Max 0.576 Max | 26.00 | 10.70 | 7.30 | 0.68 | 5.00 | 145 ±25% |
| 5961001701 | 31.75 ±0.75 1.250 | 19.05 ±0.50 0.750 | 9.50 ±0.30 0.375 | 23.00 | 12.90 | 7.60 | 0.59 | 4.50 | 120 ±25% |
| 5961001721 | 33.00 Max 1.299 Max | 18.05 Min 0.729 Min | 10.30 Max 0.405 Max | 23.00 | 12.90 | 7.60 | 0.59 | 4.50 | 120 ±25% |
| 5961002701 | 35.55 ±0.75 1.400 | 23.00 ±0.55 0.900 | 12.70 ±0.50 0.500 | 33.00 | 11.20 | 8.90 | 0.79 | 7.00 | 140 ±25% |
| 5961002721 | 36.80 Max 1.449 Max | 21.95 Min 0.864 Min | 13.70 Max 0.539 Max | 33.00 | 11.20 | 8.90 | 0.79 | 7.00 | 140 ±25% |
| 5961003801 | 61.00 ±1.30 2.400 | 35.55 ±0.85 1.400 | 12.70 ±0.50 0.500 | 106.00 | 9.20 | 14.50 | 1.58 | 22.80 | 170 ±25% |
| 5961003821 | 62.80 Max 2.472 Max | 34.20 Min 1.346 Min | 13.70 Max 0.539 Max | 106.00 | 9.20 | 14.50 | 1.58 | 22.80 | 170 ±25% |

Low-Medium Permeability, 52 ($\mu_i=250$) material

| Part Number | A | B | C | Wt. (g) | $\sum lA(\text{cm}^2)$ | $l_e(\text{cm})$ | $A_e(\text{cm}^2)$ | $V_e(\text{cm}^3)$ | $A_L(\text{nH})$ |
|-------------|----------------------|---------------------|---------------------|---------|------------------------|------------------|--------------------|--------------------|------------------|
| 5952020201 | 5.84 -0.26 0.225 | 3.00 ±0.10 0.118 | 1.65 -0.25 0.060 | 0.15 | 63.88 | 1.28 | 0.02 | 0.0256 | 49 ±25% |
| 5952020301 | 9.42 ±0.20 0.371 | 4.72 ±0.15 0.186 | 3.30 -0.25 0.125 | 0.87 | 28.66 | 2.06 | 0.072 | 0.147 | 110 ±25% |
| 5952020401 | 12.60 ±0.25 0.496 | 6.99 ±0.20 0.275 | 4.90 -0.25 0.188 | 2.16 | 22.31 | 2.90 | 0.13 | 0.378 | 141 ±25% |
| 5952020501 | 12.45 ±0.25 0.490 | 7.80 ±0.20 0.307 | 6.35 ±0.25 0.250 | 2.46 | 21.24 | 3.06 | 0.144 | 0.442 | 148 ±25% |

Quick Link: www.fair-rite.com/tor

Low-Medium Permeability, 52 ($\mu_i=250$) material

| Part Number | A | B | C | Wt. (g) | $\sum l/A(\text{cm}^{-1})$ | $l_e(\text{cm})$ | $A_e(\text{cm}^2)$ | $V_e(\text{cm}^3)$ | $A_L(\text{nH})$ |
|-------------|---------------------------|---------------------------|---------------------------|---------|----------------------------|------------------|--------------------|--------------------|------------------|
| 5952020601 | 21.70 \pm 0.40 0.854 | 13.50 \pm 0.30 0.531 | 6.35 \pm 0.25 0.250 | 7.54 | 20.80 | 5.33 | 0.256 | 1.368 | 151 \pm 25% |
| 5952020701 | 28.80 \pm 0.65 1.134 | 18.70 \pm 0.50 0.736 | 7.50 \pm 0.25 0.250 | 14.81 | 19.34 | 7.23 | 0.374 | 2.702 | 162 \pm 25% |
| 5952020801 | 35.25 \pm 0.75 1.388 | 22.60 \pm 0.55 0.890 | 12.70 \pm 0.50 0.500 | 38.26 | 11.10 | 8.79 | 0.792 | 6.959 | 283 \pm 25% |
| 5952003801 | 60.00 \pm 1.30 2.362 | 35.35 \pm 0.60 1.392 | 12.70 \pm 0.50 0.500 | 133.44 | 9.14 | 14.50 | 1.58 | 22.80 | 325 \pm 25% |

Low-Medium Permeability, 43 ($\mu_i=800$) material

| Part Number | A | B | C | Wt. (g) | $\sum l/A(\text{cm}^{-1})$ | $l_e(\text{cm})$ | $A_e(\text{cm}^2)$ | $V_e(\text{cm}^3)$ | $A_L(\text{nH})$ |
|-------------|---------------------------|---------------------------|---------------------------|---------|----------------------------|------------------|--------------------|--------------------|-------------------|
| 5943000801 | 3.95 \pm 0.15 0.155 | 2.15 \pm 0.15 0.088 | 1.40 -0.25 0.050 | 0.05 | 87.60 | 0.92 | 0.011 | 0.0097 | 117 \pm 20% |
| 5943000101 | 5.95 -0.25 0.230 | 3.05 \pm 0.10 0.120 | 1.65 -0.25 0.060 | 0.14 | 63.80 | 1.30 | 0.02 | 0.027 | 158 \pm 20% |
| 5943000111 | 5.99 Max 0.235 Max | 2.91 Min 0.115 Min | 1.69 Max 0.066 Max | 0.14 | 63.80 | 1.30 | 0.02 | 0.027 | 158 \pm 20% |
| 5943000901 | 5.95 -0.25 0.230 | 3.05 \pm 0.10 0.120 | 3.05 \pm 0.10 0.120 | 0.29 | 31.80 | 1.30 | 0.041 | 0.053 | 315 \pm 20% |
| 5943000911 | 5.99 Max 0.235 Max | 2.91 Min 0.115 Min | 3.19 Max 0.126 Max | 0.29 | 31.80 | 1.30 | 0.041 | 0.053 | 315 \pm 20% |
| 5943000201 | 9.50 \pm 0.20 0.375 | 4.75 \pm 0.15 0.187 | 3.30 -0.25 0.125 | 0.83 | 28.60 | 2.07 | 0.072 | 0.15 | 350 \pm 20% |
| 5943000211 | 9.74 Max 0.383 Max | 4.56 Min 0.180 Min | 3.34 Max 0.132 Max | 0.83 | 28.60 | 2.07 | 0.072 | 0.15 | 350 \pm 20% |
| 5943000221 | 10.20 Max 0.401 Max | 4.10 Min 0.162 Min | 3.80 Max 0.149 Max | 0.83 | 28.60 | 2.07 | 0.072 | 0.15 | 350 +20%, -25% |
| 5943000301 | 12.70 \pm 0.25 0.500 | 7.15 \pm 0.20 0.281 | 4.90 -0.25 0.188 | 2.00 | 22.90 | 2.95 | 0.129 | 0.38 | 440 \pm 20% |
| 5943000321 | 13.45 Max 0.529 Max | 6.45 Min 0.254 Min | 5.40 Max 0.213 Max | 2.00 | 22.90 | 2.95 | 0.129 | 0.38 | 440 +20%, -25% |
| 5943001101 | 12.70 \pm 0.25 0.500 | 7.90 \pm 0.20 0.312 | 6.35 \pm 0.25 0.250 | 2.40 | 20.80 | 3.12 | 0.15 | 0.47 | 480 \pm 20% |
| 5943001121 | 13.45 Max 0.529 Max | 7.20 Min 0.283 Min | 7.10 Max 0.280 Max | 2.40 | 20.80 | 3.12 | 0.15 | 0.47 | 480 +20%, -25% |
| 5943001901 | 12.70 \pm 0.25 0.500 | 7.90 \pm 0.20 0.312 | 12.70 \pm 0.35 0.500 | 4.70 | 10.40 | 3.12 | 0.299 | 0.93 | 965 \pm 20% |
| 5943001921 | 13.45 Max 0.529 Max | 7.20 Min 0.283 Min | 13.55 Max 0.533 Max | 4.70 | 10.40 | 3.12 | 0.299 | 0.93 | 965 +20%, -25% |
| 5943005101 | 16.00 \pm 0.40 0.630 | 9.60 \pm 0.30 0.378 | 4.75 -0.25 0.182 | 2.80 | 26.60 | 3.85 | 0.145 | 0.56 | 375 \pm 20% |
| 5943004901 | 16.00 \pm 0.40 0.630 | 9.60 \pm 0.30 0.378 | 6.35 \pm 0.25 0.250 | 4.00 | 19.40 | 3.85 | 0.199 | 0.77 | 520 \pm 20% |
| 5943004921 | 16.90 Max 0.665 Max | 8.80 Min 0.347 Min | 7.10 Max 0.280 Max | 4.00 | 19.40 | 3.85 | 0.199 | 0.77 | 520 +20%, -25% |
| 5943000601 | 21.00 \pm 0.35 0.825 | 13.20 \pm 0.30 0.520 | 6.35 \pm 0.25 0.250 | 6.40 | 21.30 | 5.20 | 0.243 | 1.26 | 470 \pm 20% |
| 5943000621 | 21.85 Max 0.860 Max | 12.40 Min 0.489 Min | 7.10 Max 0.280 Max | 6.40 | 21.30 | 5.20 | 0.243 | 1.26 | 470 +20%, -25% |
| 5943000501 | 21.00 \pm 0.35 0.825 | 13.20 \pm 0.30 0.520 | 11.90 \pm 0.40 0.468 | 12.00 | 11.40 | 5.20 | 0.46 | 2.36 | 885 \pm 20% |
| 5943000521 | 21.85 Max 0.860 Max | 12.40 Min 0.489 Min | 12.80 Max 0.503 Max | 12.00 | 11.40 | 5.20 | 0.46 | 2.36 | 885 +20%, -25% |
| 5943001801 | 22.10 \pm 0.40 0.870 | 13.70 \pm 0.30 0.540 | 6.35 \pm 0.25 0.250 | 7.20 | 20.70 | 5.40 | 0.262 | 1.42 | 485 \pm 20% |

Low-Medium Permeability, 43 ($\mu_i=800$) material

| Part Number | A | B | C | Wt. (g) | $\sum lA(\text{cm}^2)$ | $l_e(\text{cm})$ | $A_e(\text{cm}^2)$ | $V_e(\text{cm}^3)$ | $A_L(\text{nH})$ |
|-------------|----------------------------|---------------------------|---------------------------|---------|------------------------|------------------|--------------------|--------------------|--------------------|
| 5943001821 | 23.00 Max 0.905 Max | 12.90 Min 0.508 Min | 7.10 Max 0.279 Max | 7.20 | 20.70 | 5.40 | 0.262 | 1.42 | 485 +20%, -25% |
| 5943007601 | 22.10 \pm 0.40 0.870 | 13.70 \pm 0.30 0.540 | 12.70 \pm 0.45 0.500 | 15.00 | 10.30 | 5.40 | 0.52 | 2.83 | 970 \pm 20% |
| 5943001301 | 25.40 \pm 0.60 1.000 | 15.50 \pm 0.50 0.610 | 6.35 \pm 0.25 0.250 | 9.60 | 20.00 | 6.20 | 0.308 | 1.90 | 500 \pm 20% |
| 5943001401 | 25.40 \pm 0.60 1.000 | 15.50 \pm 0.50 0.610 | 8.15 \pm 0.30 0.320 | 12.00 | 15.10 | 6.20 | 0.41 | 2.52 | 645 \pm 20% |
| 5943001421 | 26.50 Max 1.043 Max | 14.50 Min 0.571 Min | 8.95 Max 0.352 Max | 12.00 | 15.10 | 6.20 | 0.41 | 2.52 | 645 +20%, -25% |
| 5943006401 | 25.40 \pm 0.60 1.000 | 15.50 \pm 0.50 0.610 | 12.70 \pm 0.50 0.500 | 19.00 | 10.00 | 6.20 | 0.62 | 3.80 | 1000 \pm 20% |
| 5943006421 | 26.50 Max 1.043 Max | 14.50 Min 0.571 Min | 13.70 Max 0.539 Max | 19.00 | 10.00 | 6.20 | 0.62 | 3.80 | 1000 +20%, -25% |
| 5943001001 | 29.00 \pm 0.65 1.142 | 19.00 \pm 0.50 0.748 | 7.50 \pm 0.25 0.295 | 13.00 | 19.80 | 7.30 | 0.37 | 2.70 | 510 \pm 20% |
| 5943001021 | 30.15 Max 1.187 Max | 18.00 Min 0.708 Min | 8.25 Max 0.325 Max | 13.00 | 19.80 | 7.30 | 0.37 | 2.70 | 510 +20%, -25% |
| 5943001201 | 29.00 \pm 0.65 1.142 | 19.00 \pm 0.50 0.748 | 13.85 \pm 0.30 0.545 | 26.00 | 10.70 | 7.30 | 0.68 | 5.00 | 950 \pm 20% |
| 5943001601 | 31.10 \pm 0.75 1.225 | 19.05 \pm 0.50 0.750 | 7.90 \pm 0.30 0.312 | 18.00 | 16.20 | 7.60 | 0.47 | 3.53 | 620 \pm 20% |
| 5943001701 | 31.75 \pm 0.75 1.250 | 19.05 \pm 0.50 0.750 | 9.50 \pm 0.30 0.375 | 23.00 | 12.90 | 7.60 | 0.59 | 4.50 | 775 \pm 20% |
| 5943002701 | 35.55 \pm 0.75 1.400 | 23.00 \pm 0.55 0.900 | 12.70 \pm 0.50 0.500 | 33.00 | 11.20 | 8.90 | 0.79 | 7.00 | 885 \pm 20% |
| 5943002721 | 36.80 Max 1.449 Max | 21.95 Min 0.864 Min | 13.70 Max 0.539 Max | 33.00 | 11.20 | 8.90 | 0.79 | 7.00 | 885 +20%, -25% |
| 5943018601 | 43.60 \pm 1.00 1.717 | 23.10 \pm 0.50 0.909 | 18.00 \pm 0.50 0.709 | 90.00 | 5.50 | 9.80 | 1.78 | 17.50 | 1850 \pm 25% |
| 5943017301 | 48.30 \pm 1.00 1.902 | 31.80 \pm 0.60 1.252 | 19.05 \pm 0.35 0.750 | 94.00 | 7.90 | 12.20 | 1.55 | 18.90 | 1275 \pm 25% |
| 5943003801 | 61.00 \pm 1.30 2.400 | 35.55 \pm 0.85 1.400 | 12.70 \pm 0.50 0.500 | 106.00 | 9.20 | 14.50 | 1.58 | 22.80 | 1075 \pm 20% |
| 5943003821 | 62.80 Max 2.472 Max | 34.20 Min 1.347 Min | 13.70 Max 0.539 Max | 106.00 | 9.20 | 14.50 | 1.58 | 22.80 | 1075 +20%, -25% |
| 5943011101 | 73.65 \pm 1.50 2.900 | 38.85 \pm 0.75 1.530 | 12.70 \pm 0.40 0.500 | 188.00 | 7.80 | 16.70 | 2.15 | 35.90 | 1300 \pm 25% |
| 5943011121 | 75.85 Max 2.978 Max | 37.60 Min 1.480 Min | 13.60 Max 0.535 Max | 188.00 | 7.80 | 16.70 | 2.15 | 35.90 | 1300 +25%, -30% |
| 5943015901 | 100.00 \pm 2.00 3.937 | 55.00 \pm 1.20 2.165 | 12.70 \pm 0.30 0.500 | 320.00 | 8.30 | 23.00 | 2.77 | 63.70 | 1215 \pm 25% |
| 5943017501 | 102.60 \pm 2.10 4.039 | 63.50 \pm 1.30 2.500 | 15.85 \pm 0.35 0.624 | 360.00 | 8.30 | 25.10 | 3.00 | 70.50 | 1225 \pm 25% |

Medium Permeability, 77 ($\mu_i=2000$) & 78 ($\mu_i=2300$) materials

| Part Number | A | B | C | Wt. (g) | $\sum lA(\text{cm}^2)$ | $l_e(\text{cm})$ | $A_e(\text{cm}^2)$ | $V_e(\text{cm}^3)$ | $A_L(\text{nH})$ |
|-------------|--------------------------|--------------------------|-----------------------|---------|------------------------|------------------|--------------------|--------------------|------------------|
| 5978002101 | 4.95 -0.25 0.190 | 2.20 +0.15 0.090 | 1.40 -0.25 0.050 | 0.09 | 69.20 | 1.04 | 0.015 | 0.0157 | 440 \pm 25% |
| 5977000101 | 5.95 -0.25 0.230 | 3.05 \pm 0.10 0.120 | 1.65 -0.25 0.060 | 0.14 | 63.80 | 1.30 | 0.02 | 0.027 | 420 \pm 25% |
| 5977000201 | 9.50 \pm 0.20 0.375 | 4.75 \pm 0.15 0.187 | 3.30 -0.25 0.125 | 0.83 | 28.60 | 2.07 | 0.072 | 0.15 | 945 \pm 25% |
| 5977000211 | 9.74 Max 0.383 Max | 4.56 Min 0.180 Min | 3.34 Max 0.131 Max | 0.83 | 28.60 | 2.07 | 0.072 | 0.15 | 945 \pm 25% |

Quick Link: www.fair-rite.com/tor

Medium Permeability, 77 ($\mu_i=2000$) & 78 ($\mu_i=2300$) materials

| Part Number | A | B | C | Wt. (g) | $\sum l/A(\text{cm}^{-1})$ | $l_e(\text{cm})$ | $A_e(\text{cm}^2)$ | $V_e(\text{cm}^3)$ | $A_L(\text{nH})$ |
|-------------|---------------------------|---------------------------|---------------------------|---------|----------------------------|------------------|--------------------|--------------------|--------------------|
| 5977000221 | 10.20 Max 0.401 Max | 4.10 Min 0.162 Min | 3.80 Max 0.149 Max | 0.83 | 28.60 | 2.07 | 0.072 | 0.15 | 945 +25%, -30% |
| 5977000301 | 12.70 \pm 0.25 0.500 | 7.15 \pm 0.20 0.281 | 4.90 -0.25 0.188 | 2.00 | 22.90 | 2.95 | 0.129 | 0.38 | 1180 \pm 25% |
| 5977000321 | 13.45 Max 0.529 Max | 6.45 Min 0.254 Min | 5.40 Max 0.212 Max | 2.00 | 22.90 | 2.95 | 0.129 | 0.38 | 1180 +25%, -30% |
| 5977001101 | 12.70 \pm 0.25 0.500 | 7.90 \pm 0.20 0.312 | 6.35 \pm 0.25 0.250 | 2.40 | 20.80 | 3.12 | 0.15 | 0.47 | 1300 \pm 25% |
| 5977001121 | 13.45 Max 0.529 Max | 7.20 Min 0.284 Min | 7.10 Max 0.279 Max | 2.40 | 20.80 | 3.12 | 0.15 | 0.47 | 1300 +25%, -30% |
| 5977001901 | 12.70 \pm 0.25 0.500 | 7.90 \pm 0.20 0.312 | 12.70 \pm 0.35 0.500 | 4.70 | 10.40 | 3.12 | 0.299 | 0.93 | 2595 \pm 25% |
| 5977001921 | 13.45 Max 0.529 Max | 7.20 Min 0.284 Min | 13.55 Max 0.533 Max | 4.70 | 10.40 | 3.12 | 0.299 | 0.93 | 2595 +25%, -30% |
| 5977005101 | 16.00 \pm 0.40 0.630 | 9.60 \pm 0.30 0.378 | 4.75 -0.25 0.182 | 2.80 | 26.60 | 3.85 | 0.145 | 0.56 | 1015 \pm 25% |
| 5977004901 | 16.00 \pm 0.40 0.630 | 9.60 \pm 0.30 0.378 | 6.35 \pm 0.25 0.250 | 4.00 | 19.40 | 3.85 | 0.199 | 0.77 | 1400 \pm 25% |
| 5977000601 | 21.00 \pm 0.35 0.825 | 13.20 \pm 0.30 0.520 | 6.35 \pm 0.25 0.250 | 6.40 | 21.30 | 5.20 | 0.243 | 1.26 | 1270 \pm 25% |
| 5977000621 | 21.85 Max 0.860 Max | 12.40 Min 0.489 Min | 7.10 Max 0.279 Max | 6.40 | 21.30 | 5.20 | 0.243 | 1.26 | 1270 +25%, -30% |
| 5977000501 | 21.00 \pm 0.35 0.825 | 13.20 \pm 0.30 0.520 | 11.90 \pm 0.40 0.468 | 12.00 | 11.40 | 5.20 | 0.46 | 2.36 | 2375 \pm 25% |
| 5977001801 | 22.10 \pm 0.40 0.870 | 13.70 \pm 0.30 0.540 | 6.35 \pm 0.25 0.250 | 7.20 | 20.70 | 5.40 | 0.262 | 1.42 | 1305 \pm 25% |
| 5977001821 | 23.00 Max 0.905 Max | 12.90 Min 0.508 Min | 7.10 Max 0.279 Max | 7.20 | 20.70 | 5.40 | 0.262 | 1.42 | 1305 +25%, -30% |
| 5977007601 | 22.10 \pm 0.40 0.870 | 13.70 \pm 0.30 0.540 | 12.70 \pm 0.45 0.500 | 15.00 | 10.30 | 5.40 | 0.52 | 2.83 | 2615 \pm 25% |
| 5978007601 | 22.10 \pm 0.40 0.870 | 13.70 \pm 0.30 0.540 | 12.70 \pm 0.45 0.500 | 15.00 | 10.30 | 5.40 | 0.52 | 2.83 | 2795 \pm 25% |
| 5978007621 | 23.00 Max 0.905 Max | 12.90 Min 0.508 Min | 13.65 Max 0.537 Max | 15.00 | 10.30 | 5.40 | 0.52 | 2.83 | 2795 +25%, -30% |
| 5977001301 | 25.40 \pm 0.60 1.000 | 15.50 \pm 0.50 0.610 | 6.35 \pm 0.25 0.250 | 9.60 | 20.00 | 6.20 | 0.308 | 1.90 | 1350 \pm 25% |
| 5977001321 | 26.50 Max 1.043 Max | 14.50 Min 0.571 Min | 7.10 Max 0.279 Max | 9.60 | 20.00 | 6.20 | 0.308 | 1.90 | 1350 +25%, -30% |
| 5977001401 | 25.40 \pm 0.60 1.000 | 15.50 \pm 0.50 0.610 | 8.15 \pm 0.30 0.320 | 12.00 | 15.10 | 6.20 | 0.41 | 2.52 | 1730 \pm 25% |
| 5977001421 | 26.50 Max 1.043 Max | 14.50 Min 0.571 Min | 8.95 Max 0.352 Max | 12.00 | 15.10 | 6.20 | 0.41 | 2.52 | 1730 +25%, -30% |
| 5977006401 | 25.40 \pm 0.60 1.000 | 15.50 \pm 0.50 0.610 | 12.70 \pm 0.50 0.500 | 19.00 | 10.00 | 6.20 | 0.62 | 3.80 | 2700 \pm 25% |
| 5977001001 | 29.00 \pm 0.65 1.142 | 19.00 \pm 0.50 0.748 | 7.50 \pm 0.25 0.295 | 13.00 | 19.80 | 7.30 | 0.37 | 2.70 | 1365 \pm 25% |
| 5977001021 | 30.15 Max 1.187 Max | 18.00 Min 0.709 Min | 8.25 Max 0.324 Max | 13.00 | 19.80 | 7.30 | 0.37 | 2.70 | 1365 +25%, -30% |
| 5977001201 | 29.00 \pm 0.65 1.142 | 19.00 \pm 0.50 0.748 | 13.85 \pm 0.30 0.545 | 26.00 | 10.70 | 7.30 | 0.68 | 5.00 | 2520 \pm 25% |
| 5977001221 | 30.15 Max 1.187 Max | 18.00 Min 0.709 Min | 14.65 Max 0.576 Max | 26.00 | 10.70 | 7.30 | 0.68 | 5.00 | 2520 +25%, -30% |
| 5978001201 | 29.00 \pm 0.65 1.142 | 19.00 \pm 0.50 0.748 | 13.85 \pm 0.30 0.545 | 26.00 | 10.70 | 7.30 | 0.68 | 5.00 | 2695 \pm 25% |
| 5978001221 | 30.15 Max 1.187 Max | 18.00 Min 0.709 Min | 14.65 Max 0.576 Max | 26.00 | 10.70 | 7.30 | 0.68 | 5.00 | 2695 +25%, -30% |
| 5977001601 | 31.10 \pm 0.75 1.225 | 19.05 \pm 0.50 0.750 | 7.90 \pm 0.30 0.312 | 18.00 | 16.20 | 7.60 | 0.47 | 3.53 | 1665 \pm 25% |
| 5977001621 | 32.25 Max 1.273 Max | 18.05 Min 0.711 Min | 8.70 Max 0.342 Max | 18.00 | 16.20 | 7.60 | 0.47 | 3.53 | 1665 +25%, -30% |
| 5977001701 | 31.75 \pm 0.75 1.250 | 19.05 \pm 0.50 0.750 | 9.50 \pm 0.30 0.375 | 23.00 | 12.90 | 7.60 | 0.59 | 4.50 | 2090 \pm 25% |

Fair-Rite Products Corp. PO Box 288, One Commercial Row, Wallkill, NY 12589-0288

Phone: (888) FAIR RITE / (845) 895-2055 • Fax: (888) FERRITE / (845) 895-2629 • Web: www.fair-rite.com
 (888) 324-7748 (888) 337-7483 E -mail: ferrites@fair-rite.com

Medium Permeability, 77 ($\mu_i=2000$) & 78 ($\mu_i=2300$) materials

| Part Number | A | B | C | Wt. (g) | $\sum lA(\text{cm}^2)$ | $l_e(\text{cm})$ | $A_e(\text{cm}^2)$ | $V_e(\text{cm}^3)$ | $A_L(\text{nH})$ |
|-------------|----------------------------|---------------------------|---------------------------|---------|------------------------|------------------|--------------------|--------------------|--------------------|
| 5977001721 | 33.00 Max 1.299 Max | 18.05 Min 0.711 Min | 10.30 Max 0.405 Max | 23.00 | 12.90 | 7.60 | 0.59 | 4.50 | 2090 +25%, -30% |
| 5978001701 | 31.75 \pm 0.75 1.250 | 19.05 \pm 0.50 0.750 | 9.50 \pm 0.30 0.375 | 23.00 | 12.90 | 7.60 | 0.59 | 4.50 | 2230 \pm 25% |
| 5978001721 | 33.00 Max 1.299 Max | 18.05 Min 0.711 Min | 10.30 Max 0.405 Max | 23.00 | 12.90 | 7.60 | 0.59 | 4.50 | 2230 +25%, -30% |
| 5977002701 | 35.55 \pm 0.75 1.400 | 23.00 \pm 0.55 0.900 | 12.70 \pm 0.50 0.500 | 33.00 | 11.20 | 8.90 | 0.79 | 7.00 | 2400 \pm 25% |
| 5977002721 | 36.80 Max 1.448 Max | 21.95 Min 0.865 Min | 13.70 Max 0.539 Max | 33.00 | 11.20 | 8.90 | 0.79 | 7.00 | 2400 +25%, -30% |
| 5978002701 | 35.55 \pm 0.75 1.400 | 23.00 \pm 0.55 0.900 | 12.70 \pm 0.50 0.500 | 33.00 | 11.20 | 8.90 | 0.79 | 7.00 | 2545 \pm 25% |
| 5978002721 | 36.80 Max 1.448 Max | 21.95 Min 0.865 Min | 13.70 Max 0.539 Max | 33.00 | 11.20 | 8.90 | 0.79 | 7.00 | 2545 +25%, -30% |
| 5978018601 | 43.60 \pm 1.00 1.717 | 23.10 \pm 0.50 0.909 | 18.00 \pm 0.50 0.709 | 90.00 | 5.50 | 9.80 | 1.78 | 17.50 | 5260 \pm 25% |
| 5978017301 | 48.30 \pm 1.00 1.902 | 31.80 \pm 0.60 1.252 | 19.05 \pm 0.35 0.750 | 94.00 | 7.90 | 12.20 | 1.55 | 18.90 | 3670 \pm 25% |
| 5978017321 | 49.80 Max 1.960 Max | 30.70 Min 1.209 Min | 19.90 Max 0.783 Max | 94.00 | 7.90 | 12.20 | 1.55 | 18.90 | 3670 +25%, -30% |
| 5978018701 | 56.30 \pm 1.20 2.217 | 32.70 \pm 0.70 1.287 | 18.00 \pm 0.50 0.709 | 135.00 | 6.40 | 13.30 | 2.07 | 27.60 | 4500 \pm 25% |
| 5978018721 | 58.00 Max 2.283 Max | 31.50 Min 1.240 Min | 19.00 Max 0.748 Max | 135.00 | 6.40 | 13.30 | 2.07 | 27.60 | 4500 +25%, -30% |
| 5977003801 | 61.00 \pm 1.30 2.400 | 35.55 \pm 0.85 1.400 | 12.70 \pm 0.50 0.500 | 106.00 | 9.20 | 14.50 | 1.58 | 22.80 | 2950 \pm 25% |
| 5977003821 | 62.80 Max 2.472 Max | 34.20 Min 1.347 Min | 13.70 Max 0.539 Max | 106.00 | 9.20 | 14.50 | 1.58 | 22.80 | 2950 +25%, -30% |
| 5978003801 | 61.00 \pm 1.30 2.400 | 35.55 \pm 0.85 1.400 | 12.70 \pm 0.50 0.500 | 106.00 | 9.20 | 14.50 | 1.58 | 22.80 | 3155 \pm 25% |
| 5978003821 | 62.80 Max 2.472 Max | 34.20 Min 1.347 Min | 13.70 Max 0.539 Max | 106.00 | 9.20 | 14.50 | 1.58 | 22.80 | 3155 +25%, -30% |
| 5977011101 | 73.65 \pm 1.50 2.900 | 38.85 \pm 0.75 1.530 | 12.70 \pm 0.40 0.500 | 188.00 | 7.80 | 16.70 | 2.15 | 35.90 | 3500 \pm 25% |
| 5977011121 | 75.65 Max 2.978 Max | 37.60 Min 1.480 Min | 13.60 Max 0.535 Max | 188.00 | 7.80 | 16.70 | 2.15 | 35.90 | 3500 +25%, -30% |
| 5978011101 | 73.65 \pm 1.50 2.900 | 38.85 \pm 0.75 1.530 | 12.70 \pm 0.40 0.500 | 188.00 | 7.80 | 16.70 | 2.15 | 35.90 | 3740 \pm 25% |
| 5978015901 | 100.00 \pm 2.00 3.937 | 55.00 \pm 1.20 2.165 | 12.70 \pm 0.30 0.500 | 320.00 | 8.30 | 23.00 | 2.77 | 63.70 | 3500 \pm 25% |
| 5978008001 | 154.20 \pm 3.81 6.070 | 69.40 \pm 1.73 2.732 | 19.05 \pm 0.50 0.750 | 1240.00 | 4.10 | 31.30 | 7.60 | 237.00 | 7000 \pm 25% |
| 5978014001 | 101.60 \pm 2.10 4.000 | 75.20 \pm 1.50 2.961 | 24.75 \pm 0.55 0.974 | 425.00 | 8.40 | 27.40 | 3.24 | 88.70 | 3425 \pm 25% |

High Permeability, 75 ($\mu_i=5000$) material

| Part Number | A | B | C | Wt. (g) | $\sum lA(\text{cm}^2)$ | $l_e(\text{cm})$ | $A_e(\text{cm}^2)$ | $V_e(\text{cm}^3)$ | $A_L(\text{nH})$ |
|-------------|--------------------------|--------------------------|---------------------|---------|------------------------|------------------|--------------------|--------------------|------------------|
| 5975000801 | 3.95 \pm 0.15 0.155 | 2.15 \pm 0.15 0.088 | 1.40 -0.25 0.050 | 0.05 | 87.60 | 0.92 | 0.011 | 0.0097 | 585 \pm 20% |
| 5975002101 | 4.95 -0.25 0.190 | 2.20 \pm 0.15 0.090 | 1.40 -0.25 0.050 | 0.09 | 69.20 | 1.04 | 0.015 | 0.0157 | 770 \pm 20% |
| 5975000101 | 5.95 -0.25 0.230 | 3.05 \pm 0.10 0.120 | 1.65 -0.25 0.060 | 0.14 | 63.80 | 1.30 | 0.02 | 0.027 | 785 \pm 20% |
| 5975000201 | 9.50 \pm 0.20 0.375 | 4.75 \pm 0.15 0.187 | 3.30 -0.25 0.125 | 0.83 | 28.60 | 2.07 | 0.072 | 0.15 | 2200 \pm 20% |

High Permeability, 75 ($\mu_i=5000$) material

| Part Number | A | B | C | Wt. (g) | $\sum l/A(\text{cm}^{-1})$ | $l_e(\text{cm})$ | $A_e(\text{cm}^2)$ | $V_e(\text{cm}^3)$ | $A_L(\text{nH})$ |
|-------------|------------------------|------------------------|------------------------|---------|----------------------------|------------------|--------------------|--------------------|--------------------|
| 5975000211 | 9.74 Max 0.383 Max | 4.56 Min 0.180 Min | 3.34 Max 0.132 Max | 0.83 | 28.60 | 2.07 | 0.072 | 0.15 | 2200 ±20% |
| 5975000221 | 10.20 Max 0.401 Max | 4.10 Min 0.162 Min | 3.80 Max 0.149 Max | 0.83 | 28.60 | 2.07 | 0.072 | 0.15 | 2200 +20%, -25% |
| 5975000301 | 12.70 ±0.25 0.500 | 7.15 ±0.20 0.281 | 4.90 -0.25 0.188 | 2.00 | 22.90 | 2.95 | 0.129 | 0.38 | 2725 ±20% |
| 5975000321 | 13.45 Max 0.529 Max | 6.45 Min 0.254 Min | 5.40 Max 0.212 Max | 2.00 | 22.90 | 2.95 | 0.129 | 0.38 | 2725 +20%, -25% |
| 5975001101 | 12.70 ±0.25 0.500 | 7.90 ±0.20 0.312 | 6.35 ±0.25 0.250 | 2.40 | 20.80 | 3.12 | 0.15 | 0.47 | 3000 ±20% |
| 5975001121 | 13.45 Max 0.529 Max | 7.20 Min 0.284 Min | 7.10 Max 0.280 Max | 2.40 | 20.80 | 3.12 | 0.15 | 0.47 | 3000 +20%, -25% |
| 5975001901 | 12.70 ±0.25 0.500 | 7.90 ±0.20 0.312 | 12.70 ±0.35 0.500 | 4.70 | 10.40 | 3.12 | 0.299 | 0.93 | 6000 ±20% |
| 5975005101 | 16.00 ±0.40 0.630 | 9.60 ±0.30 0.378 | 4.75 -0.25 0.182 | 2.80 | 26.60 | 3.85 | 0.145 | 0.56 | 2350 ±20% |
| 5975004901 | 16.00 ±0.40 0.630 | 9.60 ±0.30 0.378 | 6.35 ±0.25 0.250 | 4.00 | 19.40 | 3.85 | 0.199 | 0.77 | 3225 ±20% |
| 5975004921 | 16.90 Max 0.665 Max | 8.80 Min 0.347 Min | 7.10 Max 0.280 Max | 4.00 | 19.40 | 3.85 | 0.199 | 0.77 | 3225 +20%, -25% |
| 5975000601 | 21.00 ±0.35 0.825 | 13.20 ±0.30 0.520 | 6.35 ±0.25 0.250 | 6.40 | 21.30 | 5.20 | 0.243 | 1.26 | 2950 ±20% |
| 5975000621 | 21.85 Max 0.860 Max | 12.40 Min 0.489 Min | 7.10 Max 0.280 Max | 6.40 | 21.30 | 5.20 | 0.243 | 1.26 | 2950 +20%, -25% |
| 5975000501 | 21.00 ±0.35 0.825 | 13.20 ±0.30 0.520 | 11.90 ±0.40 0.468 | 12.00 | 11.40 | 5.20 | 0.46 | 2.36 | 5500 ±20% |
| 5975001801 | 22.10 ±0.40 0.870 | 13.70 ±0.30 0.540 | 6.35 ±0.25 0.250 | 7.20 | 20.70 | 5.40 | 0.262 | 1.42 | 3025 ±20% |
| 5975001821 | 23.00 Max 0.905 Max | 12.90 Min 0.508 Min | 7.10 Max 0.280 Max | 7.20 | 20.70 | 5.40 | 0.262 | 1.42 | 3025 +20%, -25% |
| 5975007601 | 22.10 ±0.40 0.870 | 13.70 ±0.30 0.540 | 12.70 ±0.45 0.500 | 15.00 | 10.30 | 5.40 | 0.52 | 2.83 | 6100 ±20% |
| 5975007621 | 23.00 Max 0.905 Max | 12.90 Min 0.508 Min | 13.65 Max 0.537 Max | 15.00 | 10.30 | 5.40 | 0.52 | 2.83 | 6100 +20%, -25% |
| 5975001401 | 25.40 ±0.60 1.000 | 15.50 ±0.50 0.610 | 8.15 ±0.30 0.320 | 12.00 | 15.10 | 6.20 | 0.41 | 2.52 | 4000 ±20% |
| 5975006401 | 25.40 ±0.60 1.000 | 15.50 ±0.50 0.610 | 12.70 ±0.50 0.500 | 19.00 | 10.00 | 6.20 | 0.62 | 3.80 | 6250 ±20% |
| 5975002701 | 35.55 ±0.75 1.400 | 23.00 ±0.55 0.900 | 12.70 ±0.50 0.500 | 33.00 | 11.20 | 8.90 | 0.79 | 7.00 | 5500 ±25% |
| 5975021921 | 50.40 Max 1.984 Max | 32.50 Min 1.278 Min | 16.85 Max 0.663 Max | 76.00 | 10.59 | 12.70 | 1.20 | 15.30 | 6500 +25%, -30% |
| 5975022021 | 50.40 Max 1.984 Max | 32.50 Min 1.278 Min | 20.00 Max 0.787 Max | 91.00 | 8.86 | 12.70 | 1.44 | 18.27 | 7770 +25%, -30% |
| 5975003801 | 61.00 ±1.30 2.400 | 35.55 ±0.85 1.400 | 12.70 ±0.50 0.500 | 106.00 | 9.20 | 14.50 | 1.58 | 22.80 | 6850 ±25% |
| 5975003821 | 62.80 Max 2.472 Max | 34.20 Min 1.347 Min | 13.70 Max 0.539 Max | 106.00 | 9.20 | 14.50 | 1.58 | 22.80 | 6850 +25%, -30% |
| 5975011101 | 73.65 ±1.50 2.900 | 38.85 ±0.75 1.530 | 12.70 ±0.40 0.500 | 188.00 | 7.80 | 16.70 | 2.15 | 35.90 | 8100 ±25% |
| 5975011121 | 75.65 Max 2.978 Max | 37.60 Min 1.481 Min | 13.60 Max 0.535 Max | 188.00 | 7.80 | 16.70 | 2.15 | 35.90 | 8100 +25%, -30% |

Quick Link: www.fair-rite.com/tor

High Permeability, 76 ($\mu_i=10,000$) material

| Part Number | A | B | C | Wt. (g) | $\sum lA(\text{cm}^{-1})$ | $l_e(\text{cm})$ | $A_e(\text{cm}^2)$ | $V_e(\text{cm}^3)$ | $A_L(\text{nH})$ |
|-------------|------------------------|------------------------|------------------------|---------|---------------------------|------------------|--------------------|--------------------|--------------------|
| 5976000801 | 3.95 ±0.15 0.155 | 2.15 +0.15 0.088 | 1.40 -0.25 0.050 | 0.05 | 87.60 | 0.92 | 0.011 | 0.0097 | 1430 ±30% |
| 5976000101 | 5.95 -0.25 0.230 | 3.05 ±0.10 0.120 | 1.65 -0.25 0.060 | 0.14 | 63.80 | 1.30 | 0.02 | 0.027 | 1950 ±30% |
| 5976000201 | 9.50 ±0.20 0.375 | 4.75 ±0.15 0.187 | 3.30 -0.25 0.125 | 0.83 | 28.60 | 2.07 | 0.072 | 0.15 | 4400 ±30% |
| 5976000211 | 9.74 Max 0.383 Max | 4.56 Min 0.180 Min | 3.34 Max 0.132 Max | 0.83 | 28.60 | 2.07 | 0.072 | 0.15 | 4400 ±30% |
| 5976000221 | 10.20 Max 0.401 Max | 4.10 Min 0.162 Min | 3.80 Max 0.149 Max | 0.83 | 28.60 | 2.07 | 0.072 | 0.15 | 4400 +30%, -35% |
| 5976022121 | 30.10 Max 1.185 Max | 17.90 Min 0.705 Min | 16.00 Max 0.629 Max | 27.50 | 9.78 | 7.32 | 0.749 | 5.48 | 12800 ±30% |
| 5976022021 | 50.40 Max 1.984 Max | 32.50 Min 1.278 Min | 20.00 Max 0.787 Max | 91.00 | 8.86 | 12.70 | 1.44 | 18.27 | 14200 ±30% |
| 5976011121 | 75.65 Max 2.978 Max | 37.60 Min 1.481 Min | 13.60 Max 0.535 Max | 188.00 | 7.80 | 16.50 | 2.14 | 35.30 | 16000 ±30% |

Quick Link: www.fair-rite.com/planar

EE14/7, EE18/8, EE22/11, EE32/13, EE38/16, EE43/19, EE64/21
 EI 14/5, EI 18/6, EI 22/7, EI 32/10, E 64/15
 ER9.5, ER11, ER14.5

Planar EE and EI cores, with their low profile are suitable for board level installation allowing assembly without the need for plastic coilformers and can also allow windings integrated into multi-level PCBs. Planar ER cores with their low mass and low profile are suitable for Surface Mount installations in low power filter and transformer applications.

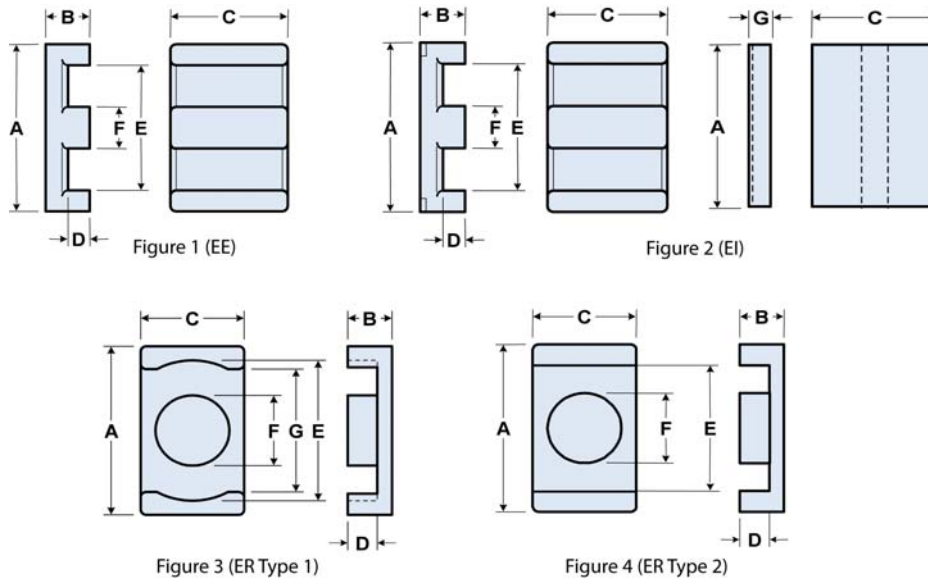

- Planar EE, ER and EI cores can be supplied with the center post gapped to a mechanical dimension, or an A_L value.
- A_L value is measured at 1 kHz, $B < 10$ gauss.
- Weight indicated is per pair or set.

Quick Link: www.fair-rite.com/planar

Legend: Symbols & Definition

Dimensions (Top numbers are in millimeters, bottom numbers are in nominal inches.)

$\Sigma\ell/A$: Core Constant, ℓ_e : Effective Path Length, A_e : Effective Cross-Sectional Area, V_e : Effective Core Volume, A_L : Inductance Factor ($\frac{L}{N^2}$)

Explanation of part numbers: Digits 1 & 2 = product class, 3 & 4 = material grade.

Dimensions

| Row # | Part Number | Fig. | Generic Size | A | B | C | D | E | F | G | Wt. (g) per Set |
|-------|--|------|--------------|-----------------------|-----------------------|-----------------------|-----------------------|------------------------|----------------------|-----------------------|-----------------|
| (1) | 9478201002 9498201002 9495201002 | 1 | EE14/7 | 14.00 ± 0.3 0.551 | 3.50 ± 0.1 0.138 | 5.00 ± 0.15 0.197 | 1.90 min 0.075 min | 10.52 min 0.414 min | 3.00 ± 0.3 0.118 | | 1.20 |
| (2) | 9478202002 9498202002 9495202002 | 1 | EE18/8 | 18.00 ± 0.4 0.709 | 4.00 ± 0.1 0.157 | 10.00 ± 0.2 0.394 | 1.80 min 0.071 min | 13.70 min 0.539 min | 4.00 ± 0.1 0.157 | | 4.80 |
| (3) | 9478203002 9498203002 9495203002 | 1 | EE22/11 | 21.80 ± 0.4 0.858 | 5.70 ± 0.2 0.224 | 15.80 ± 0.35 0.622 | 3.20 ± 0.2 0.126 | 16.80 ± 0.4 0.661 | 5.00 ± 0.2 0.197 | | 13.00 |
| (4) | 9478204002 9498204002 9495204002 | 1 | EE32/13 | 31.75 ± 0.65 1.250 | 6.35 ± 0.2 0.250 | 20.35 ± 0.45 0.801 | 3.18 ± 0.2 0.125 | 24.50 min 0.965 min | 6.35 ± 0.15 0.250 | | 26.00 |
| (5) | 9478205002 9498205002 9495205002 | 1 | EE38/16 | 38.10 ± 0.8 1.500 | 8.25 ± 0.25 0.325 | 25.40 ± 0.5 1.000 | 4.45 ± 0.25 0.175 | 30.23 min 1.190 min | 7.60 ± 0.2 0.299 | | 50.00 |
| (6) | 9478206002 9498206002 9495206002 | 1 | EE43/19 | 43.20 ± 0.6 1.701 | 9.55 ± 0.3 0.376 | 27.90 ± 0.4 1.098 | 5.70 ± 0.3 0.224 | 34.40 min 1.354 min | 8.15 ± 0.3 0.321 | | 70.00 |
| (7) | 9478207002 9498207002 9495207002 | 1 | EE64/21 | 64.00 ± 1 2.520 | 10.35 ± 0.15 0.407 | 51.00 ± 0.8 2.008 | 5.30 ± 0.25 0.209 | 53.80 ± 1 2.118 | 10.30 ± 0.2 0.406 | | 200.00 |
| (8) | 7878400121 7898400121 7895400121 | 2 | EI 14/5 | 14.00 ± 0.3 0.551 | 3.50 ± 0.1 0.138 | 5.00 ± 0.15 0.197 | 1.90 min 0.075 min | 10.52 min 0.414 min | 3.00 ± 0.1 0.118 | 1.80 ± 0.1 0.071 | 1.10 |
| (9) | 7878400221 7898400221 7895400221 | 2 | EI 18/6 | 18.00 ± 0.35 0.709 | 4.00 ± 0.15 0.157 | 10.00 ± 0.3 0.394 | 1.80 min 0.071 min | 13.70 min 0.539 min | 4.00 ± 0.2 0.157 | 2.40 ± 0.15 0.094 | 4.10 |
| (10) | 7878400321 7898400321 7895400321 | 2 | EI 22/8 | 21.80 ± 0.4 0.858 | 5.70 ± 0.15 0.224 | 15.80 ± 0.35 0.622 | 3.20 ± 0.15 0.126 | 16.80 ± 0.4 0.661 | 5.00 ± 0.2 0.197 | 2.50 ± 0.15 0.098 | 10.50 |
| (11) | 7878400421 7898400421 7895400421 | 2 | EI 32/10 | 31.75 ± 0.5 1.250 | 6.35 ± 0.15 0.250 | 20.32 ± 0.4 0.800 | 3.18 ± 0.15 0.125 | 24.50 min 0.965 min | 6.35 ± 0.2 0.250 | 3.18 ± 0.15 0.125 | 24.00 |
| (12) | 7878400721 7898400721 7895400721 | 2 | EI 64/15 | 64.00 ± 1 2.520 | 10.35 ± 0.15 0.407 | 51.00 ± 0.8 2.008 | 5.30 ± 0.25 0.209 | 53.80 ± 1 2.118 | 10.30 ± 0.2 0.406 | 5.08 ± 0.2 0.200 | 178.00 |
| (13) | 9578100502 9598100502 9595100502 | 3 | ER9.5 | 9.35 ± 0.3 0.368 | 2.45 ± 0.15 0.096 | 4.90 ± 0.2 0.193 | 1.68 ± 0.11 0.066 | 7.65 ± 0.3 0.301 | 3.40 ± 0.15 0.134 | 7.00 min 0.276 min | 0.70 |
| (14) | 9578110502 9598110502 9595110502 | 3 | ER11 | 10.80 ± 0.3 0.425 | 2.45 ± 0.15 0.096 | 5.90 ± 0.2 0.232 | 1.58 ± 0.16 0.062 | 8.85 ± 0.3 0.348 | 4.15 ± 0.2 0.163 | 7.90 min 0.312 min | 1.00 |
| (15) | 9578150602 9598150602 9595150602 | 4 | ER14.5 | 14.50 ± 0.2 0.571 | 2.95 ± 0.1 0.116 | 6.70 ± 0.1 0.264 | 1.65 ± 0.1 0.065 | 11.80 ± 0.2 0.465 | 4.70 ± 0.1 0.185 | n/a n/a | 1.80 |

Quick Link: www.fair-rite.com/planar

Magnetic Core Parameters

Table Continued ...

| Row # | Part Number | $\sum \ell A (\text{cm}^{-1})$ | $\ell_e (\text{cm})$ | $A_e (\text{cm}^2)$ | $V_e (\text{cm}^3)$ | $A_{\min} (\text{cm}^2)$ | $A_L (\text{nH})$ |
|-------|--|--------------------------------|----------------------|---------------------|---------------------|--------------------------|--|
| (1) | 9478201002 9498201002 9495201002 | 13.40 | 2.01 | 0.153 | 0.315 | 0.15 | 1050 ±25% 1100 ±25% 1300 ±25% |
| (2) | 9478202002 9498202002 9495202002 | 6.00 | 2.43 | 0.395 | 0.96 | 0.39 | 2600 ±25% 2700 ±25% 3300 ±25% |
| (3) | 9478203002 9498203002 9495203002 | 4.10 | 3.24 | 0.79 | 2.56 | 0.79 | 4500 ±25% 4600 ±25% 5500 ±25% |
| (4) | 9478204002 9498204002 9495204002 | 3.20 | 4.17 | 1.29 | 5.38 | 1.27 | 6200 ±25% 6400 ±25% 7600 ±25% |
| (5) | 9478205002 9498205002 9495205002 | 3.00 | 5.29 | 1.90 | 10.10 | 1.80 | 8200 ±25% 8800 ±25% 10100 ±25% |
| (6) | 9478206002 9498206002 9495206002 | 2.80 | 6.21 | 2.21 | 13.70 | 2.15 | 7300 ±25% 7200 ±25% 9500 ±25% |
| (7) | 9478207002 9498207002 9495207002 | 1.54 | 8.07 | 5.20 | 41.50 | 5.15 | 14800 ±25% 14800 ±25% 18000 ±25% |
| (8) | 7878400121 7898400121 7895400121 | 10.90 | 1.66 | 0.152 | 0.252 | 0.15 | 1440 ±25% 1440 ±25% 1600 ±25% |
| (9) | 7878400221 7898400221 7895400221 | 4.90 | 2.05 | 0.421 | 0.863 | 0.40 | 3200 ±25% 3300 ±25% 3800 ±25% |
| (10) | 7878400321 7898400321 7895400321 | 3.30 | 2.61 | 0.79 | 2.06 | 0.79 | 5400 ±25% 5500 ±25% 6200 ±25% |
| (11) | 7878400421 7898400421 7895400421 | 2.70 | 3.52 | 1.30 | 4.57 | 1.29 | 7200 ±25% 7300 ±25% 8700 ±25% |
| (12) | 7878400721 7898400721 7895400721 | 1.40 | 7.00 | 5.18 | 36.30 | 5.15 | 16900 ±25% 18000 ±25% 22200 ±25% |
| (13) | 9578100502 9598100502 9595100502 | 15.20 | 1.361 | 0.0893 | 0.122 | 0.076 | 900 ±25% 900 ±25% 950 ±25% |
| (14) | 9578110502 9598110502 9595110502 | 11.20 | 1.40 | 0.126 | 0.177 | 0.103 | 1200 ±25% 1250 ±25% 1350 ±25% |
| (15) | 9578150602 9598150602 9595150602 | 10.80 | 1.90 | 0.176 | 0.333 | 0.17 | 1400 ±25% 1430 ±25% 1610 ±25% |

P9/5S, P11/7S, P14/8, P18/11, P22/13, P26/16, P30/19, P36/22

Pot cores have found application in all types of inductive devices. The core configuration provides a high degree of self-shielding. It also facilitates gapping to enhance utility for a variety of magnetic designs.

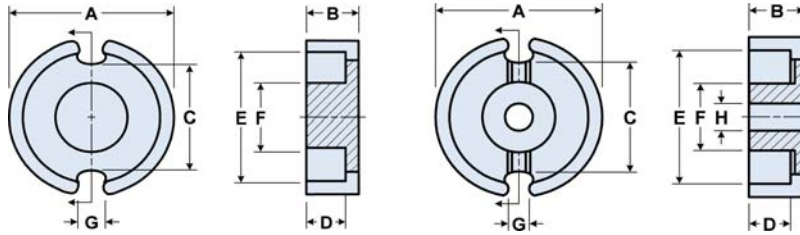

Figure 1

Figure 2

- Pot cores can be supplied with the center post gapped to a mechanical dimension or an A_L value.
- A_L value is measured at 1 kHz, $B < 10$ gauss.
- Weight indicated is per pair or set.

Legend: Symbols & Definition

Dimensions (Top numbers are in millimeters, bottom numbers are in nominal inches.)

$\Sigma \ell/A$: Core Constant, ℓ_e : Effective Path Length, A_e : Effective Cross-Sectional Area, V_e : Effective Core Volume, A_L : Inductance Factor ($\frac{L}{N^2}$)

Explanation of part numbers: Digits 1 & 2 = product class, 3 & 4 = material grade.

Dimensions

| Row # | Part Number | Fig. | Generic Size | A | B | C | D | E | F | G | H | Wt. (g) per Set |
|-------|--|------|--------------|---------------------|---------------------|------------------------|-----------------------|------------------------|---------------------|-----------------------|---------------------|-----------------|
| (1) | 5678090621 5698090621 5695090621 | 1 | P9/5S | 9.15 ±0.15 0.360 | 2.65 ±0.1 0.104 | 5.65 ±0.15 0.222 | 1.80 min 0.071 min | 7.50 min 0.295 min | 3.80 ±0.1 0.150 | 2.10 ±0.3 0.083 | | 1.00 |
| (2) | 5678110821 5698110821 5695110821 | 1 | P11/7S | 11.10 ±0.2 0.437 | 3.30 ±0.1 0.130 | 6.80 ±0.25 0.268 | 2.30 ±0.15 0.091 | 9.20 ±0.2 0.362 | 4.60 ±0.1 0.181 | 2.20 ±0.3 0.087 | | 1.90 |
| (3) | 5678140921 5698140921 5695140921 | 2 | P14/8 | 14.00 ±0.3 0.551 | 4.20 ±0.2 0.165 | 9.55 ±0.3 0.376 | 3.10 ±0.2 0.122 | 11.80 ±0.4 0.465 | 5.90 ±0.2 0.232 | 3.30 ±0.6 0.130 | 2.90 ±0.3 0.114 | 3.20 |
| (4) | 5678181221 5698181221 5695181221 | 2 | P18/11 | 18.00 ±0.4 0.709 | 5.35 ±0.15 0.211 | 13.40 ±0.4 0.528 | 3.80 ±0.2 0.150 | 14.90 min 0.587 min | 7.45 ±0.15 0.293 | 4.00 ±0.3 0.157 | 3.20 ±0.2 0.126 | 6.00 |
| (5) | 5678221421 5698221421 5695221421 | 2 | P22/13 | 21.60 ±0.4 0.850 | 6.70 ±0.1 0.264 | 14.90 ±1.6 0.587 | 4.70 ±0.15 0.185 | 18.20 ±0.4 0.717 | 9.25 ±0.15 0.364 | 3.70 ±0.7 0.146 | 4.55 ±0.15 0.179 | 12.00 |
| (6) | 5678261721 5698261721 5695261721 | 2 | P26/16 | 25.50 ±0.5 1.004 | 8.05 ±0.15 0.317 | 17.20 ±0.5 0.677 | 5.65 ±0.2 0.222 | 21.60 ±0.4 0.850 | 11.10 ±0.3 0.437 | 4.15 ±0.5 0.163 | 5.40 ±0.25 0.213 | 20.00 |
| (7) | 5678302021 5698302021 5695302021 | 2 | P30/19 | 30.00 ±0.5 1.181 | 9.40 ±0.2 0.370 | 20.60 min 0.811 min | 6.60 ±0.2 0.260 | 25.00 min 0.984 min | 13.30 ±0.2 0.524 | 3.68 min 0.145 min | 5.60 ±0.2 0.220 | 34.00 |
| (8) | 5678362321 5698362321 5695362321 | 2 | P36/22 | 35.60 ±0.6 1.402 | 10.90 ±0.2 0.429 | 26.20 ±0.6 1.031 | 7.60 ±0.3 0.299 | 29.50 min 1.161 min | 15.90 ±0.3 0.626 | 5.15 ±0.4 0.203 | 5.45 ±0.25 0.215 | 54.00 |

Quick Link: www.fair-rite.com/pc

Magnetic Core Parameters

Table Continued ...

| Row # | Part Number | $\sum lA(\text{cm}^{-1})$ | $l_e(\text{cm})$ | $A_e(\text{cm}^2)$ | $V_e(\text{cm}^3)$ | $A_{\min}(\text{cm}^2)$ | $A_L(\text{nH})$ |
|-------|--|---------------------------|------------------|--------------------|--------------------|-------------------------|--------------------------------------|
| (1) | 5678090621 5698090621 5695090621 | 12.00 | 1.35 | 0.112 | 0.152 | 0.09 | 1300 ±25% 1250 ±25% 1400 ±25% |
| (2) | 5678110821 5698110821 5695110821 | 9.50 | 1.65 | 0.173 | 0.284 | 0.145 | 1680 ±25% 1750 ±25% 1900 ±25% |
| (3) | 5678140921 5698140921 5695140921 | 7.90 | 1.98 | 0.251 | 0.495 | 0.198 | 1950 ±25% 1950 ±25% 2100 ±25% |
| (4) | 5678181221 5698181221 5695181221 | 6.00 | 2.59 | 0.43 | 1.12 | 0.36 | 2600 ±25% 2700 ±25% 3400 ±25% |
| (5) | 5678221421 5698221421 5695221421 | 4.80 | 3.12 | 0.648 | 2.00 | 0.51 | 4000 ±25% 4100 ±25% 5000 ±25% |
| (6) | 5678261721 5698261721 5695261721 | 4.40 | 3.80 | 0.867 | 3.31 | 0.74 | 4800 ±25% 5000 ±25% 5500 ±25% |
| (7) | 5678302021 5698302021 5695302021 | 3.56 | 4.53 | 1.27 | 5.75 | 1.14 | 5700 ±25% 5800 ±25% 7500 ±25% |
| (8) | 5678362321 5698362321 5695362321 | 2.90 | 5.53 | 1.84 | 9.78 | 1.64 | 8300 ±25% 8500 ±25% 10000 ±25% |

RM4, RM5, RM6, RM8, RM10, RM12, RM14

RM (Rectangular Modulus) cores allow better shielding than E type geometries while also providing easier winding accessibility and better power dissipation than a pot core configuration. Fair-Rite's standard RM cores all have a solid center post and standard height, low profile and alternate materials are available upon request.

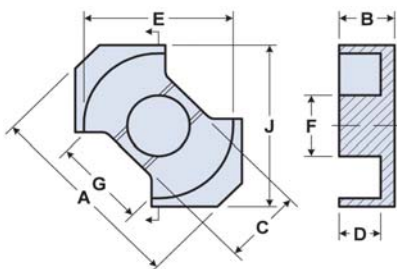

Figure 1

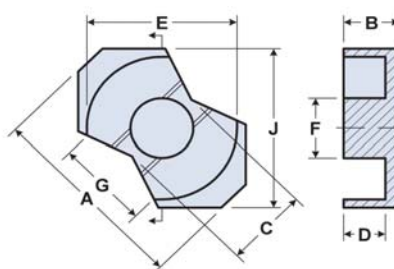

Figure 2

- RM cores can be supplied with the center post gapped to a mechanical dimension or an A_L value.
- A_L value is measured at 1 kHz, $B < 10$ gauss.
- Weight indicated is per pair or set.

Legend: Symbols & Definition

Dimensions (Top numbers are in millimeters, bottom numbers are in nominal inches.)

$\Sigma \ell/A$: Core Constant, ℓ_e : Effective Path Length, A_e : Effective Cross-Sectional Area, V_e : Effective Core Volume, A_L : Inductance Factor ($\frac{L}{N^2}$)

Explanation of part numbers: Digits 1 & 2 = product class, 3 & 4 = material grade.

Dimensions

| Row # | Part Number | Fig. | Generic Size | A | B | C | D | E | F | G | J | Wt. (g) per Set |
|-------|--|------|--------------|-----------------------|-----------------------|-----------------------|----------------------|-----------------------|-----------------------|------------------------|--------------------------|-----------------|
| (1) | 6278110121 6298110121 6295110121 | 1 | RM4 | 10.75 ± 0.25 0.423 | 5.25 ± 0.1 0.207 | 4.50 ± 0.1 0.177 | 3.65 ± 0.15 0.144 | 8.15 ± 0.2 0.321 | 3.80 ± 0.1 0.150 | 5.80 min 0.228 min | 9.60 ± 0.2 0.378 | 1.70 |
| (2) | 6278140121 6298140121 6295140121 | 1 | RM5 | 14.30 ± 0.3 0.563 | 5.20 ± 0.1 0.205 | 6.60 ± 0.2 0.260 | 3.25 ± 0.15 0.128 | 10.40 ± 0.2 0.409 | 4.80 ± 0.1 0.189 | 6.00 min 0.236 min | 12.05 ± 0.25 0.474 | 3.20 |
| (3) | 6278180121 6298180121 6295180121 | 2 | RM6 | 17.60 ± 0.3 0.693 | 6.20 ± 0.1 0.244 | 7.90 ± 0.3 0.311 | 4.25 ± 0.15 0.167 | 12.65 ± 0.25 0.498 | 6.25 ± 0.15 0.246 | 8.40 min 0.331 min | 14.40 ± 0.3 0.567 | 5.50 |
| (4) | 6278230121 6298230121 6295230121 | 1 | RM8 | 22.75 ± 0.45 0.896 | 8.20 ± 0.1 0.323 | 10.80 ± 0.2 0.425 | 5.50 ± 0.15 0.217 | 17.30 ± 0.3 0.681 | 8.40 ± 0.15 0.331 | 9.80 min 0.386 min | 19.10 ± 0.4 0.752 | 13.00 |
| (5) | 6278280121 6298280121 6295280121 | 1 | RM10 | 27.80 ± 0.6 1.094 | 9.30 ± 0.15 0.366 | 13.25 ± 0.25 0.522 | 6.40 ± 0.2 0.252 | 21.65 ± 0.45 0.852 | 10.65 ± 0.2 0.419 | 12.50 min 0.492 min | 24.15 ± 0.55 0.951 | 22.00 |
| (6) | 6278370121 6298370121 6295370121 | 1 | RM12 | 36.75 ± 0.75 1.447 | 12.25 ± 0.15 0.482 | 15.85 ± 0.25 0.624 | 8.55 ± 0.2 0.337 | 25.45 ± 0.55 1.002 | 12.60 ± 0.2 0.496 | 13.40 min 0.528 min | 29.20 ± 0.6 1.150 | 46.00 |
| (7) | 6278420121 6298420121 6295420121 | 1 | RM14 | 41.60 ± 0.6 1.638 | 15.05 ± 0.1 0.593 | 18.70 ± 0.3 0.736 | 10.55 ± 0.2 0.415 | 29.50 ± 0.5 1.161 | 14.75 ± 0.25 0.581 | 17.00 min 0.669 min | 34.15 ± 0.65 1.344 | 69.00 |

Magnetic Core Parameters

Table Continued ...

| Row # | Part Number | $\sum lA(\text{cm}^{-1})$ | $l_e(\text{cm})$ | $A_e(\text{cm}^2)$ | $V_e(\text{cm}^3)$ | $A_{\min}(\text{cm}^2)$ | $A_L(\text{nH})$ |
|-------|--|---------------------------|------------------|--------------------|--------------------|-------------------------|-------------------------------------|
| (1) | 6278110121 6298110121 6295110121 | 17.60 | 2.38 | 0.134 | 0.319 | 0.113 | 900 ±25% 1020 ±25% 1130 ±25% |
| (2) | 6278140121 6298140121 6295140121 | 10.30 | 2.39 | 0.233 | 0.555 | 0.181 | 1650 ±25% 1770 ±25% 2100 ±25% |
| (3) | 6278180121 6298180121 6295180121 | 9.30 | 3.10 | 0.342 | 1.06 | 0.312 | 2000 ±25% 2470 ±25% 2600 ±25% |
| (4) | 6278230121 6298230121 6295230121 | 6.70 | 4.03 | 0.60 | 2.419 | 0.554 | 3000 ±25% 3100 ±25% 3500 ±25% |
| (5) | 6278280121 6298280121 6295280121 | 5.30 | 4.79 | 0.898 | 4.306 | 0.884 | 4200 ±25% 4300 ±25% 4900 ±25% |
| (6) | 6278370121 6298370121 6295370121 | 4.30 | 6.13 | 1.41 | 8.675 | 1.247 | 5400 ±25% 5500 ±25% 6360 ±25% |
| (7) | 6278420121 6298420121 6295420121 | 3.80 | 7.38 | 1.95 | 14.37 | 1.709 | 6200 ±25% 6200 ±25% 7500 ±25% |

Quick Link: www.fair-rite.com/pq

PQ20/16, PQ20/20, PQ26/20, PQ26/25, PQ32/20, PQ32/30, PQ35/35, PQ40/40, PQ50/50

PQ cores were developed for use in power applications. The large surface area to volume of the core aids in heat dissipation. PQ cores are employed both in filter and transformer designs for switch mode power supplies.

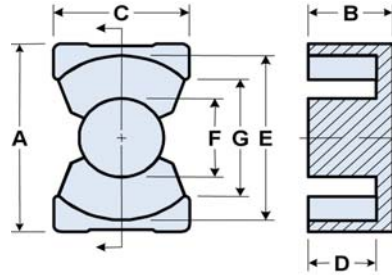

- PQ cores can be supplied with the centerpost gapped to a mechanical dimension or an A_L value.
- A_L value is measured at 1 kHz, $B < 10$ gauss.
- Weight indicated is per pair or set.

Legend: Symbols & Definition

Dimensions (Top numbers are in millimeters, bottom numbers are in nominal inches.)

$\Sigma \ell/A$: Core Constant, ℓ_e : Effective Path Length, A_e : Effective Cross-Sectional Area, V_e : Effective Core Volume, A_L : Inductance Factor ($\frac{L}{N^2}$)

Explanation of part numbers: Digits 1 & 2 = product class, 3 & 4 = material grade.

Dimensions

| Row # | Part Number | Generic Size | A | B | C | D | E | F | G | Wt. (g) per Set |
|-------|--|--------------|----------------------|-----------------------|-----------------------|-----------------------|------------------------|-----------------------|------------------------|-----------------|
| (1) | 6678211621 6698211621 6695211621 | PQ20/16 | 20.50 ± 0.4 0.807 | 8.00 ± 0.15 0.315 | 14.00 ± 0.4 0.551 | 5.00 ± 0.15 0.197 | 18.00 ± 0.4 0.709 | 8.80 ± 0.2 0.346 | 12.00 min 0.472 min | 13.00 |
| (2) | 6678212021 6698212021 6695212021 | PQ20/20 | 20.50 ± 0.4 0.807 | 10.20 ± 0.15 0.402 | 14.00 ± 0.4 0.551 | 7.00 ± 0.15 0.276 | 18.00 ± 0.4 0.709 | 8.80 ± 0.2 0.346 | 12.00 min 0.472 min | 16.00 |
| (3) | 6678272021 6698272021 6695272021 | PQ26/20 | 26.50 ± 0.5 1.043 | 10.10 ± 0.15 0.398 | 19.00 ± 0.4 0.748 | 5.75 ± 0.15 0.226 | 22.50 ± 0.4 0.886 | 12.00 ± 0.3 0.472 | 15.50 min 0.610 min | 30.00 |
| (4) | 6678272521 6698272521 6695272521 | PQ26/25 | 26.50 ± 0.5 1.043 | 12.50 ± 0.15 0.492 | 19.00 ± 0.4 0.748 | 8.05 ± 0.15 0.317 | 22.50 ± 0.4 0.886 | 12.00 ± 0.3 0.472 | 15.50 min 0.610 min | 36.00 |
| (5) | 6678322121 6698322121 6695322121 | PQ32/20 | 32.00 ± 0.6 1.260 | 10.25 ± 0.15 0.404 | 22.00 ± 0.4 0.866 | 5.75 ± 0.15 0.226 | 27.50 ± 0.5 1.083 | 13.45 ± 0.3 0.530 | 19.00 min 0.748 min | 43.00 |
| (6) | 6678323121 6698323121 6695323121 | PQ32/30 | 32.00 ± 0.6 1.260 | 15.15 ± 0.15 0.596 | 22.00 ± 0.4 0.866 | 10.65 ± 0.15 0.419 | 27.50 ± 0.5 1.083 | 13.45 ± 0.3 0.530 | 19.00 min 0.748 min | 57.00 |
| (7) | 6678353621 6698353621 6695353621 | PQ35/35 | 35.10 ± 0.6 1.382 | 17.40 ± 0.2 0.685 | 26.00 ± 0.5 1.024 | 12.50 ± 0.2 0.492 | 32.00 ± 0.5 1.260 | 14.35 ± 0.25 0.565 | 23.50 min 0.925 min | 73.00 |
| (8) | 6678404121 6698404121 6695404121 | PQ40/40 | 40.50 ± 0.9 1.594 | 19.88 ± 0.13 0.783 | 27.93 ± 0.53 1.100 | 14.75 ± 0.15 0.581 | 36.40 min 1.433 min | 14.70 ± 0.30 0.579 | 27.20 min 1.071 min | 97.00 |
| (9) | 6678505021 6698505021 6695505021 | PQ50/50 | 50.00 ± 0.8 1.969 | 25.00 ± 0.15 0.984 | 32.00 ± 0.6 1.260 | 18.10 ± 0.25 0.713 | 44.00 ± 0.7 1.732 | 20.00 ± 0.4 0.787 | 32.00 min 1.260 min | 195.00 |

Magnetic Core Parameters

Table Continued ...

| Row # | Part Number | $\sum lA(\text{cm}^{-1})$ | $l_e(\text{cm})$ | $A_e(\text{cm}^2)$ | $V_e(\text{cm}^3)$ | $A_{\min}(\text{cm}^2)$ | $A_L(\text{nH})$ |
|-------|--|---------------------------|------------------|--------------------|--------------------|-------------------------|-------------------------------------|
| (1) | 6678211621 6698211621 6695211621 | 6.00 | 3.69 | 0.615 | 2.27 | 0.601 | 3430 ±25% 3430 ±25% 3880 ±25% |
| (2) | 6678212021 6698212021 6695212021 | 7.20 | 4.52 | 0.625 | 2.526 | 0.608 | 2920 ±25% 2920 ±25% 3500 ±25% |
| (3) | 6678272021 6698272021 6695272021 | 3.72 | 4.48 | 1.203 | 5.385 | 1.131 | 5510 ±25% 5510 ±25% 6500 ±25% |
| (4) | 6678272521 6698272521 6695272521 | 4.59 | 5.40 | 1.177 | 6.359 | 1.131 | 4670 ±25% 4670 ±25% 6000 ±25% |
| (5) | 6678322121 6698322121 6695322121 | 3.27 | 5.373 | 1.642 | 8.821 | 1.404 | 6000 ±25% 6000 ±25% 7900 ±25% |
| (6) | 6678323121 6698323121 6695323121 | 4.59 | 7.53 | 1.642 | 12.37 | 1.401 | 4500 ±25% 4500 ±25% 6500 ±25% |
| (7) | 6678353621 6698353621 6695353621 | 4.82 | 8.82 | 1.83 | 16.13 | 1.617 | 4900 ±25% 5100 ±25% 6200 ±25% |
| (8) | 6678404121 6698404121 6695404121 | 5.23 | 10.36 | 1.98 | 20.50 | 1.70 | 4300 ±25% 4300 ±25% 5850 ±25% |
| (9) | 6678505021 6698505021 6695505021 | 3.59 | 11.47 | 3.19 | 36.63 | 3.142 | 6720 ±25% 6720 ±25% 8000 ±25% |

EF12.6, EF16, E 187, EF20, EF25, EF32, E33/13, E 375, E42/15, E42/20, E55/21, E65/27

The E core geometry offers an economical design approach for inductive applications in a variety of power designs.

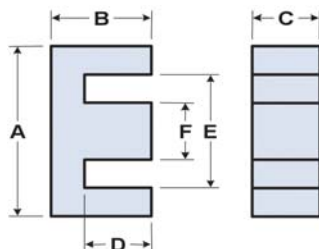

- E cores can be supplied with the center post gapped to a mechanical dimension or an A_L value.
- A_L value is measured at 1 kHz, $B < 10$ gauss.
- Weight indicated is per pair or set.

Legend: Symbols & Definition

Dimensions (Top numbers are in millimeters, bottom numbers are in nominal inches.)

$\Sigma \ell/A$: Core Constant, ℓ_e : Effective Path Length, A_e : Effective Cross-Sectional Area, V_e : Effective Core Volume, A_L : Inductance Factor ($\frac{L}{N^2}$)

Explanation of part numbers: Digits 1 & 2 = product class, 3 & 4 = material grade.

Dimensions

| Row # | Part Number | Generic Size | A | B | C | D | E | F | Wt. (g) per Set |
|-------|--|--------------|----------------------|----------------------|----------------------|----------------------|------------------------|----------------------|-----------------|
| (1) | 9478102002 9498102002 | EF12.6 | 12.70 ±0.35 0.500 | 6.35 ±0.15 0.250 | 3.60 ±0.2 0.142 | 4.65 ±0.15 0.183 | 8.80 min 0.346 min | 3.60 ±0.2 0.142 | 1.80 |
| (2) | 9478101002 9498101002 | EF16 | 16.10 ±0.6 0.634 | 8.05 ±0.2 0.317 | 4.50 ±0.2 0.177 | 5.90 ±0.2 0.232 | 11.30 min 0.445 min | 4.55 ±0.15 0.179 | 4.00 |
| (3) | 9478103002 9498103002 9495103002 | E19/5 | 19.00 ±0.4 0.748 | 8.00 ±0.3 0.315 | 4.80 ±0.3 0.189 | 5.75 ±0.25 0.226 | 13.80 min 0.543 min | 4.50 ±0.3 0.177 | 4.60 |
| (4) | 9478104002 9498104002 | EF20 | 20.00 ±0.6 0.787 | 9.90 ±0.2 0.390 | 5.65 ±0.25 0.222 | 7.20 ±0.2 0.283 | 14.10 min 0.555 min | 5.70 ±0.2 0.224 | 7.40 |
| (5) | 9478105002 9498105002 | EF25 | 25.05 ±0.65 0.986 | 12.55 ±0.25 0.494 | 7.20 ±0.3 0.283 | 8.95 ±0.25 0.352 | 17.50 min 0.689 min | 7.25 ±0.25 0.285 | 16.00 |
| (6) | 9478110002 9498110002 9495110002 | EF32 | 32.10 ±0.6 1.264 | 16.10 ±0.3 0.634 | 9.15 ±0.35 0.360 | 11.50 ±0.3 0.453 | 22.70 min 0.894 min | 9.20 ±0.3 0.362 | 32.00 |
| (7) | 9478111002 9498111002 9495111002 | E33/13 | 33.00 ±0.6 1.299 | 14.00 ±0.3 0.551 | 12.70 ±0.3 0.500 | 9.60 ±0.3 0.378 | 22.80 min 0.898 min | 9.70 ±0.3 0.382 | 40.20 |
| (8) | 9478112002 9498112002 9495112002 | E35/9 | 34.50 ±1 1.358 | 14.35 ±0.35 0.565 | 9.50 ±0.4 0.374 | 9.70 ±0.3 0.382 | 25.40 min 1.000 min | 9.40 ±0.3 0.370 | 29.90 |
| (9) | 9478114002 9498114002 | E42/15 | 42.00 ±0.7 1.654 | 21.20 ±0.3 0.835 | 14.90 ±0.3 0.587 | 15.15 ±0.3 0.596 | 29.50 min 1.161 min | 11.90 ±0.3 0.469 | 88.00 |
| (10) | 9478115002 9498115002 | E42/20 | 42.00 ±0.7 1.654 | 21.20 ±0.3 0.835 | 19.85 ±0.35 0.781 | 15.15 ±0.3 0.596 | 29.50 min 1.161 min | 11.90 ±0.3 0.469 | 112.00 |
| (11) | 9478116002 9498116002 | E55/21 | 55.15 ±1.05 2.171 | 27.50 ±0.3 1.083 | 20.60 ±0.4 0.811 | 18.80 ±0.3 0.740 | 37.50 min 1.476 min | 16.95 ±0.25 0.667 | 216.00 |
| (12) | 9478117002 9498117002 | E65/27 | 65.20 ±1.3 2.567 | 32.50 ±0.3 1.280 | 26.90 ±0.5 1.059 | 22.55 ±0.35 0.888 | 44.20 min 1.740 min | 19.65 ±0.35 0.774 | 410.00 |

Magnetic Core Parameters

Table Continued ...

| Row # | Part Number | $\sum lA(\text{cm}^{-1})$ | $l_e(\text{cm})$ | $A_e(\text{cm}^2)$ | $V_e(\text{cm}^3)$ | $A_{\min}(\text{cm}^2)$ | $A_L(\text{nH})$ |
|-------|--|---------------------------|------------------|--------------------|--------------------|-------------------------|-------------------------------------|
| (1) | 9478102002 9498102002 | 23.40 | 2.96 | 0.127 | 0.376 | 0.122 | 800 ±25% 800 ±25% |
| (2) | 9478101002 9498101002 | 19.30 | 3.77 | 0.196 | 0.739 | 0.189 | 950 ±25% 1000 ±25% |
| (3) | 9478103002 9498103002 9495103002 | 18.10 | 3.99 | 0.22 | 0.878 | 0.216 | 1150 ±25% 1200 ±25% 1400 ±25% |
| (4) | 9478104002 9498104002 | 15.00 | 4.63 | 0.309 | 1.43 | 0.30 | 1400 ±25% 1450 ±25% |
| (5) | 9478105002 9498105002 | 11.40 | 5.79 | 0.509 | 2.95 | 0.49 | 1800 ±25% 1900 ±25% |
| (6) | 9478110002 9498110002 9495110002 | 9.07 | 7.45 | 0.821 | 6.11 | 0.79 | 2600 ±25% 2800 ±25% 3350 ±25% |
| (7) | 9478111002 9498111002 9495111002 | 5.60 | 6.65 | 1.19 | 7.90 | 1.12 | 4000 ±25% 4200 ±25% 5000 ±25% |
| (8) | 9478112002 9498112002 9495112002 | 8.10 | 6.97 | 0.86 | 5.99 | 0.79 | 2800 ±25% 2900 ±25% 3500 ±25% |
| (9) | 9478114002 9498114002 | 5.53 | 9.79 | 1.77 | 17.30 | 1.74 | 4300 ±25% 4600 ±25% |
| (10) | 9478115002 9498115002 | 4.17 | 9.79 | 2.35 | 23.10 | 2.31 | 5200 ±25% 5200 ±25% |
| (11) | 9478116002 9498116002 | 3.50 | 12.40 | 3.49 | 43.10 | 3.42 | 6500 ±25% 6500 ±25% |
| (12) | 9478117002 9498117002 | 2.80 | 14.70 | 5.31 | 78.10 | 5.29 | 7600 ±25% 7900 ±25% |

EFD10, EFD12, EFD15, EFD20, EFD25, EFD30

EFD (Economical Flat Design) cores have been designed to maximize volume in a low profile geometry. EFD cores allow maximum throughput power density with reasonably low mass for board level installation.

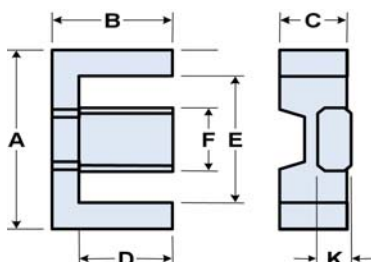

- EFD cores can be supplied with the center post gapped to a mechanical dimension or an A_L value.
- A_L value is measured at 1 kHz, $B < 10$ gauss.
- Weight indicated is per pair or set.

Legend: Symbols & Definition

Dimensions (Top numbers are in millimeters, bottom numbers are in nominal inches.)

$\Sigma \ell/A$: Core Constant, ℓ_e : Effective Path Length, A_e : Effective Cross-Sectional Area, V_e : Effective Core Volume, A_L : Inductance Factor ($\frac{L}{N^2}$)

Explanation of part numbers: Digits 1 & 2 = product class, 3 & 4 = material grade.

Dimensions

| Row # | Part Number | Generic Size | A | B | C | D | E | F | K | Wt. (g) per Set |
|-------|--|--------------|-----------------------|-----------------------|---------------------|----------------------|-----------------------|----------------------|----------------------|-----------------|
| (1) | 8978101021 8998101021 8995101021 | EFD10 | 10.50 ± 0.3 0.413 | 5.20 ± 0.15 0.205 | 2.70 ± 0.2 0.106 | 3.75 ± 0.15 0.148 | 7.65 ± 0.3 0.301 | 4.55 ± 0.2 0.179 | 1.45 ± 0.1 0.057 | 0.90 |
| (2) | 8978121221 8998121221 8995121221 | EFD12 | 12.50 ± 0.35 0.492 | 6.20 ± 0.15 0.244 | 3.50 ± 0.2 0.138 | 4.55 ± 0.15 0.179 | 9.00 ± 0.35 0.354 | 5.40 ± 0.2 0.213 | 2.00 ± 0.1 0.079 | 1.80 |
| (3) | 8978151521 8998151521 8995151521 | EFD15 | 15.00 ± 0.4 0.591 | 7.50 ± 0.15 0.295 | 4.65 ± 0.2 0.183 | 5.50 ± 0.15 0.217 | 11.00 ± 0.4 0.433 | 5.30 ± 0.2 0.209 | 2.40 ± 0.1 0.094 | 2.80 |
| (4) | 8978202021 8998202021 8995202021 | EFD20 | 20.00 ± 0.55 0.787 | 10.00 ± 0.25 0.394 | 6.65 ± 0.2 0.262 | 7.70 ± 0.25 0.303 | 15.40 ± 0.5 0.606 | 8.90 ± 0.3 0.350 | 3.60 ± 0.15 0.142 | 7.00 |
| (5) | 8978252521 8998252521 8995252521 | EFD25 | 25.00 ± 0.5 0.984 | 12.50 ± 0.25 0.492 | 9.10 ± 0.3 0.358 | 9.30 ± 0.25 0.366 | 18.70 ± 0.6 0.736 | 11.40 ± 0.2 0.449 | 5.20 ± 0.2 0.205 | 16.00 |
| (6) | 8978303021 8998303021 8995303021 | EFD30 | 30.00 ± 0.8 1.181 | 15.00 ± 0.25 0.591 | 9.10 ± 0.3 0.358 | 11.20 ± 0.3 0.441 | 22.40 ± 0.75 0.882 | 14.60 ± 0.3 0.575 | 4.90 ± 0.2 0.193 | 24.00 |

Quick Link: www.fair-rite.com/efd

Magnetic Core Parameters

Table Continued ...

| Row # | Part Number | $\sum lA(\text{cm}^{-1})$ | $l_e(\text{cm})$ | $A_e(\text{cm}^2)$ | $V_e(\text{cm}^3)$ | $A_{\min}(\text{cm}^2)$ | $A_L(\text{nH})$ |
|-------|--|---------------------------|------------------|--------------------|--------------------|-------------------------|-------------------------------------|
| (1) | 8978101021 8998101021 8995101021 | 32.70 | 2.36 | 0.072 | 0.171 | 0.066 | 530 ±25% 540 ±25% 610 ±25% |
| (2) | 8978121221 8998121221 8995121221 | 25.90 | 2.84 | 0.11 | 0.311 | 0.108 | 710 ±25% 730 ±25% 850 ±25% |
| (3) | 8978151521 8998151521 8995151521 | 22.30 | 3.44 | 0.154 | 0.531 | 0.127 | 880 ±25% 910 ±25% 1050 ±25% |
| (4) | 8978202021 8998202021 8995202021 | 15.60 | 4.74 | 0.31 | 1.44 | 0.29 | 1200 ±25% 1200 ±25% 1400 ±25% |
| (5) | 8978252521 8998252521 8995252521 | 10.40 | 5.88 | 0.58 | 3.32 | 0.55 | 2200 ±25% 2250 ±25% 2650 ±25% |
| (6) | 8978303021 8998303021 8995303021 | 11.30 | 6.93 | 0.69 | 4.26 | 0.66 | 2800 ±25% 2150 ±25% 2800 ±25% |

ETD29, ETD34, ETD39, ETD44, ETD49, ETD54, ETD59

ETD cores have been designed to make optimum use of a given volume of ferrite material for maximum throughput power, specifically for forward converter transformers. The structure, which includes a round center post, approaches a nearly uniform cross-sectional area throughout the core and provides a winding area that minimizes winding losses. ETD cores are used mainly in switched-mode power supplies and permit off-line designs where IEC and VDE isolation requirements must be met.

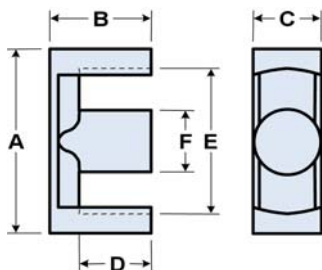

- ETD cores can be supplied with the center post gapped to a mechanical dimension or an A_L value.
- A_L value is measured at 1 kHz, $B < 10$ gauss
- Weight indicated is per pair or set.

Legend: Symbols & Definition

Dimensions (Top numbers are in millimeters, bottom numbers are in nominal inches.)

$\Sigma \ell / A$: Core Constant, ℓ_e : Effective Path Length, A_e : Effective Cross-Sectional Area, V_e : Effective Core Volume, A_L : Inductance Factor ($\frac{L}{N^2}$)

Explanation of part numbers: Digits 1 & 2 = product class, 3 & 4 = material grade.

Dimensions

| Row # | Part Number | Generic Size | A | B | C | D | E | F | Wt. (g) per Set |
|-------|--|------------------|-----------------------|-----------------------|-----------------------|-----------------------|------------------------|-----------------------|-----------------|
| (1) | 9578293202 9598293202 9595293202 | ETD29 | 29.80 ± 0.6 1.173 | 15.80 ± 0.2 0.622 | 9.50 ± 0.3 0.374 | 11.00 ± 0.2 0.433 | 22.00 min 0.866 min | 9.50 ± 0.3 0.374 | 28.00 |
| (2) | 9578343502 9598343502 9595343502 | ETD34 | 34.20 ± 0.65 1.346 | 17.30 ± 0.2 0.681 | 10.80 ± 0.3 0.425 | 12.10 ± 0.2 0.476 | 25.60 min 1.008 min | 10.80 ± 0.3 0.425 | 40.00 |
| (3) | 9578394002 9598394002 9595394002 | ETD39 | 39.10 ± 0.7 1.539 | 19.80 ± 0.2 0.780 | 12.70 ± 0.35 0.500 | 14.60 ± 0.2 0.575 | 29.30 min 1.154 min | 12.70 ± 0.35 0.500 | 60.00 |
| (4) | 9578444502 9598444502 9595444502 | ETD44 | 44.00 ± 0.75 1.732 | 22.30 ± 0.2 0.878 | 14.80 ± 0.35 0.583 | 16.50 ± 0.2 0.650 | 32.50 min 1.280 min | 14.80 ± 0.35 0.583 | 94.00 |
| (5) | 9578494902 9598494902 9595494902 | ETD49 | 49.00 ± 0.8 1.929 | 24.70 ± 0.2 0.972 | 16.30 ± 0.4 0.642 | 18.10 ± 0.2 0.713 | 36.10 min 1.421 min | 16.30 ± 0.4 0.642 | 124.00 |
| (6) | 9578545402 9598545402 9595545402 | ETD54 | 54.20 ± 1 2.134 | 27.10 ± 0.3 1.067 | 18.90 ± 0.4 0.744 | 19.50 ± 0.3 0.768 | 40.50 min 1.594 min | 18.90 ± 0.3 0.744 | 180.00 |
| (7) | 9578606002 9598606002 9595606002 | ETD59 (EER60) | 59.80 ± 1 2.354 | 30.00 ± 0.25 1.181 | 21.70 ± 0.4 0.854 | 22.55 ± 0.25 0.888 | 43.60 min 1.717 min | 21.70 ± 0.4 0.854 | 274.00 |

Quick Link: www.fair-rite.com/etd

Magnetic Core Parameters

Table Continued ...

| Row # | Part Number | $\sum lA(\text{cm}^{-1})$ | $l_e(\text{cm})$ | $A_e(\text{cm}^2)$ | $V_e(\text{cm}^3)$ | $A_{\min}(\text{cm}^2)$ | $A_L(\text{nH})$ |
|-------|--|---------------------------|------------------|--------------------|--------------------|-------------------------|-------------------------------------|
| (1) | 9578293202 9598293202 9595293202 | 9.50 | 7.07 | 0.767 | 5.418 | 0.709 | 2200 ±25% 2200 ±25% 2900 ±25% |
| (2) | 9578343502 9598343502 9595343502 | 8.20 | 7.90 | 0.972 | 7.68 | 0.916 | 2500 ±25% 2600 ±25% 3570 ±25% |
| (3) | 9578394002 9598394002 9595394002 | 7.20 | 9.24 | 1.28 | 11.85 | 1.267 | 3000 ±25% 3000 ±25% 3600 ±25% |
| (4) | 9578444502 9598444502 9595444502 | 6.00 | 10.35 | 1.73 | 17.94 | 1.717 | 3600 ±25% 3800 ±25% 5100 ±25% |
| (5) | 9578494902 9598494902 9595494902 | 5.30 | 11.44 | 2.135 | 24.42 | 2.09 | 4000 ±25% 4000 ±25% 5700 ±25% |
| (6) | 9578545402 9598545402 9595545402 | 4.70 | 12.56 | 2.65 | 33.30 | 2.40 | 5300 ±25% 5400 ±25% 6500 ±25% |
| (7) | 9578606002 9598606002 9595606002 | 3.90 | 13.87 | 3.57 | 49.52 | 3.23 | 6650 ±25% 6950 ±25% 8430 ±25% |

EER25.5/18, EER28/28, EER28/34, EER35/42, EER40/46, EER42/44, EER49/54

EER cores, similar to ETD cores, have been designed to make optimum use of a given volume of ferrite material for maximum throughput power. The structure, which includes a round center post, approaches a nearly uniform cross-sectional area throughout the core and provides a winding area that minimizes winding losses.

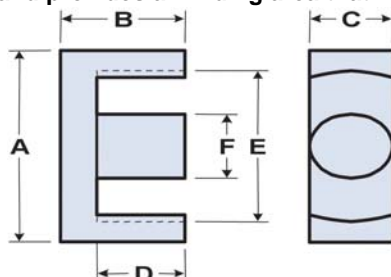

- EER cores can be supplied with the center post gapped to a mechanical dimension or an A_L value.
- A_L value is measured at 1 kHz, $B < 10$ gauss.
- Weight indicated is per pair or set.

Legend: Symbols & Definition

Dimensions (Top numbers are in millimeters, bottom numbers are in nominal inches.)

$\Sigma \ell / A$: Core Constant, ℓ_e : Effective Path Length, A_e : Effective Cross-Sectional Area, V_e : Effective Core Volume, A_L : Inductance Factor ($\frac{\ell}{N^2}$)

Explanation of part numbers: Digits 1 & 2 = product class, 3 & 4 = material grade.

Dimensions

| Row # | Part Number | Generic Size | A | B | C | D | E | F | Wt. (g) per Set |
|-------|--|--------------|-----------------------|----------------------|-----------------------|----------------------|------------------------|-----------------------|-----------------|
| (1) | 9578261802 9598261802 9595261802 | EER25.5 | 25.50 ± 0.5 1.004 | 9.30 ± 0.15 0.366 | 7.50 ± 0.25 0.295 | 6.40 ± 0.15 0.252 | 19.80 min 0.780 min | 7.50 ± 0.25 0.295 | 11.20 |
| (2) | 9578282802 9598282802 9595282802 | EER28/28 | 28.50 ± 0.6 1.122 | 14.00 ± 0.2 0.551 | 11.40 ± 0.3 0.449 | 9.60 ± 0.2 0.378 | 21.20 min 0.835 min | 9.90 ± 0.3 0.390 | 28.00 |
| (3) | 9578283402 9598283402 9595283402 | EER28/34 | 28.50 ± 0.6 1.122 | 16.90 ± 0.2 0.665 | 11.40 ± 0.3 0.449 | 12.50 ± 0.2 0.492 | 21.20 min 0.835 min | 9.90 ± 0.3 0.390 | 32.00 |
| (4) | 9578354202 9598354202 9595354202 | EER35/42 | 35.00 ± 0.65 1.378 | 21.00 ± 0.2 0.827 | 11.30 ± 0.3 0.445 | 15.00 ± 0.2 0.591 | 25.30 min 0.996 min | 11.30 ± 0.3 0.445 | 46.00 |
| (5) | 9578404602 9598404602 9595404602 | EER40/46 | 40.00 ± 0.7 1.575 | 22.90 ± 0.3 0.902 | 13.30 ± 0.3 0.524 | 15.90 ± 0.3 0.626 | 29.50 min 1.161 min | 13.30 ± 0.3 0.524 | 80.00 |
| (6) | 9578424402 9598424402 9595424402 | EER42/44 | 42.00 ± 0.7 1.654 | 22.00 ± 0.2 0.866 | 15.20 ± 0.35 0.598 | 15.40 ± 0.2 0.606 | 30.50 min 1.201 min | 15.20 ± 0.35 0.598 | 96.00 |
| (7) | 9578495402 9598495402 9595495402 | EER49/54 | 49.00 ± 0.8 1.929 | 27.00 ± 0.2 1.063 | 17.20 ± 0.35 0.677 | 18.70 ± 0.2 0.736 | 36.50 min 1.437 min | 17.20 ± 0.35 0.677 | 158.00 |

Quick Link: www.fair-rite.com/eer

Magnetic Core Parameters

Table Continued ...

| Row # | Part Number | $\sum lA(\text{cm}^{-1})$ | $l_e(\text{cm})$ | $A_e(\text{cm}^2)$ | $V_e(\text{cm}^3)$ | $A_{\min}(\text{cm}^2)$ | $A_L(\text{nH})$ |
|-------|--|---------------------------|------------------|--------------------|--------------------|-------------------------|-------------------------------------|
| (1) | 9578261802 9598261802 9595261802 | 11.10 | 4.80 | 0.434 | 2.083 | 0.425 | 1800 ±25% 1800 ±25% 2200 ±25% |
| (2) | 9578282802 9598282802 9595282802 | 7.30 | 6.29 | 0.859 | 5.398 | 0.77 | 2800 ±25% 2800 ±25% 3500 ±25% |
| (3) | 9578283402 9598283402 9595283402 | 8.70 | 7.44 | 0.852 | 6.337 | 0.77 | 2600 ±25% 2710 ±25% 3350 ±25% |
| (4) | 9578354202 9598354202 9595354202 | 8.20 | 9.11 | 1.11 | 10.14 | 1.00 | 2600 ±25% 2800 ±25% 3200 ±25% |
| (5) | 9578404602 9598404602 9595404602 | 6.90 | 10.00 | 1.44 | 14.42 | 1.30 | 3400 ±25% 3600 ±25% 4200 ±25% |
| (6) | 9578424402 9598424402 9595424402 | 5.20 | 9.79 | 1.87 | 18.26 | 1.81 | 4000 ±25% 4100 ±25% 5900 ±25% |
| (7) | 9578495402 9598495402 9595495402 | 4.80 | 11.80 | 2.45 | 29.02 | 2.32 | 4200 ±25% 5350 ±25% 6500 ±25% |

The U core offers an economical core design with a nearly uniform cross-sectional area. In a power ferrite material they are frequently used in output chokes, power input filters and transformers for switched-mode power supplies and HF fluorescent ballasts.

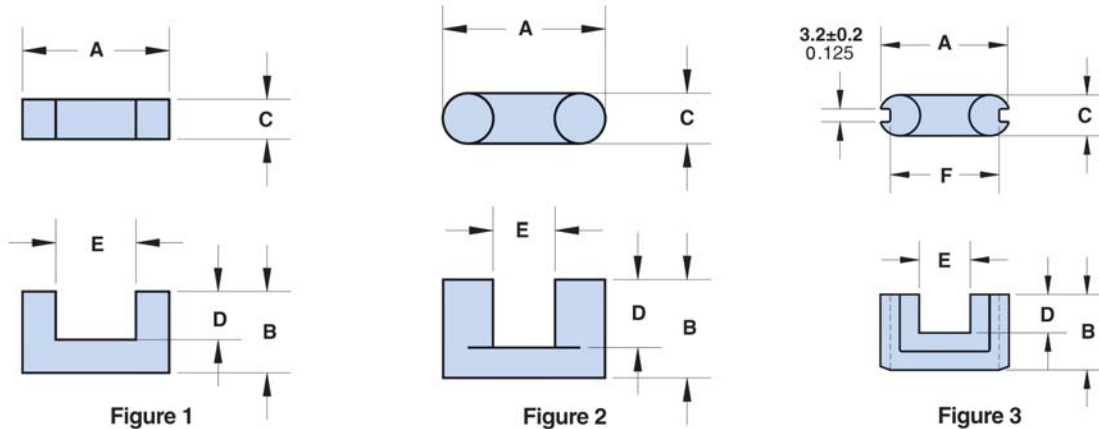

- These U cores have the same minimum cross-sectional area as the listed effective cross-sectional area.
- A_L value is measured at 1kHz, < 10 gauss.
- For any U core requirement not listed in the catalog, please contact our customer service group for availability and pricing.
- Explanation of Part Numbers: Digits 1&2 = product class, 3&4 = material grade.
- Weight indicated is per pair or set.

Legend: Symbols & Definition

Dimensions (Top numbers are in millimeters, bottom numbers are in nominal inches.)

$\Sigma \ell / A$: Core Constant, ℓ_e : Effective Path Length, A_e : Effective Cross-Sectional Area, V_e : Effective Core Volume, A_L : Inductance Factor ($\frac{L}{N^2}$)

Explanation of part numbers: Digits 1 & 2 = product class, 3 & 4 = material grade.

MnZn 77 material

| Row # | Part Number | Fig. | A | B | C | D | E | F | Wt. (g) per Set |
|-------|-------------|------|----------------------|----------------------|----------------------|------------------------|------------------------|----------------------|-----------------|
| (1) | 9077002002 | 1 | 8.90 -0.50 0.340 | 4.45 +0.25 0.180 | 4.05 ±0.20 0.160 | 1.30 Min 0.051 Min | 2.30 Min 0.090 Min | — | 1.40 |
| (2) | 9077026002 | 1 | 25.40 ±0.75 1.000 | 12.60 ±0.25 0.500 | 6.60 -0.50 0.250 | 6.20 Min 0.244 Min | 12.45 Min 0.490 Min | — | 15.00 |
| (3) | 9077025002 | 1 | 25.40 ±0.75 1.000 | 15.75 ±0.25 0.625 | 6.60 -0.50 0.250 | 9.40 Min 0.370 Min | 12.45 Min 0.490 Min | — | 17.50 |
| (4) | 9077024002 | 1 | 25.40 ±0.75 1.000 | 18.90 ±0.25 0.750 | 6.60 -0.50 0.250 | 12.55 Min 0.494 Min | 12.45 Min 0.490 Min | — | 20.00 |
| (5) | 9277023002 | 2 | 26.50 ±0.70 1.045 | 15.75 ±0.25 0.625 | 10.00 -0.50 0.385 | 10.00 Min 0.394 Min | 7.25 Min 0.285 Min | — | 28.00 |
| (6) | 9277002002 | 2 | 26.50 ±0.70 1.045 | 20.20 ±0.15 0.795 | 10.00 -0.50 0.385 | 14.35 Min 0.565 Min | 7.25 Min 0.285 Min | — | 32.00 |
| (7) | 9277024002 | 3 | 31.40 ±0.60 1.237 | 18.50 ±0.15 0.729 | 10.25 -0.50 0.394 | 9.40 Min 0.370 Min | 12.50 Min 0.492 Min | 26.60 ±0.5 1.047 | 35.00 |
| (8) | 9277008002 | 3 | 41.15 ±0.75 1.620 | 17.45 ±0.15 0.687 | 11.70 ±0.25 0.460 | 7.80 Min 0.307 Min | 18.65 Min 0.735 Min | 35.30 ±0.60 1.390 | 50.00 |
| (9) | 9277010002 | 3 | 41.15 ±0.75 1.620 | 20.50 ±0.25 0.812 | 11.70 ±0.25 0.460 | 10.95 Min 0.430 Min | 18.65 Min 0.735 Min | 35.30 ±0.60 1.390 | 54.00 |
| (10) | 9277012002 | 3 | 41.15 ±0.75 1.620 | 25.40 ±0.15 1.000 | 11.70 ±0.25 0.460 | 15.75 Min 0.620 Min | 18.65 Min 0.735 Min | 35.30 ±0.60 1.390 | 66.00 |

Quick Link: www.fair-rite.com/uc

Table Continued ...

| Row # | Part Number | $\sum lA(\text{cm}^{-1})$ | $l_e(\text{cm})$ | $A_e(\text{cm}^2)$ | $V_e(\text{cm}^3)$ | $A_L(\text{nH})$ |
|-------|-------------|---------------------------|------------------|--------------------|--------------------|------------------|
| (1) | 9077002002 | 16.80 | 2.08 | 0.124 | 0.257 | 695 Min |
| (2) | 9077026002 | 17.60 | 7.10 | 0.40 | 2.85 | 940 Min |
| (3) | 9077025002 | 20.70 | 8.40 | 0.40 | 3.36 | 790 Min |
| (4) | 9077024002 | 23.90 | 9.60 | 0.40 | 3.88 | 695 Min |
| (5) | 9277023002 | 11.60 | 7.80 | 0.67 | 5.20 | 1390 Min |
| (6) | 9277002002 | 13.90 | 9.50 | 0.68 | 6.50 | 1180 Min |
| (7) | 9277024002 | 11.20 | 9.30 | 0.83 | 7.70 | 1425 Min |
| (8) | 9277008002 | 10.50 | 10.30 | 0.98 | 10.10 | 1575 Min |
| (9) | 9277010002 | 11.80 | 11.60 | 0.98 | 11.30 | 1425 Min |
| (10) | 9277012002 | 13.80 | 13.50 | 0.98 | 13.20 | 1255 Min |

Quick Link: www.fair-rite.com/ep

EP7, EP10, EP13, EP17, EP20

EP designs reduce the effect of residual air gap upon the effective permeability of the core, hence they minimize coil volume for a given inductance. EP cores also provide a high degree of isolation from adjacent components and are advantageously used in low power devices, matching and broadband transformers.

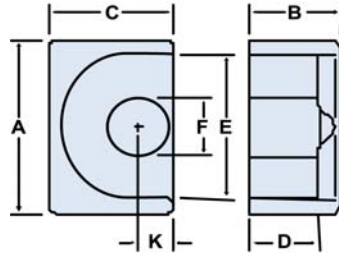

- EP cores can be supplied with the center post gapped to a mechanical dimension or an A_L value.
- A_L value is measured at 1 kHz, $B < 10$ gauss
- Weigh indicates is per pair or set.

Legend: Symbols & Definition

Dimensions (Top numbers are in millimeters, bottom numbers are in nominal inches.)

$\Sigma \ell / A$: Core Constant, ℓ_e : Effective Path Length, A_e : Effective Cross-Sectional Area, V_e : Effective Core Volume, A_L : Inductance Factor ($\frac{L}{N^2}$)

Explanation of part numbers: Digits 1 & 2 = product class, 3 & 4 = material grade.

Dimensions

| Row # | Part Number | Generic Size | A | B | C | D | E | F | K | Wt. (g) per Set |
|-------|--|--------------|----------------------|----------------------|----------------------|---------------------|-----------------------|---------------------|-----------------------|-----------------|
| (1) | 6578070121 6598070121 6595070121 | EP7 | 9.20 ± 0.2 0.362 | 3.70 ± 0.2 0.146 | 6.40 ± 0.2 0.252 | 2.70 ± 0.2 0.106 | 7.20 min 0.283 min | 3.30 ± 0.1 0.130 | 1.80 min 0.071 min | 0.70 |
| (2) | 6578100121 6598100121 6595100121 | EP10 | 11.50 ± 0.3 0.453 | 5.10 ± 0.2 0.201 | 7.70 ± 0.2 0.303 | 3.80 ± 0.2 0.150 | 9.40 ± 0.2 0.370 | 3.30 ± 0.2 0.130 | 1.95 min 0.077 min | 1.40 |
| (3) | 6578130121 6598130121 6595130121 | EP13 | 12.50 ± 0.3 0.492 | 6.50 ± 0.3 0.256 | 8.80 ± 0.2 0.346 | 4.70 ± 0.2 0.185 | 10.00 ± 0.3 0.394 | 4.40 ± 0.2 0.173 | 2.50 min 0.098 min | 2.35 |
| (4) | 6578170121 6598170121 6595170121 | EP17 | 18.10 ± 0.4 0.713 | 8.40 ± 0.4 0.331 | 11.00 ± 0.3 0.433 | 5.70 ± 0.2 0.224 | 12.00 ± 0.4 0.472 | 5.70 ± 0.2 0.224 | 3.45 min 0.136 min | 6.00 |
| (5) | 6578200121 6598200121 6595200121 | EP20 | 24.00 ± 0.5 0.945 | 10.70 ± 0.2 0.421 | 15.00 ± 0.4 0.591 | 7.20 ± 0.2 0.283 | 16.50 ± 0.4 0.650 | 8.80 ± 0.2 0.346 | 4.70 min 0.185 min | 13.50 |

Quick Link: www.fair-rite.com/ep

Magnetic Core Parameters

Table Continued ...

| Row # | Part Number | $\sum lA(\text{cm}^{-1})$ | $l_e(\text{cm})$ | $A_e(\text{cm}^2)$ | $V_e(\text{cm}^3)$ | $A_{\min}(\text{cm}^2)$ | $A_L(\text{nH})$ |
|-------|--|---------------------------|------------------|--------------------|--------------------|-------------------------|-------------------------------------|
| (1) | 6578070121 6598070121 6595070121 | 14.40 | 1.48 | 0.103 | 0.152 | 0.085 | 990 ±25% 1020 ±25% 1180 ±25% |
| (2) | 6578100121 6598100121 6595100121 | 16.80 | 1.85 | 0.11 | 0.203 | 0.085 | 1000 ±25% 1050 ±25% 1200 ±25% |
| (3) | 6578130121 6598130121 6595130121 | 11.80 | 2.32 | 0.197 | 0.457 | 0.148 | 1600 ±25% 1650 ±25% 1800 ±25% |
| (4) | 6578170121 6598170121 6595170121 | 8.00 | 2.68 | 0.336 | 0.899 | 0.252 | 2250 ±25% 2300 ±25% 2750 ±25% |
| (5) | 6578200121 6598200121 6595200121 | 4.80 | 3.76 | 0.789 | 2.96 | 0.60 | 4100 ±25% 4250 ±25% 5000 ±25% |

Product Capability

1. We like to be challenged! If your requirements call for an unusual core configuration, don't give up if you can't find it in existing ferrite catalogs. Give us a call. Usually all we need to get started on your design is some preliminary information, such as the operating frequency and estimated usage.

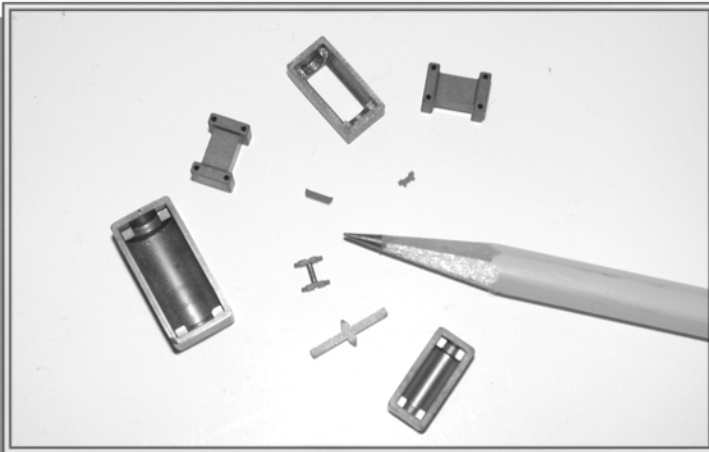
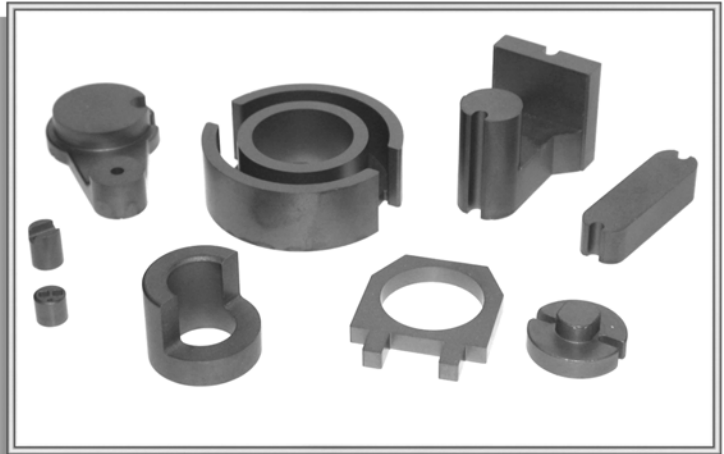

2. Precise small components are one of our specialties. We have a range of NiZn and MnZn ferrite material grades to accommodate small inductive component designs. If specific tooling is required to manufacture *your* part, that tool will only be used to manufacture *your* design.

3. Fair-Rite Products Corp. manufactures a range of rods with centerless ground diameters down to 0.5 mm (0.020") and lengths up to 10 mm (0.395"). We can also supply pressed rods with a diameter as small as 0.5 mm and 2-3 mm long. We are fully equipped to Parylene coat rods if required. Sorting for length is also possible.

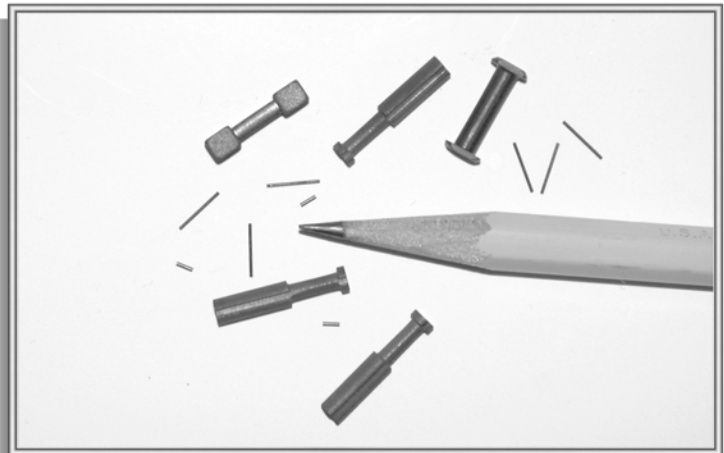

Fair-Rite Products Corp. PO Box 288, One Commercial Row, Wallkill, NY 12589-0288

Product Capability

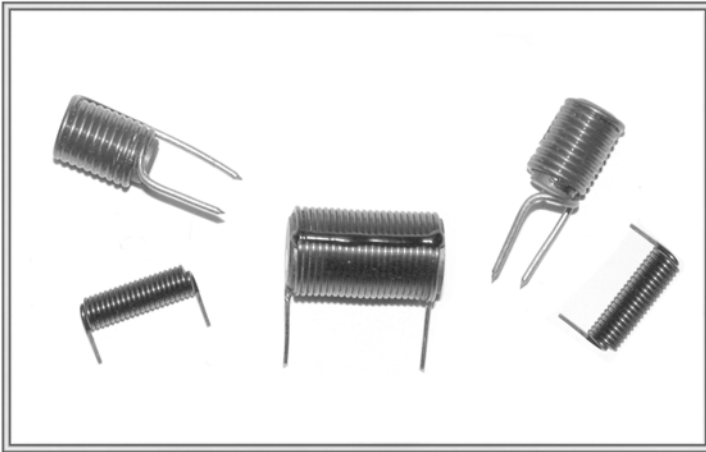

4. Our pressed rods and centerless ground rods can also be supplied as wound rods. We offer several material grades for these product lines. To be cost-competitive, these rods are wound in one of our manufacturing facilities in China.

5. We can supply application customer specific parts in one of our ferrite materials to facilitate the design process. Prior to deciding on the final core shape and material selection, machined samples can be provided for testing purposes.

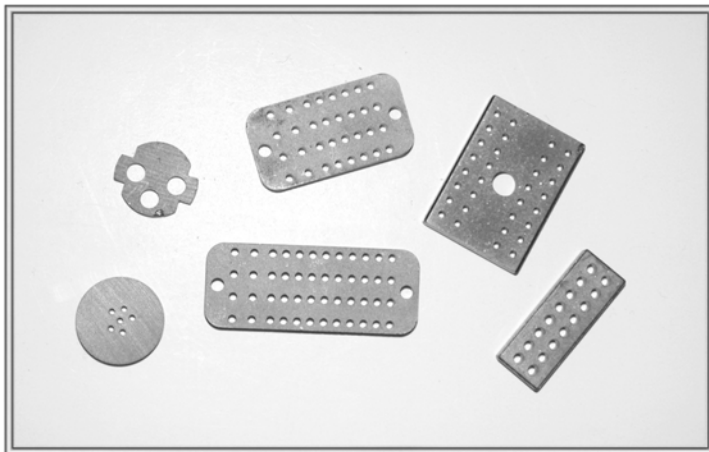
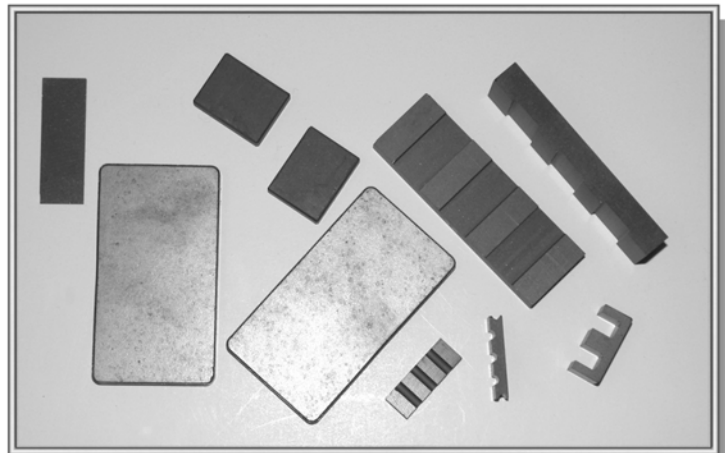

6. Over the years we've tooled a diverse range of connector plate configurations in our NiZn 44 and 61 material. Tooling can be expensive, depending upon the complexity of the connector plate, and only sizeable annual quantities make this solution cost-effective. Again, before a design is finalized, machined prototypes can be supplied to verify your design's viability.

Fair-Rite Products Corp. PO Box 288, One Commercial Row, Wallkill, NY 12589-0288

Phone: (888) FAIR RITE / (845) 895-2055 • Fax: (888) FERRITE / (845) 895-2629 • Web: www.fair-rite.com
(888) 324-7748 (888) 337-7483 E -mail: ferrites@fair-rite.com

Reference Tables

Ferrite Material Constants

| | |
|---------------------------------------|--|
| Specific Heat | 0.25 cal/g/°C |
| Thermal Conductivity | 3.5 - 4.5 mW/cm - °C |
| Coefficient of Linear Expansion | 8 - 10x10 ⁻⁶ /°C |
| Tensile Strength | 4.9 kgf/mm ² |
| Compressive Strength | 42 kgf/mm ² |
| Young's Modulus | 15x10 ³ kgf/mm ² |
| Hardness (Knoop) | 650 |
| Specific Gravity | ≈ 4.7 |

The above quoted properties are typical for Fair-Rite MnZn and NiZn ferrites.

Properties of Parylene C Coating Material

| | | |
|--|----------------------|-------------------|
| Dielectric Strength | 5600 | V/mil |
| Volume Resistivity | 8.8x10 ¹⁶ | ohm-cm |
| Surface Resistivity | 10 ¹⁴ | ohm |
| Dielectric Constant (1MHz) | 2.95 | |
| Dissipation Factor (1MHz) | 0.013 | |
| Density | 1.29 | g/cm ³ |
| Water Absorption (24 hrs) | <0.1 | % |
| Coefficient of Friction | 0.29 | |
| Continuous Operating Temperature | <100 | °C |
| Thermal Conductivity | 2.0x10 ⁻⁴ | cal/sec/cm/°C |
| Maximum Operating Temperature | <160 | °C |

Conversion Table

| SI Units | CGS Units |
|-----------------------------------|-------------------------|
| 1 T (tesla) = 1 Vs/m ² | = 10 ⁴ gauss |
| 1 mT | = 10 gauss |
| 1 A/m = 10 ⁻² A/cm | = 0.0125 oersted |
| .1 mT | = 1 gauss |
| 80 A/m | = 1 oersted |

Greek Alphabet

| | | | |
|------------|---------|------------|---------|
| A, α | Alpha | N, ν | Nu |
| B, β | Beta | Ξ, ξ | Xi |
| Γ, γ | Gamma | O, ο | Omicron |
| Δ, δ | Delta | Π, π | Pi |
| E, ε | Epsilon | Ρ, ρ | Rho |
| Z, ζ | Zeta | Σ, σ | Sigma |
| H, η | Eta | Τ, τ | Tau |
| Θ, θ | Theta | Υ, υ | Upsilon |
| I, ι | Iota | Φ, φ | Phi |
| K, κ | Kappa | X, χ | Chi |
| Λ, λ | Lambda | Ψ, ψ | Psi |
| M, μ | Mu | Ω, ω | Omega |

Glossary of Terms

Air Core Inductance - L_o (henry)

The inductance that would be measured if the core had unity permeability and the flux distribution remained unaltered.

Coercive Force - H_c (oersted or A/m)

The magnetizing field strength required to bring the magnetic flux density of the magnetized material to zero.

Core Constant - C_1 (cm^{-1})

The summation of the magnetic path lengths of each section of a magnetic circuit divided by the corresponding magnetic area of the same section.

Core Constant - C_2 (cm^{-3})

The summation of the magnetic path lengths of each section of a magnetic circuit divided by the square of the corresponding magnetic area of the same section.

Curie Temperature - T_c ($^{\circ}\text{C}$)

The transition temperature above which a ferrite loses its ferrimagnetic properties.

Disaccommodation - D

The proportional decrease of permeability after a disturbance of magnetic material, measured at constant temperature, over a given time interval.

Disaccommodation Factor - DF

The disaccommodation factor if the disaccommodation after magnetic conditioning divided by the permeability of the first measurement times \log_{10} of the ratio of time intervals.

Effective Dimensions of a Magnetic Circuit -

Area A_e (cm^2), Path Length ℓ_e (cm) and Volume V_e (cm^3)

For a magnetic core of given geometry, the magnetic path length, the cross-sectional area and the volume that a hypothetical toroidal core of the same material properties should possess to be the magnetic equivalent to the given core.

Field Strength - H (oersted or A/m)

The parameter characterizing the amplitude of the alternating field strength.

Flux Density - B (gauss or mT)

The corresponding parameter for the induced magnetic field in an area perpendicular to the flux path.

Flux Density, saturation - B_s (gauss or mT)

The maximum intrinsic induction possible in a material.

Inductance Factor - A_L (nH)

Inductance of a coil on a specified core divided by the square of the number of turns. (Unless otherwise specified the inductance test conditions for the inductance factor are at flux density <10gauss).

Loss Factor - $\tan \delta/\mu_i$

The phase of displacement between the fundamental components of the flux density and the field strength divided by the initial permeability.

Magnetic Constant - μ_o

The permeability of free space.

Magnetic Hysteresis

In the magnetic material, the irreversible variation of the flux density or the magnetization which is associated with the change of magnetic field strength and is independent of the rate change.

Magnetically Soft Material

A magnetic material with low coercivity.

Permeability, amplitude - μ_a

The quotient of the peak value of the flux density and the peak value of the applied field strength at a stated amplitude of either, with no static present.

Permeability, complex series - μ_s', μ_s''

The real and imaginary components respectively of the complex permeability expressed in series terms.

Permeability, effective - μ_e

For a magnetic circuit constructed with an air gap or air gaps, the permeability of a hypothetical homogeneous material which would provide the same reluctance.

Permeability, incremental - μ_{Δ}

Under stated conditions the permeability obtained from the ratio of the flux density and the applied field strength of an alternating field and a superimposed static field.

Permeability, initial - μ_i

The permeability obtained from the ratio of the flux density, kept at <10 gauss, and the required applied field strength. Material initially in a specified neutralized state.

Power Loss Density - P (mW/cm³)

The power absorbed by a body of ferrimagnetic material and dissipated as heat, when the body is subject to an alternating field which results in a measurable temperature rise. The total loss is divided by the volume of the body.

Remanence - B_r (gauss or mT)

The flux density remaining in a magnetic material when the applied magnetic field strength is reduced to zero.

Temperature Coefficient - TC

The relative change of the quantity considered, divided by the difference in the temperatures producing it.

Temperature Factor - TF

The fractional change in the initial permeability over temperature range, divided by the initial permeability.

Soft Ferrite References

IEC Publications on Soft Ferrite Materials and Components

| | |
|--------------|--|
| IEC 60133 | Dimensions of pot cores made of magnetic oxides and associated parts. |
| IEC 60205 | Calculations of the effective parameters of magnetic piece parts. |
| IEC 60401-1 | Terms and nomenclature for cores made of magnetically soft ferrites. Part 1: Terms used for physical irregularities. |
| IEC 60401-2 | Terms and nomenclature for cores made of magnetically soft ferrites. Part 2: Reference of dimensions. |
| IEC 60401-3 | Terms and nomenclature for cores made of magnetically soft ferrites. Part 3: Guidelines on the format of data appearing in manufacturers' catalogues of transformers and inductors cores. |
| IEC 60424-1 | Ferrite cores. Guides on the limits of surface irregularities. Part 1: General specification. |
| IEC 60424-2 | Guidance of the limits of surface irregularities of ferrite cores. Part 2: RM cores. |
| IEC 60424-3 | Ferrite cores. Guide on the limits of surface irregularities. Part 3: ETD cores and E cores. |
| IEC 60424-4 | Ferrite cores. Guide on the limits of surface irregularities. Part 4: Ring cores. |
| IEC 60647 | Dimensions for magnetic oxide cores intended for use in power supplies (EC cores). |
| IEC 60732 | Measuring methods for cylinder cores, tubes cores and screw cores of magnetic oxides. |
| IEC 61007 | Transformers and inductors for use in telecommunication equipment. Measuring methods and test procedures. |
| IEC 61185 | Magnetic oxide cores (ETD cores) intended for use in power supply applications. Dimensions. |
| IEC 61247 | PM cores made of magnetic oxide and associated parts. Dimensions. |
| IEC 61332 | Soft ferrite material classification. |
| IEC 61333 | Marking on U and E ferrite cores. |
| IEC 61596 | Magnetic oxide EP cores and associated parts for use in inductors and transformers. Dimensions. |
| IEC/TR 61604 | Dimensions of uncoated ring cores of magnetic oxides. |

Soft Ferrite References

| | |
|---------------|--|
| IEC 61631 | Test method for the mechanical strength of cores made of magnetic oxides. |
| IEC 62024-1 | High frequency inductive components. Electrical characteristics and measuring methods. Part 1: Nanohenry range chip inductors. |
| IEC 62044-1 | Cores made of soft magnetic materials. Measuring methods. Part 1: Generic specification. |
| IEC 62044-2 | Cores made of soft magnetic materials. Measuring methods. Part 2: Magnetic Properties at low excitation level. |
| IEC 62044-3 | Cores made of soft magnetic materials. Measuring methods. Part 3: Magnetic properties at high excitation level. |
| IEC 62211 | Inductive components. Reliability management. |
| IEC 62317-1 | Ferrite cores - Dimensions - Part 1: General specifications. |
| IEC 62317-4 | Ferrite cores - Dimensions - Part 4: RM-cores and associated parts. |
| IEC 62317-7 | Ferrite cores - Dimensions - Part 7: EER-cores |
| IEC 62317-8 | Ferrite cores - Dimensions - Part 8: E-cores |
| IEC 62317-9 | Ferrite cores - Dimensions - Part 9: Planar cores. Amendment 1. |
| IEC/PAS 62323 | Dimensions of half pot cores of magnetic oxides for inductive proximity switches. |
| IEC 62358 | Ferrite cores. Standard inductance factor (AI) and its tolerance. |
| IEC/TS 62398 | Ferrite cores. Technology approval schedule (TAS). |

The International Electrotechnical Commission (IEC) is the world organization that prepares and publishes international standards for all electrical, electronic and related technologies. Founded in 1906, the IEC is presently composed of more than 60 participating countries, including all the world's major trading nations and a growing number of industrializing countries.

The above publications have been issued by the IEC Technical Committee No. 51: Magnetic Components and Ferrite Materials. Publications can be purchased from the American National Standards Institute. Visit their web site webstore.ansi.org to purchase the documents.

Reference Books for Soft Ferrite Applications

Ferrites for Inductors and Transformers, 1983
Snelling, E.C. and Giles, A.D. , John Wiley & Sons, New York, NY

Soft Ferrites, Properties and Applications, 2nd Edition, 1988
Snelling, E.C. , Butterworths, Stoneham, MA

Transformer and Inductor Design Handbook, 1988
McLyman, Wm. T., Marcel Dekker, New York, NY

Transmission Line Transformers, 1990
Sevick, J., American Radio Relay League, Newington, CT

Soft Magnetic Materials, 1979
Boll, R., John Wiley & Sons, New York, NY

Transformers for Electronic Circuits, 2nd Edition, 1990
Grossner, N., McGraw Hill, New York, NY

Modern Ferrite Technology, Second Edition, 1999
Goldman, A., Kluwer Academic Publishers, Boston/
Dordrecht, Netherlands

Magnetic Design Formulas

Effective Core Parameters

$$C_1 = \Sigma l/A \quad (\text{cm}^{-1}) \quad C_2 = \Sigma l/A^2 \quad (\text{cm}^{-3})$$

$$\ell_e = C_1^2/C_2 \quad (\text{cm}), \quad A_e = C_1/C_2 \quad (\text{cm}^2)$$

Magnetic path is divided into elements with length ℓ and cross-sectional area A .

$$V_e = C_1^3/C_2^2 \quad (\text{cm}^3)$$

Flux Density Peak

$$\hat{B} = \frac{E 10^8}{4.44 f N A_e} \quad (\text{gauss})$$

Field Strength (Peak)

$$\hat{H} = \frac{0.4 \pi N I_p}{\ell_e} \quad (\text{oersted})$$

Where E = RMS sine wave voltage (V)
 f = Frequency (Hz)
 A_e = Effective cross-sectional area (cm²)
 ℓ_e = Effective path length (cm)
 I_p = Peak current (A)
 N = Number of turns

* To check for maximum peak flux density in a non-uniform core set substitute A_{\min} for A_e .

Air Core Inductance

$$L_o = \frac{4 \pi N^2 10^{-9}}{C_1} \quad (\text{H})$$

C_1 in cm⁻¹

Number of Turns

$$N = \sqrt{\frac{L 10^9}{A_L}} \quad L \text{ in H}$$

Inductance

$$L = N^2 A_L \quad (\text{nH})$$

$$L = \mu_i \frac{4 \pi N^2}{C_1} 10^{-9} \quad (\text{H})$$

$$L = \mu_e \frac{4 \pi N^2}{C_1} 10^{-9} \quad (\text{H}) \quad \left. \vphantom{\frac{4 \pi N^2}{C_1}} \right\} C_1 \text{ in cm}^{-1}$$

Effective Permeability

$$\mu_e = \frac{\ell_e}{\ell_o/\mu_i + \ell}$$

Where ℓ_e = Effective path length
 ℓ = Air gap length

Attenuation

$$A = 20 \log_{10} \frac{|Z_s + Z_L + Z_{sc}|}{|Z_s + Z_L|} \quad (\text{dB})$$

Where Z_s = Source impedance
 Z_L = Load impedance
 Z_{sc} = Suppression core impedance

Quality Factor

$$Q = \frac{2 \pi f L_s}{R_s} = \frac{R_p}{2 \pi f L_p}$$

Wire Table of Copper Magnet Wire

| AWG & B&S Gauge | Diameter (Inch) | Cross-Sectional Area | | Feet per Ohm (20°C) | Ohms per 1000 ft (20°C) | Amperes for 1mA/cir mil | Turns per Inch ² |
|-----------------|-----------------|----------------------|------------|---------------------|-------------------------|-------------------------|-----------------------------|
| | | (Inch ²) | (cir mils) | | | | |
| 10 | 0.1019 | 0.00815 | 10380 | 1001 | 1.00 | 10.4 | 92 |
| 11 | 0.0907 | 0.00647 | 8234 | 794 | 1.26 | 8.25 | 118 |
| 12 | 0.0808 | 0.00513 | 6530 | 630 | 1.59 | 6.54 | 146 |
| 13 | 0.0719 | 0.00407 | 5178 | 499 | 2.00 | 5.18 | 180 |
| 14 | 0.0641 | 0.00322 | 4107 | 396 | 2.53 | 4.11 | 231 |
| 15 | 0.0571 | 0.00256 | 3257 | 314 | 3.18 | 3.26 | 275 |
| 16 | 0.0508 | 0.00203 | 2583 | 249 | 4.02 | 2.59 | 346 |
| 17 | 0.0453 | 0.00161 | 2048 | 198 | 5.06 | 2.05 | 432 |
| 18 | 0.0403 | 0.00127 | 1624 | 157 | 6.39 | 1.62 | 544 |
| 19 | 0.0359 | 0.00101 | 1288 | 124 | 8.05 | 1.29 | 679 |
| 20 | 0.0320 | 0.000804 | 1022 | 98.5 | 10.2 | 1.03 | 854 |
| 21 | 0.0285 | 0.000638 | 810.1 | 78.1 | 12.8 | 0.81 | 1065 |
| 22 | 0.0254 | 0.000505 | 642.4 | 62.0 | 16.1 | 0.64 | 1345 |
| 23 | 0.0226 | 0.000400 | 509.5 | 49.1 | 20.4 | 0.51 | 1675 |
| 24 | 0.0201 | 0.000317 | 404.0 | 39.0 | 25.7 | 0.40 | 2095 |
| 25 | 0.0179 | 0.000252 | 320.4 | 30.9 | 32.4 | 0.321 | 2630 |
| 26 | 0.0159 | 0.000200 | 254.1 | 24.5 | 40.8 | 0.255 | 3325 |
| 27 | 0.0142 | 0.000158 | 201.5 | 19.4 | 51.4 | 0.201 | 4110 |
| 28 | 0.0126 | 0.000126 | 159.8 | 15.4 | 64.9 | 0.160 | 5210 |
| 29 | 0.0113 | 0.000100 | 126.7 | 12.2 | 81.9 | 0.128 | 6385 |
| 30 | 0.0100 | 0.0000785 | 100.5 | 9.7 | 103.1 | 0.100 | 8145 |
| 31 | 0.0089 | 0.0000622 | 79.7 | 7.7 | 130.1 | 0.079 | 10,097 |
| 32 | 0.0080 | 0.0000503 | 63.2 | 6.1 | 163 | 0.064 | 12,270 |
| 33 | 0.0071 | 0.0000396 | 50.1 | 4.8 | 206 | 0.050 | 15,615 |
| 34 | 0.0063 | 0.0000312 | 39.8 | 3.83 | 261 | 0.040 | 19,655 |
| 35 | 0.0056 | 0.0000248 | 31.5 | 3.04 | 330 | 0.0316 | 25,530 |
| 36 | 0.0050 | 0.0000196 | 25.0 | 2.41 | 415 | 0.0250 | 31,405 |
| 37 | 0.0045 | 0.0000159 | 19.8 | 1.91 | 524 | 0.0203 | 39,570 |
| 38 | 0.0040 | 0.0000126 | 15.7 | 1.52 | 670 | 0.0160 | 49,070 |
| 39 | 0.0035 | 0.00000962 | 12.5 | 1.20 | 832 | 0.0122 | 65,790 |
| 40 | 0.0031 | 0.00000755 | 9.89 | 0.953 | 1049 | 0.0098 | 82,180 |
| 41 | 0.0028 | 0.00000616 | 7.84 | 0.756 | 1323 | 0.0079 | 98,860 |
| 42 | 0.0025 | 0.00000491 | 6.20 | 0.598 | 1672 | 0.0062 | 121,175 |
| 43 | 0.0022 | 0.00000380 | 4.93 | 0.476 | 2101 | 0.0048 | 158,245 |
| 44 | 0.0020 | 0.00000314 | 3.88 | 0.374 | 2674 | 0.0039 | 205,515 |
| 45 | 0.0018 | 0.00000254 | 3.10 | 0.299 | 3344 | 0.0032 | 249,855 |
| 46 | 0.0016 | 0.00000201 | 2.46 | 0.238 | 4202 | 0.0025 | 310,205 |

Fair-Rite Products Corp. PO Box 288, One Commercial Row, Wallkill, NY 12589-0288

Phone: (888) FAIR RITE / (845) 895-2055 • Fax: (888) FERRITE / (845) 895-2629 • Web: www.fair-rite.com
 (888) 324-7748 (888) 337-7483 E-mail: ferrites@fair-rite.com

Use of Ferrites in Broadband Transformers

Introduction

Most of the magnetic information in this catalog is data obtained from cores wound with a single multi-turn-winding which forms an inductor. When a second winding is added on the core, the inductor becomes a transformer. Depending on the requirements, transformers can be designed to provide dc isolation, impedance matching and specific current or voltage ratios. Transformer designed for power, broadband, pulse, or impedance matching can often be used over a broad frequency spectrum.

In many transformer designs ferrites are used as the core material. This article will address the properties of the ferrite materials and core geometries which are of concern in the design of low power broadband transformers.

Brief Theory

Broadband transformers are wound magnetic devices that are designed to transfer energy over a wide frequency range. Most applications for broadband transformers are in telecommunication equipment where they are extensively used at a low power levels.

Figure 1 shows a typical performance curve of insertion loss as a function of frequency for a broadband transformer. The bandwidth of a broadband transformer is the frequency difference between f_2 and f_1 , or between f_2' and f_1' , and is a function of the specified insertion loss and the transformer roll-off characteristics.

It can be seen that the bandwidth is narrower for transformers with a steep roll-off ($f_2' - f_1'$) than those with a more gradual roll-off ($f_2 - f_1$). Also in Figure 1, the three frequency regions are identified.

The cutoff frequencies are determined by the requirements of the individual broadband transformer design. Therefore, f_1 can be greater than 10 MHz or less than 300 Hz. Bandwidths also can vary from a few hundred hertz to hundreds of MHz. A typical

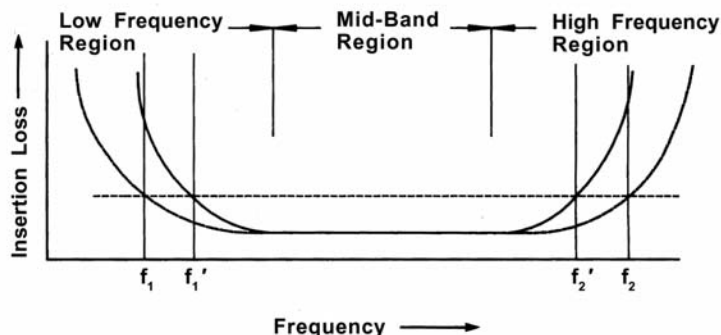

Figure 1 Typical Characteristic Curve of Insertion Loss vs. Frequency for a broadband transformer.

broadband transformer design will specify for the mid frequency range a maximum insertion loss and for the cutoff frequencies, f_1 and f_2 maximum allowable losses. Figure 2 is a schematic diagram of the lumped element equivalent circuit of a transformer, separating the circuit into an ideal transformer, its components and equivalent parasitic resistances and reactances. The secondary components, parasitics and the load resistance have been transferred to the primary side and are identified with a prime.

To simplify this circuit, the primary and secondary circuit elements have been combined and the equivalent reduced circuit is shown in Figure 3. The physical significance of the parameters are listed below the equivalent circuits. In the low frequency region the roll-off in transmission characteristics is due a lowering of the shunt impedance. The shunt impedance decreases when the frequency is reduced, which results in the increases level of attenuation. The impedance is mainly a function of the

Technical Information

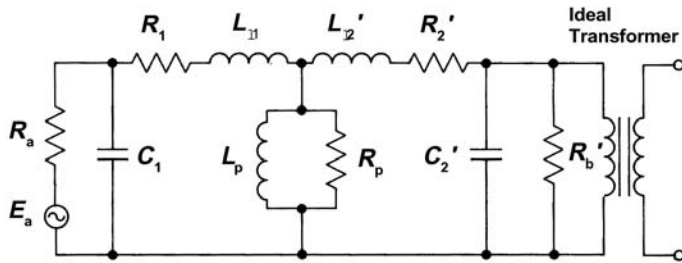

Figure 2 Lumped equivalent of a transformer.

- E_a = source EMF
- R_a = source resistance
- C_1 = primary winding capacitance
- R_1 = resistance of primary winding
- L_{t1} = primary leakage inductance
- L_p = open circuit inductance of primary winding
- R_p = shunt resistance that represents loss in core
- Secondary parameters reflected to the primary side.
- C_2' = secondary winding capacitance
- R_2' = resistance of secondary winding
- L_{t2}' = secondary leakage inductance
- R_b' = load resistance

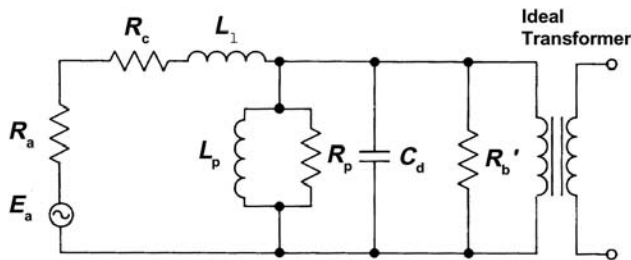

Figure 3 Simplified equivalent transformer circuit

$$C_d = C_1 + C_2'$$

$$R_c = R_1 + R_2'$$

$$L_t = L_{t1} + L_{t2}'$$

For other circuit parameters see Figure 2.

primary reactance X_{Lp} with a negligible contribution of the equivalent shunt loss resistance R_p . The insertion loss may therefore be expressed in terms of the shunt inductance:

$$A_i = 10 \log_{10} \left(1 + \left(\frac{R}{\omega L_p} \right)^2 \right) \text{ dB}$$

$$\text{Where } R = R_a \times R_b' / R_a = R_b'$$

For most ferrite broadband transformer designs, the only elements that are likely to effect the transmission at the mid-band frequency range are the winding resistances. The insertion loss for the mid-band frequency region due to the winding resistance may be expressed as:

$$A_i = 20 \log_{10} \left(1 + \frac{R_c}{R_a + R_b'} \right) \text{ dB}$$

$$\text{Where } R_c = R_1 + R_2'$$

In the higher frequency region the transmission characteristics are mainly a function of the leakage inductance or the shunt capacitance. It is often necessary to consider the effect of both of these reactances, depending upon the circuit impedance. In a low impedance circuit the high frequency droop due to leakage inductance is:

$$A_i = 10 \log_{10} \left(1 + \left(\frac{\omega L_t}{R_a + R_b'} \right)^2 \right) \text{ dB}$$

This high frequency droop in a high impedance circuit, due to the shunt capacitance, is as follows:

$$A_i = 10 \log_{10} \left(1 + (\omega CR)^2 \right) \text{ dB}$$

Reviewing the insertion loss characteristics for the three frequency regions, it can be concluded that the selection of ferrite material and core shape should result in a transformer design that yields the highest inductance per turn at the low frequency cutoff f_1 . This will result in the required shunt inductance for the low frequency region with the least number of turns. The low number of turns are desirable for low insertion loss at the mid-band region and also for low winding parasitics needed for good response at the high frequency cutoff f_2 .

Low and Medium Frequency Broadband Transformers

For broadband transformer applications the optimum ferrite is the material that has the highest initial permeability at the lower cutoff frequency f_1 . Manganese zinc ferrites, such as Fair-Rite 77 or 78 material, are very suitable for low and medium frequency broadband transformers designs. As stated before, the transformer parameter that is most critical is the shunt reactance (ωL), which will increase with frequency as long as the material permeability is constant or diminishing at a rate less than the increase in frequency. This holds true even if a transformer is designed using a manganese zinc ferrite where f_1 is at the higher end of the flat portion of the permeability vs. frequency curve. Although the whole bandpass lies in the area where the initial permeability is decreasing, yet the bandpass characteristics will be virtually unaffected. For broadband transformers that use a manganese zinc ferrite material the core geometry should be such as to minimize the R_{dc}/L ratio. In other words, the ratio of dc resistance to the inductance for a single turn should be a minimum. The range of pot cores, standardized by the International Electrotechnical Commission in document IEC 60133, has been designed for this minimum R_{dc}/L ratio. Other core shapes can also be used in the design of these broadband transformers. Often the final core selection will also be influenced by such considerations as ease of winding, terminating and other mechanical design constraints of the transformer.

Broadband Transformers with a Superimposed Static Field

In transformer designs that have a superimposed direct current, gapped cores can be employed to overcome the decrease in the shunt inductance. Hanna curves can be used to aid in the design of inductive devices that carry a direct current. For more information see section "The Effect of Direct Current on the Inductance of a Ferrite Core".

High Frequency Broadband Transformers.

Although there is no clear division between the frequency regions, for this article it is assumed that the high frequency broadband transformer designs use nickel zinc ferrites as the preferred core material. This will typically occur for transformer

designs where the bandpass lies wholly above 500 kHz. At these higher operating frequencies it becomes more important to consider the complex magnetic parameters of the core material, rather than use the simple core constants, such as A_L , recommended for low frequency designs.

Another important consideration is that high frequency transformers are generally used in low impedance circuits, which means that these designs require low shunt impedances. This can often be accomplished with a few turns, hence winding resistances are no longer an issue, and the design concept of minimizing R_{dc}/L is no longer required. The design will instead become focused on core shape and material for the required shunt impedance at f_1 along with reducing leakage inductance of the winding. Since the material characteristics permeability and losses affect the shunt impedance these parameters need to be considered in high frequency broadband transformer designs. Figures 4, 5 and 6 are typical curves of impedance Z , equivalent parallel reactance X_p and equivalent parallel loss resistance R_p as a function of frequency. They are measured on the same multi-aperture core 28—002302, in 73, 43, 61 & 67 material, wound with a single turn through both holes. For high frequency broadband transformers the toroidal core shape becomes an attractive core geometry. The few turns that are often required can easily be wound on the toroid. However, windings that require only a few turns may give rise to problems in obtaining the desired impedance ratios. To minimize leakage inductance it is suggested that the primary and secondary windings be tightly coupled and where possible a bifilar winding be used.

An improvement in core performance over toroids can be obtained by the use of multi-aperture cores, which can be considered as two toroidal cores side by side. This core shape has a lower single turn winding length than the equivalent toroidal core with the same core constant C_1 , and will result in a wider bandwidth of the transformer design. Many broadband transformers have been designed utilizing nickel zinc ferrite toroids with good results. If bandwidth requirements cannot be met using toroids, multi-aperture nickel zinc cores should be considered.

The multi-aperture cores are available in the nickel zinc ferrite materials 67, 61 and 43 as well as the manganese zinc ferrite 73 material.

Technical Information

Summary

The low cutoff frequency f_1 is the single most important factor in the ferrite material selection. The material with the highest initial permeability at f_1 is the recommended choice.

Manganese zinc ferrites, 77 and 78, can be used to a cutoff frequency f_1 of 500 kHz. Above this frequency use a nickel zinc ferrite, again depending upon the frequency f_1 , select 43, 61 or 67 material.

For low and medium frequency transformers the optimum core shape should provide the lowest DC resistance per unit of inductance. If there is a superimposed dc present the use of gapped cores and Hanna curves is suggested. For high frequency designs, use nickel zinc ferrite. The toroidal and multi-aperture cores are the recommended core configurations.

The number of turns should be kept to a minimum to reduce leakage inductance and self-capacitance of the windings. Wind primary and secondary windings tightly coupled or as bifilar windings to lower leakage inductance.

The "Multi-Aperature Core Kit", (part number 0199000036), contains a variety of components suited for broadband transformer design evaluations.

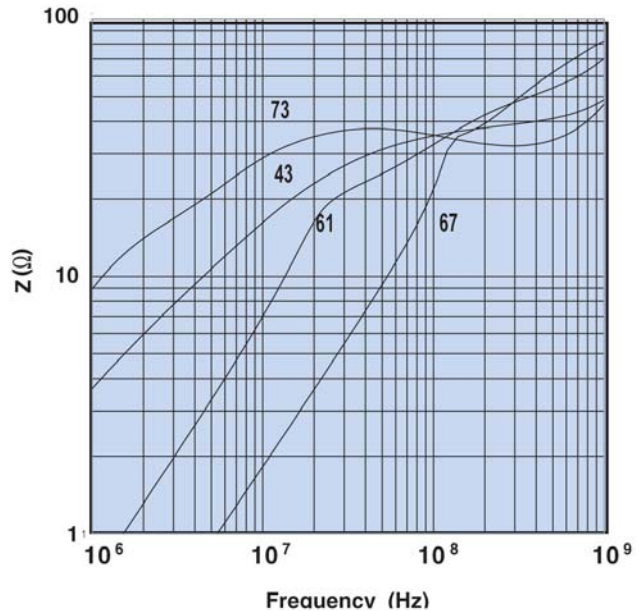

Figure 4 Impedance vs. frequency for part number 28—002302 in 73, 43, 61 & 67 material.

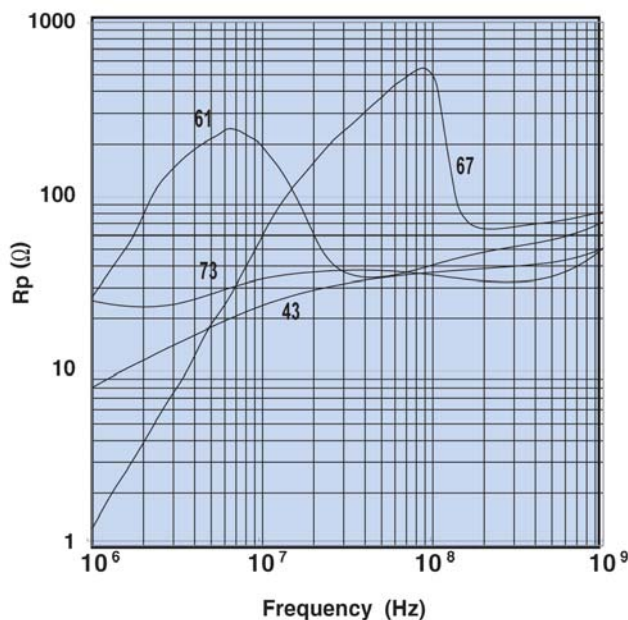

Figure 5 Parallel resistance vs. frequency for part number 28—002302 in 73, 43, 61 & 67 material.

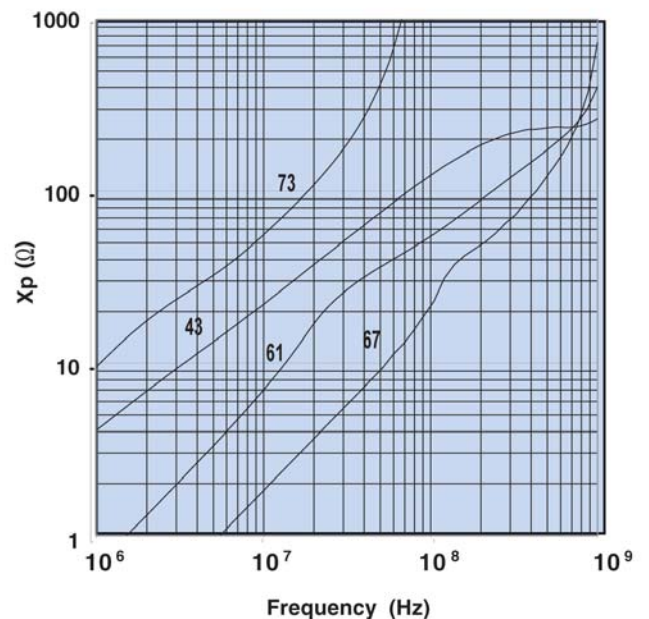

Figure 6 Parallel reactance vs. frequency for part number 28—002302 in 73, 43, 61 & 67 material.

How to Choose Ferrite Components for EMI Suppression

Introduction

The following pages will focus on Soft Ferrites used in the application of electromagnetic interference (EMI) suppression. Although the end use is an important issue and some applications are mentioned, this technical section is not intended to be a design manual, but rather, an aid to the designer in understanding and choosing the optimum ferrite material and component for their particular application. Ferrite suppressor cores are simple to use, in either initial designs or retrofits, and are comparatively economical in both price and space. Ferrite suppressors have been successfully employed for attenuating EMI in computers and related products, switching power supplies, electronic automotive ignition systems, and garage doors openers, to name just a few.

Use of Ferrite Suppressor Cores

The United States was one of the first countries to recognize the potential problems caused by electromagnetic pollution. As a result the FCC was charged with the responsibility of promulgating rules and regulations to control and enforce limits on high frequency interference.

Figure 1 shows the current radiation limits as defined by FCC Rules Part 15, for class A (industrial) and class B (mass-market) equipment.

Contrary to the times when these regulations were first enforced and designing for EMI protection was often an afterthought rather than a forethought, a major portion of today's circuitry is incorporating EMI safeguards in its initial design. Many approaches can be used to comply with design or specification limits for EMI. Attention to basic circuit design, component layout, shielded enclosures and other use of shielding materials may be considered. For reducing or eliminating conducted EMI on printed circuit boards in wiring and cables, ferrite components have been used very successfully for decades. The ferrite core introduces into the circuit a frequency variable impedance, see Figure 2. The core will not affect the lower frequency operating signals but does block the conduction of the EMI noise frequencies. The Figures 3 and 4 are photographs of a representative sampling of the Fair-Rite Products Corp. product line of suppressor cores.

| Conducted Limits* | | |
|-------------------|---------|---------|
| Frequency | Class A | Class B |
| 450 kHz – 1.6 MHz | 60 dBuV | 50 dBuV |
| 1.6 MHz – 30 MHz | 70 dBuV | 60 dBuV |

*Measured using a 50-ohm LISN

| Radiated Limits** | | |
|-------------------|-----------|-----------|
| Frequency | Class A | Class B |
| 30 MHz – 88 MHz | 50 dBuV/m | 40 dBuV/m |
| 88 MHz – 216 MHz | 53 dBuV/m | 43 dBuV/m |
| 216 MHz – 960 MHz | 56 dBuV/m | 46 dBuV/m |
| above 960 MHz | 64 dBuV/m | 54 dBuV/m |

**Measured at a 3-meter distance

Figure 1 FCC Radiation Limits for class A & B equipment.

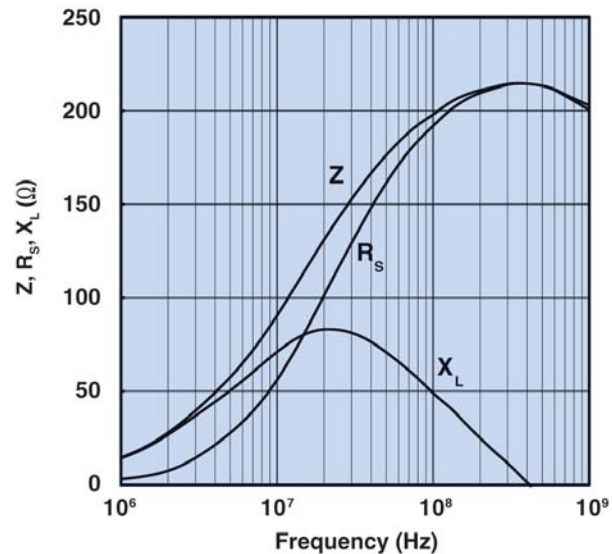

Figure 2 Impedance, reactance, and resistance vs. frequency for a ferrite core in 43 material.

Technical Information

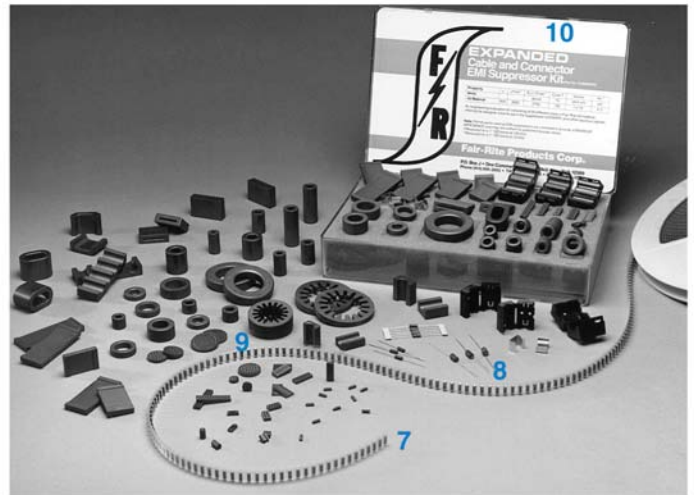
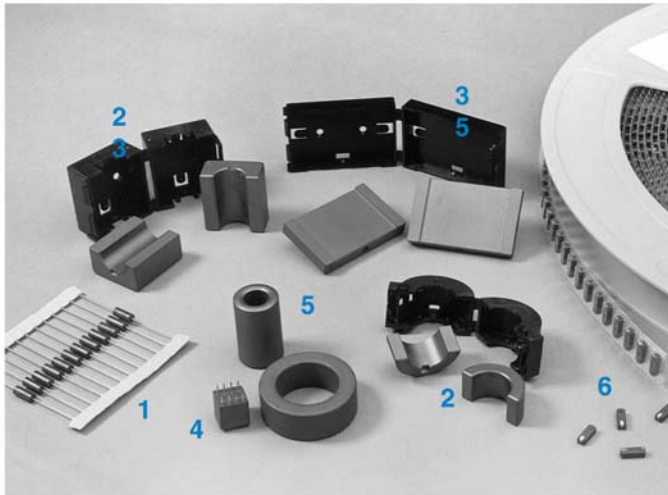

Figure 3, 4 Variety of EMI Suppression Cores including: (1) Beads on Leads, (2) Split Round Cable Suppression Cores and Cases, (3) Split Flat Cable Suppression Cores and Cases, (4) Printed Circuit (PC) Beads, (5) Round Cable Suppression Cores (6) Surface-Mount (SM) Beads, (7) on Reel, (8) Wound Beads, (9) Connector Suppression Discs and Plates and (10) One of our Engineering Kits containing a Large Variety of Samples of EMI Suppressor Cores.

The Magnetics

The permeability of a ferrite material is a complex parameter consisting of a real and an imaginary part. The real component represents the reactive portion and the imaginary component represents the losses. These may be expressed as series components (μ_s', μ_s'') or parallel components (μ_p', μ_p'').

Figure 5 is the vector representation of the series equivalent circuit of a ferrite suppression core; the loss free inductor (L_s) is in series with the equivalent loss resistor (R_s). The following equations relate the series impedance and the complex permeability:

$$Z = j\omega L_s + R_s = j\omega L_o(\mu_s' - j\mu_s'') \text{ ohm}$$

so that

$$\omega L_s = \omega L_o \mu_s' \text{ ohm}$$

$$R_s = \omega L_o \mu_s'' \text{ ohm}$$

where: $L_o = \frac{4\pi N^2 10^{-9}}{C_1}$ (H) is the air core inductance.

C_1 = core factor

The impedance of a ferrite suppressor core is a combination of the intrinsic material characteristics μ_s' and μ_s'' , the square of the turns and of the ferrite core. The complex permeability components μ_s' and μ_s'' vary as a function of frequency. The core geometry and the number of turns are frequency independent contributors to the overall impedance.

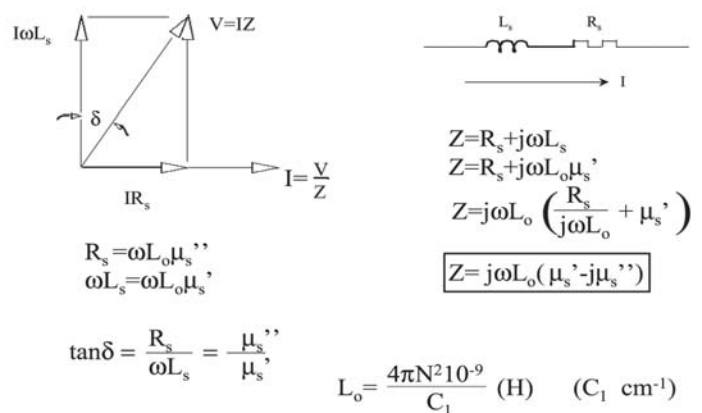

Figure 5

Material Selection

Conducted EMI can occur over a wide range of frequencies, from as low as 1 MHz to several GHz. To provide protection over such a wide frequency range a number of ferrite materials will have to be made available.

Fair-Rite offers a complete line of suppression ferrites that cover a gamut of frequencies. Starting at 1 MHz MnZn ferrites 73 and 31 are used. Beginning around 20 MHz up to 200/300 MHz the NiZn materials 43 and 44 and the MgZn 46 material are recommended. For the highest frequencies the NiZn 61 material is the choice.

Fair-Rite Products Corp. PO Box 288, One Commercial Row, Wallkill, NY 12589-0288

Phone: (888) FAIR RITE / (845) 895-2055 • Fax: (888) FERRITE / (845) 895-2629 • Web: www.fair-rite.com
(888) 324-7748 (888) 337-7483 E-mail: ferrites@fair-rite.com

Technical Information

Figures 6 through 11 show for these six suppression materials the complex permeabilities μ'_s and μ''_s as a function of frequency. For all these materials at low frequencies μ'_s is highest but as the frequency increases μ''_s becomes the dominant material parameter whence the biggest contributor to the overall impedance. At the low frequencies where μ'_s is highest the suppression core is mostly inductive and rejects EMI signals. At the higher frequencies where μ''_s becomes the more significant parameter the impedance will become more and more resistive and absorbs the conducted EMI.

Table 1 lists Fair-Rite's suppression materials, suggested operating frequency ranges and the test frequencies for the six suppression materials. The recommended materials will provide the highest combination of the primary material characteristics μ'_s and μ''_s over that frequency range.

Table 1

| Material | Frequency Range | Test Frequencies | Comments |
|----------|-----------------|-------------------|---------------------|
| 73 | 1 –25 MHz | 10 – 25 MHz | Small parts only |
| 31 | 1 – 300 MHz | 10 – 25 – 100 MHz | Large parts only |
| 43 | 20 – 300 MHz | 25 – 100 MHz | Wide range of parts |
| 44 | 20 – 300 MHz | 25 – 100 MHz | High resistivity |
| 46 | 20 - 300 MHz | 100 MHz | Large Parts |
| 61 | 200+ MHz | 250 - 500 MHz | For VHF designs |

Making the material selection is the first step in eliminating conducted EMI problems. To make this material selection it is imperative that the frequency or frequencies of the unwanted noise are known. This needs not be an exact figure; an approximation will be sufficient. From the EMI frequency the material can be selected. It should be made clear that several environmental conditions will have to be addressed before this selection becomes final.

Environmental Conditions

As shown in Figures 6 through 11, the μ'_s and μ''_s will vary as a function of frequency. However, several environmental conditions will also affect these primary material parameters. The most significant ones are temperature and dc bias.

Changes in the combination of μ'_s and μ''_s due to temperature is strictly a material characteristic which is not affected by the core geometry. The graphs in Figures 12 through 17 show the percentage change in impedance as a function of temperature when compared to room temperature. These typical changes in impedance will be applicable for all components made from these materials. Designers can use these graphs to evaluate performance of specific components versus temperature.

73 Material

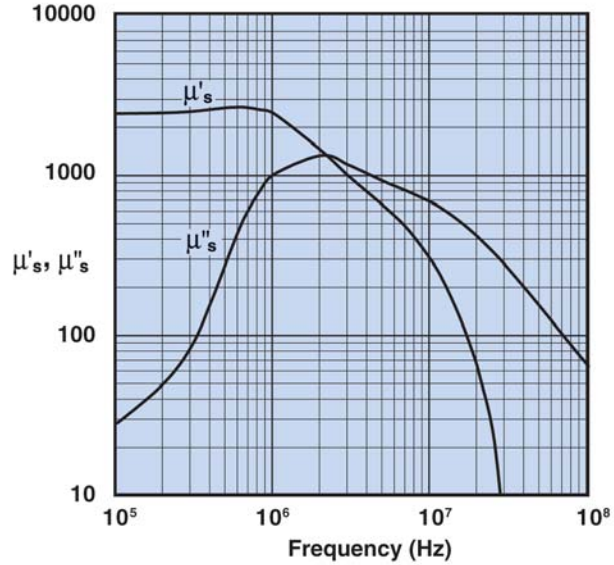

Figure 6 Complex Permeability vs. Frequency Measured on a 2673000301 bead using the HP 4284A and the HP 4291A.

31 Material

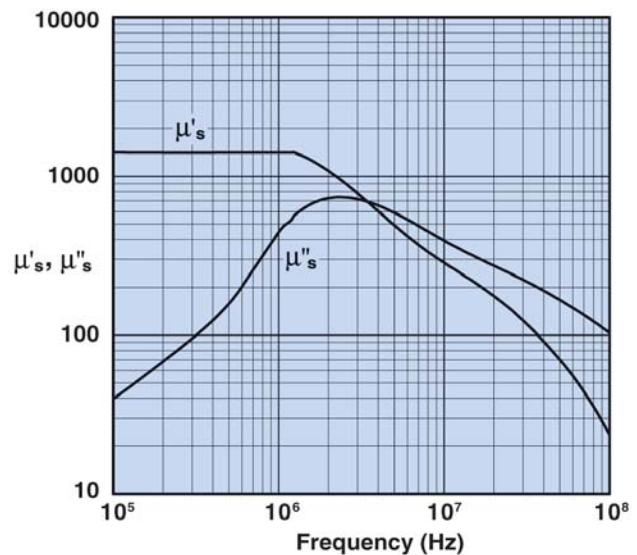

Figure 7 Complex Permeability vs. Frequency Measured on a 17/10/6mm toroid using the HP 4284A and the HP 4291A.

Technical Information

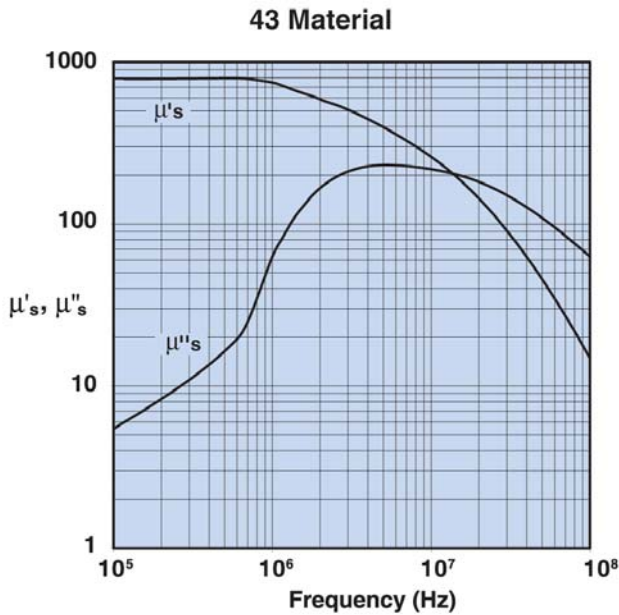

Figure 8 Complex Permeability vs. Frequency Measured on a 17/10/6mm toroid using the HP 4284A and the HP 4291A.

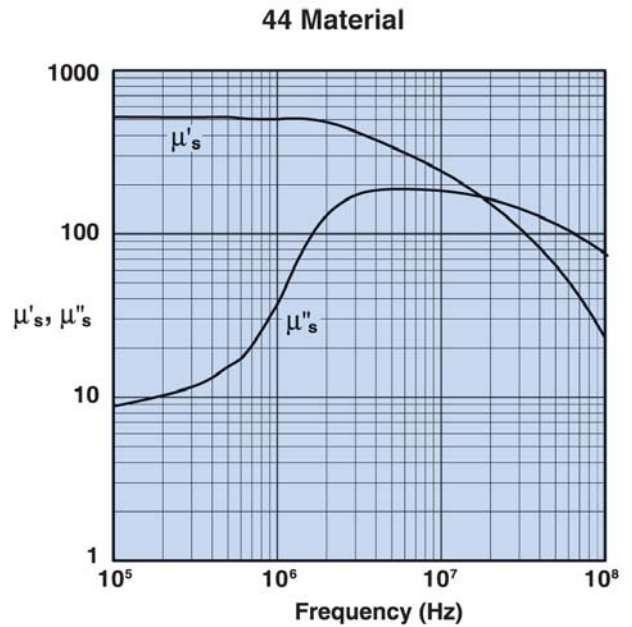

Figure 9 Complex Permeability vs. Frequency Measured on a 17/10/6mm toroid using the HP 4284A and the HP 4291A

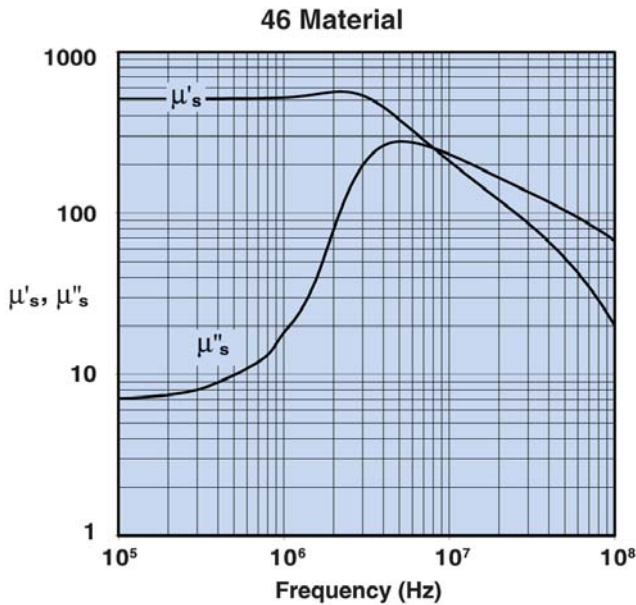

Figure 10 Complex Permeability vs. Frequency Measured on a 17/10/6mm toroid using the HP 4284A and the HP 4291A.

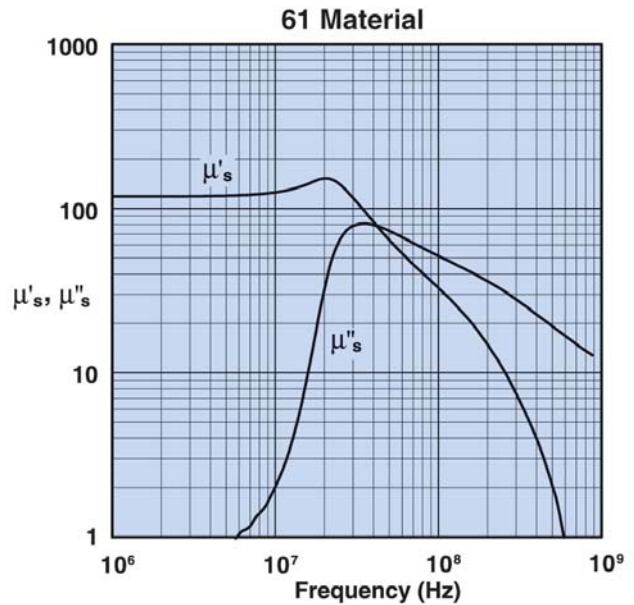

Figure 11 Complex Permeability vs. Frequency Measured on a 17/10/6mm toroid using the HP 4284A and the HP 4291A

Technical Information

The dc bias is more complex. The dc bias will affect both the μ'_s and μ''_s , but this is also influenced by the core geometry, specifically the magnetic path length. Therefore Fair-Rite provides dc bias information based on a dc H field in oersted for many of its suppression components. For all EMI suppression beads and round cable suppression cores listed in the catalog a calculated H value ($H=1.256/I_m$) that is based on a single turn and one Amp direct current is shown. This calculated value of H should be modified if more turns are used or if the current is not 1 A. A 2 Amp current will of course double the value listed for the part. Once the true dc H field is calculated, graphs in Figures 18 through 23 will provide the change in impedance information for the appropriate material, frequency and true H value.

Dc bias curves are included on the Fair-Rite CD-ROM. Also those components for which the magnetic path length cannot easily be calculated the dc bias curves are on the CD-ROM as well. Again, this will provide the designer with a quick evaluation on how the dc bias affects the performance of these components.

73 Material

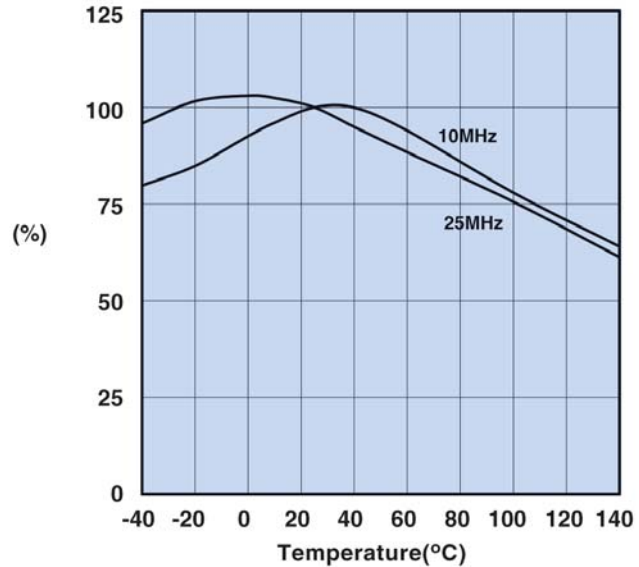

Figure 12 Percent of Original Impedance vs. Temperature Measured on a 2673000301 using the HP4291A.

31 Material

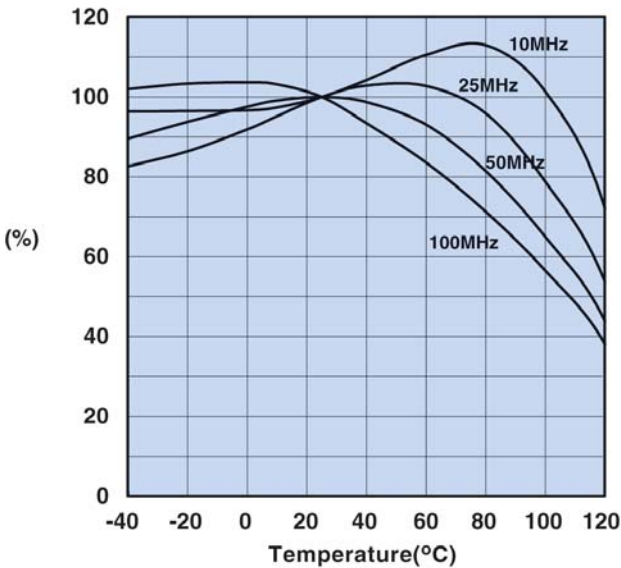

Figure 13 Percent of Original Impedance vs. Temperature Measured on a 2631000301 using the HP4291A.

43 Material

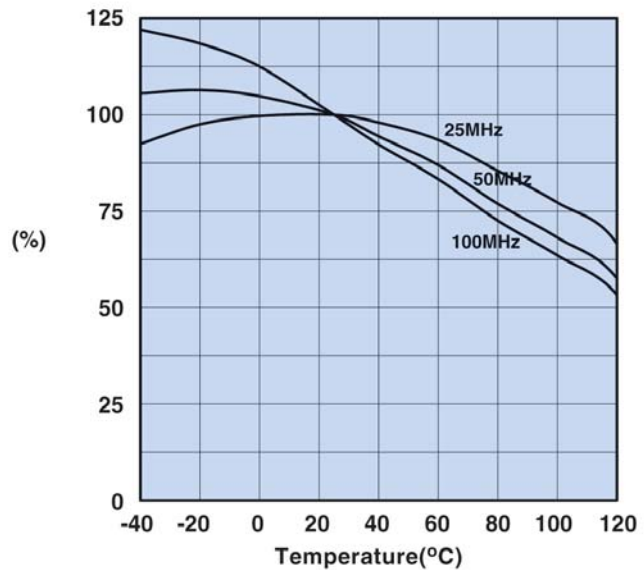

Figure 14 Percent of Original Impedance vs. Temperature Measured on a 2643000301 using the HP4291A.

Technical Information

44 Material

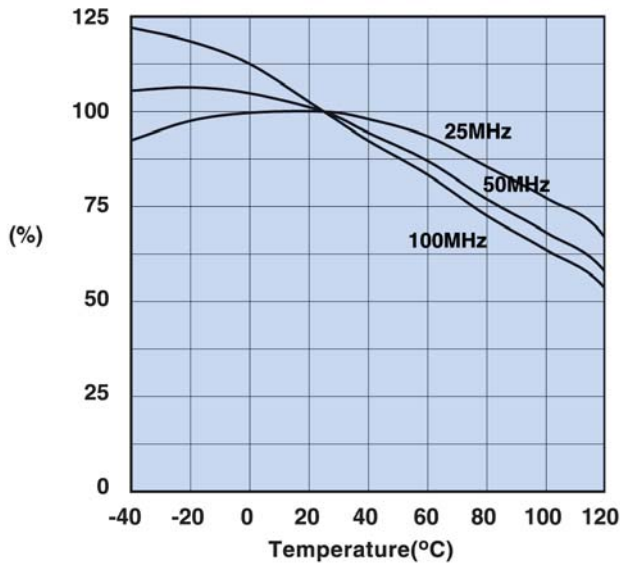

Figure 15 Percent of Original Impedance vs. Temperature Measured on a 2644000301 using the HP4291A.

46 Material

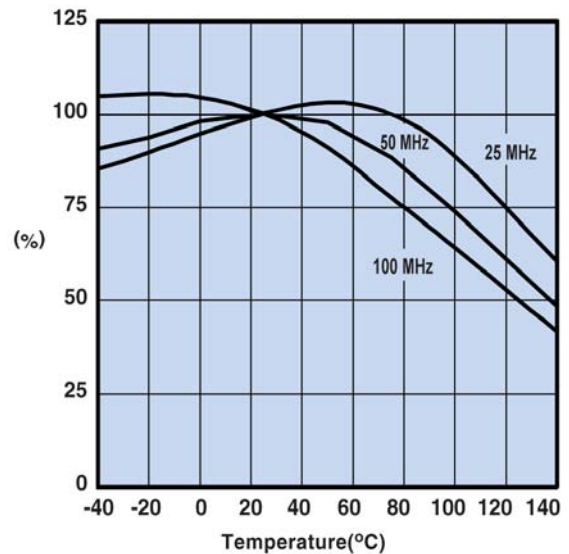

Figure 16 Percent of Original Impedance vs. Temperature Measured on a 2646000301 using the HP4291A.

61 Material

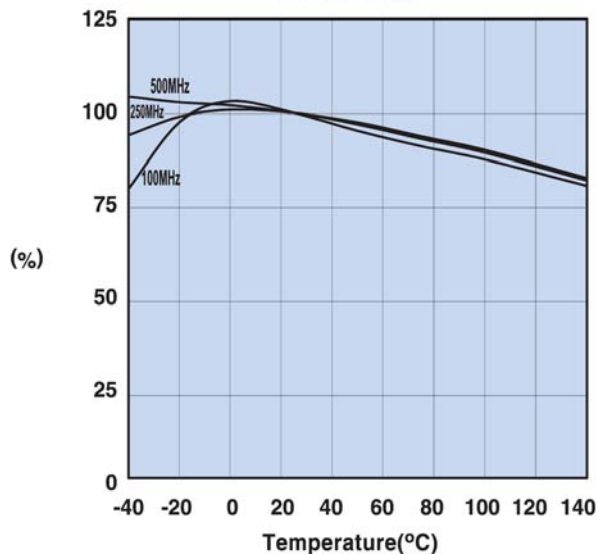

Figure 17 Percent of Original Impedance vs. Temperature Measured on a 2661000301 using the HP4291A.

Secondary Material Parameters

Although μ'_s and μ''_s are the most critical material characteristics for suppression applications, resistivity and Curie temperature are ferrite material parameters that should be considered as well.

The Curie temperature is the transition temperature above which the ferrite loses its magnetic properties. At this temperature the component is no longer performing its intended function. Once the material cools down below this temperature it will again perform as before. For all Fair-Rite materials a minimum Curie temperature is specified.

As mentioned previously, Fair-Rite manufactures three classes of ferrite materials, MnZn, NiZn and MgZn ferrites. The manganese zinc materials have low resistivities whereas the nickel zinc and magnesium zinc materials have high resistivities. For applications that use non-insulated wires or for use as connector suppression plates, a ferrite material with the highest resistivity is recommended. Fair-Rite's 44 material is an improved 43 material by providing both increased resistivity and Curie temperature. Components in the 44 NiZn material are catalog standard parts for connector plates and wound parts such as PC beads and wound beads.

Technical Information

73 Material

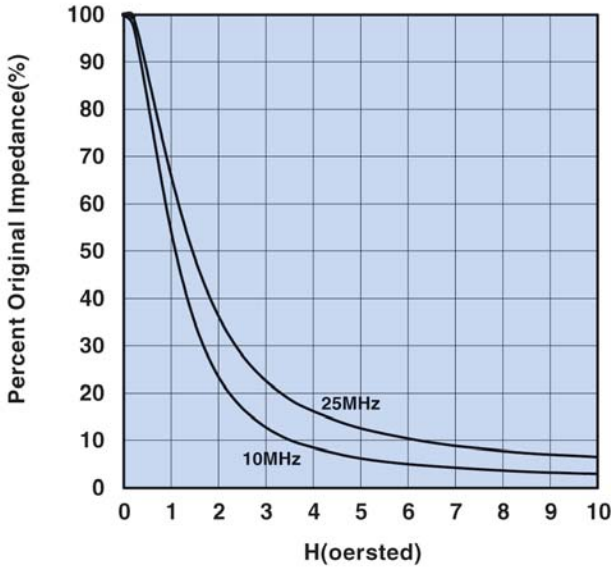

Figure 18 Percent of Original Impedance vs. Magnetic Field Strength. Measured on a 2673000301 using the HP4291A.

31 Material

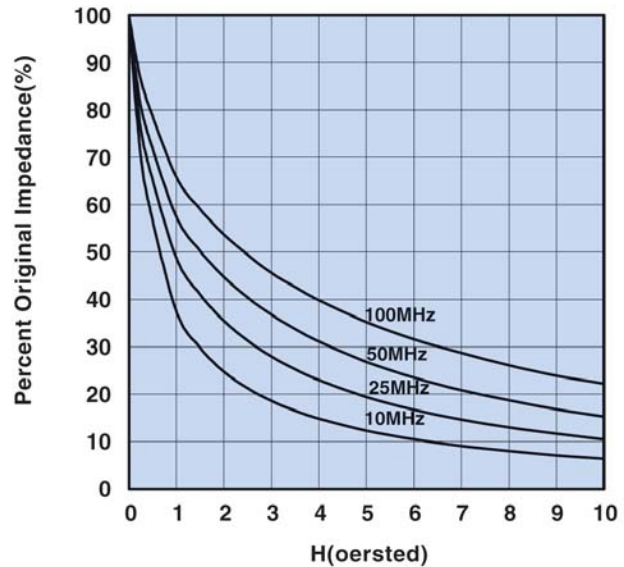

Figure 19 Percent of Original Impedance vs. Magnetic Field Strength. Measured on a 2631000301 using the HP4291A.

43 Material

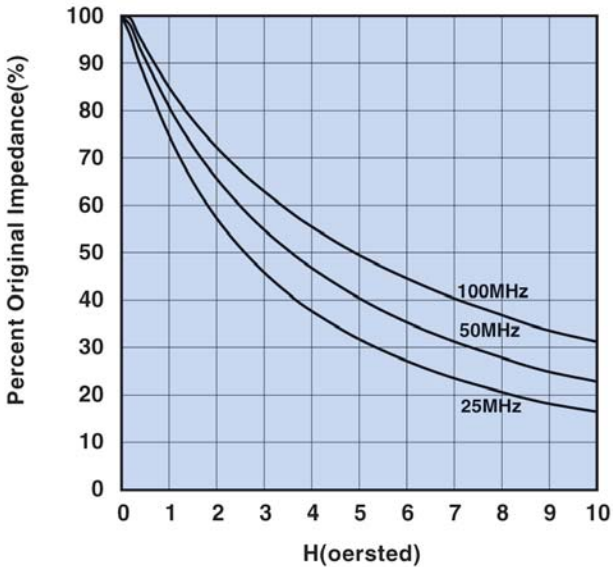

Figure 20 Percent of Original Impedance vs. Magnetic Field Strength. Measured on a 2643000301 using the HP4291A.

44 Material

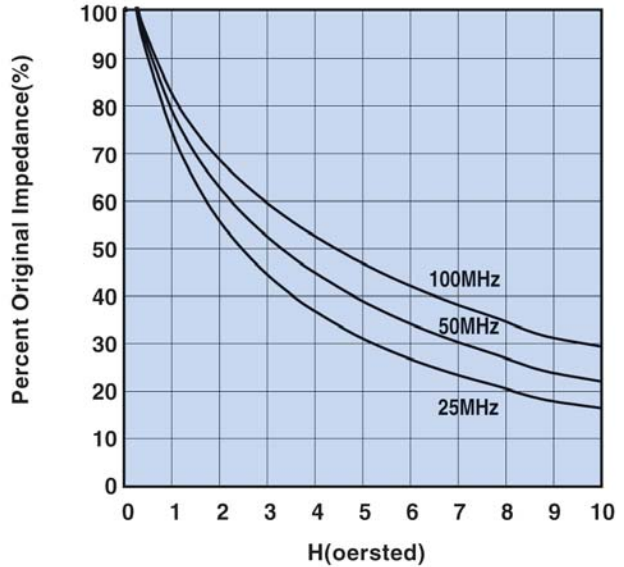

Figure 21 Percent of Original Impedance vs. Magnetic Field Strength. Measured on a 2644000301 using the HP4291A.

Technical Information

46 Material

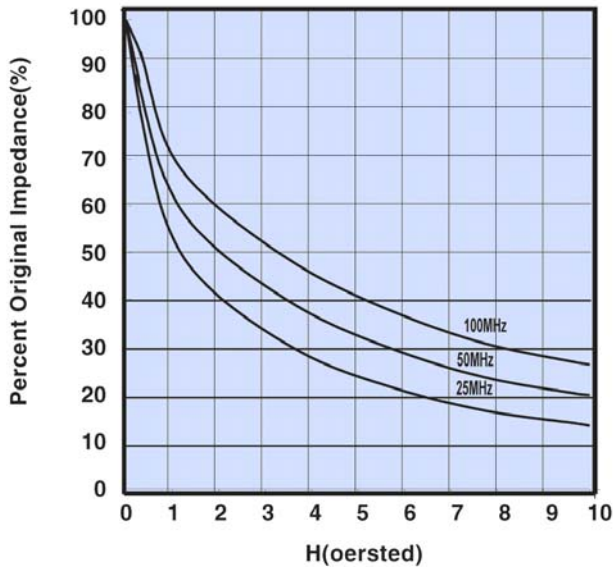

Figure 22 Percent of Original Impedance vs. Magnetic Field Strength. Measured on a 2646000301 using the HP4291A.

61 Material

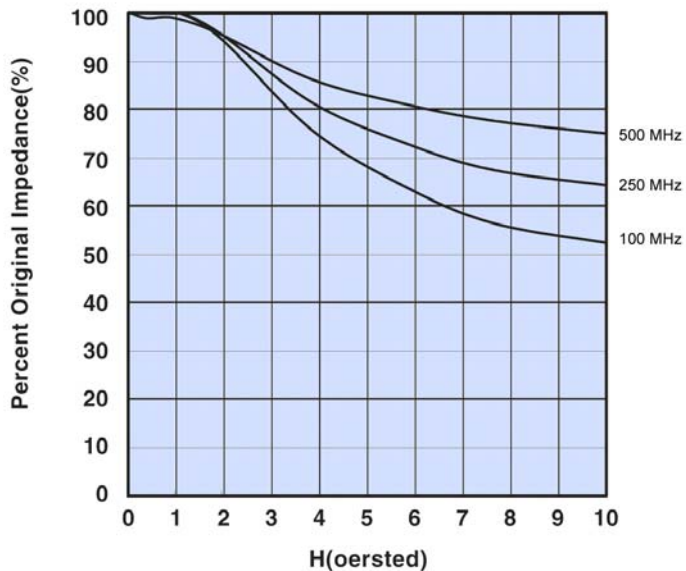

Figure 23 Percent of Original Impedance vs. Magnetic Field Strength. Measured on a 2661000301 using the HP4291A.

Common-Mode Design

If the dc currents are so high that the resulting impedances are not sufficient to suppress the conducted noise, the common-mode approach might solve the problem. As shown in Figure 24, in a common-mode design both current-carrying conductors will pass through the same hole in the core. The dc fields will cancel and the common-mode noise that is picked-up on both lines will be attenuated. It should be pointed out that an EMI signal that is on the line to the load and then returns from the load will not "see" the core and will not be attenuated.

In applications with a large direct current in a single conductor, the solution might be the use of an open magnetic circuit core such as a wound ferrite rod. In automotive designs where the ground is used as the return path, this often is the only option.

When high frequency operating signals, typically above 1 MHz, are susceptible to EMI, the common-mode approach might be used to solve that problem. In this instance common-mode is not used for the current compensation, but rather for the compensation of the high frequency signals. These signal pairs will be not be suppressed, yet any common-mode EMI will be attenuated. The use of round or flat cable cores is a good example of this application of this type of common-mode suppression.

Common-Mode Design

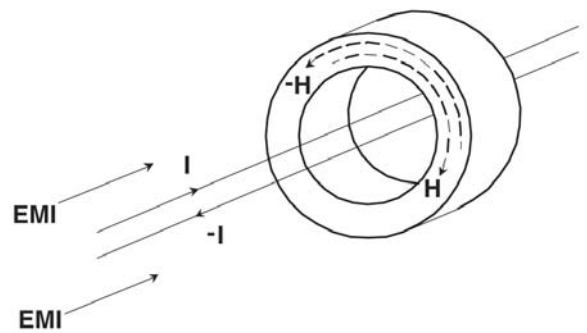

Figure 24

Technical Information

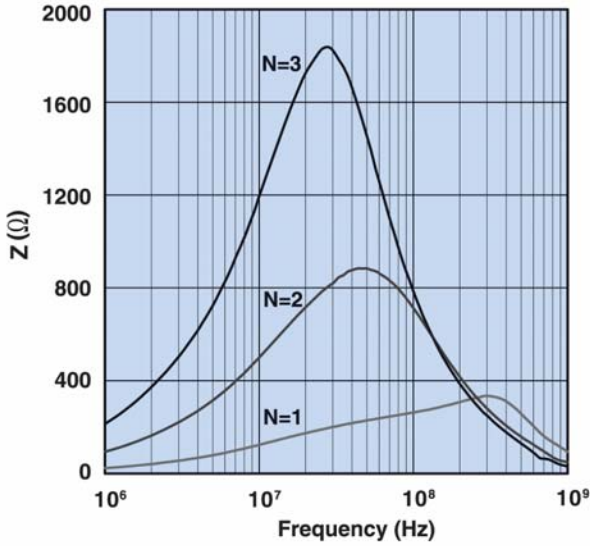

Figure 25 Impedance vs. frequency for a 14/6/28mm cable core in 43 material wound with one, two, and three turns.

Overall the process of selecting a bead or cable core that fits the wire or cable is mainly a mechanical evaluation, but the longer the selected core the higher the impedance for a given volume of ferrite material.

Suppression Materials

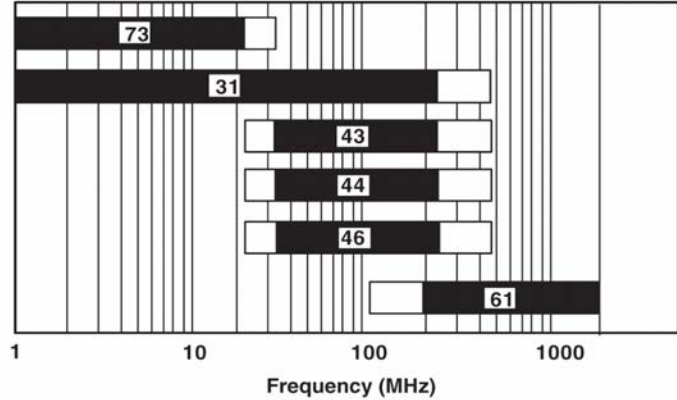

Figure 26 Available Fair-Rite Suppression Materials vs. Frequency

Core Selection

Once the proper ferrite material for a specific suppression application has been decided the required ferrite core is the next step in solving the EMI problem. The core contribution to the impedance is expressed in the formula

$$L_o = \frac{4\pi N^2 10^{-9}}{C_1} \text{ (H)}$$

From this formula it is evident that the impedance is proportional to the square of the number of turns and the core geometry shown by the core factor C_1 . The advantage of the proportionality of N^2 is often overlooked and yet can enhance the overall impedance significantly for a rather minor cost. Figure 25 shows the impedance versus frequency curves for one of Fair-Rite's 43 material cable cores wound with one, two and three turns. By increasing the number of turns the winding capacitance is increased resulting in a shift in the maximum impedance to lower frequencies. If an improvement of the low frequency impedance performance is needed, this increase in turns can be very beneficial for the 43 material applications.

The core geometry most often used in suppression applications is the toroidal core. When the dimensions are in inches, the L_o for the toroidal core shape is $1.17 N^2 H \log_{10} OD/ID 10^{-8}$ (H). Of the three core dimensions OD, ID and H (height), the H is the most significant. This dimension is proportional to the toroidal L_o and hence of the impedance of the core. Doubling H will double the volume and also the impedance. Doubling the core volume by changing the OD and or the ID will only increase the impedance by approximately 40%.

Suppressing Common-Mode Noise

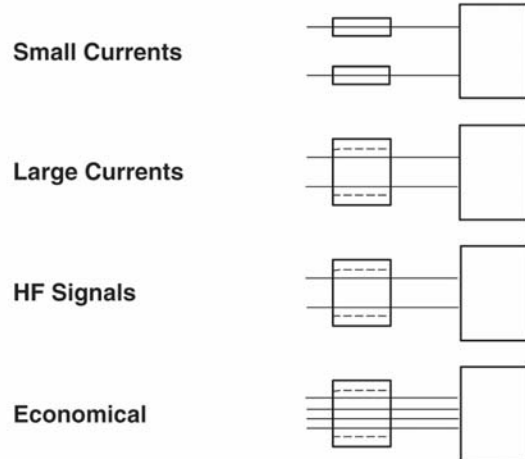

Figure 27

Suppressing Differential-Mode Noise

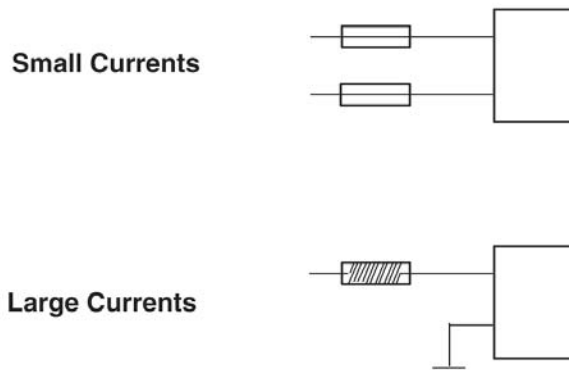

Figure 28

Summary

1. Material Selection

The graph in Figure 26 aids in the initial material selection for suppressing conducted EMI frequencies.

DC bias, core size, operating temperature and resistance requirements might affect this choice.

2. Core Selection

To make a final core selection, the type of EMI, common-mode or differential-mode, will affect the choice of the core configuration.

Figures 27 and 28 provide an overview of the available core shape options for different levels of input currents.

Although the catalog lists hundreds of suppression components, we at Fair-Rite Products Corp. will manufacture parts to fit customer specific applications. Contact one of our representatives or our sales office in Wallkill, NY with your requirements.

Part Number Index

| | | | | | |
|------------|----|---------------|----|----------------|----|
| 0 | | | | | |
| 0199000005 | 67 | 0446164951 | 82 | 2508055007Y0 | 60 |
| 0199000017 | 72 | 0446167251 | 82 | 2508056007Y0 | 61 |
| 0199000018 | 67 | 0446167281 | 82 | 2508056007Y3 | 62 |
| 0199000019 | 68 | 0446173551 | 82 | 2508056007Y6 | 63 |
| 0199000024 | 68 | 0446173951 | 82 | 2508056007Z0 | 61 |
| 0199000025 | 69 | 0446176451 | 82 | 2508056017Y0 | 61 |
| 0199000027 | 69 | 0461164181 | 83 | 2508056017Y2 | 62 |
| 0199000028 | 70 | 0461164281 | 82 | 2508059007Y0 | 61 |
| 0199000029 | 70 | 0461164951 | 82 | 2512061017Y0 | 61 |
| 0199000030 | 70 | 0461167281 | 83 | 2512061027Y0 | 61 |
| 0199000031 | 71 | 0461176451 | 83 | 2512061027Y0A4 | 65 |
| 0199000032 | 71 | 0461178181 | 82 | 2512061027Y1 | 62 |
| 0199000033 | 72 | 0461178281 | 82 | 2512061217Y0 | 61 |
| 0199000036 | 72 | 2 | | 2512061217Y0A4 | 65 |
| 0199000038 | 73 | 2504021007Y0 | 60 | 2512061217Y5 | 63 |
| 0199000039 | 73 | 2504021217Y0 | 60 | 2512061517Y3 | 62 |
| 0199001401 | 87 | 2504023017Y0 | 60 | 2512061527Y0 | 61 |
| 0199010301 | 87 | 2504026007Y0 | 60 | 2512063007Y0 | 61 |
| 0199016051 | 87 | 2504026017Y0 | 60 | 2512063007Y3 | 62 |
| 0199016551 | 87 | 2506030707H0 | 60 | 2512063017Y0 | 61 |
| 0431163951 | 88 | 2506031007H0 | 60 | 2512063017Y0A4 | 65 |
| 0431164051 | 88 | 2506031017Y0 | 60 | 2512063017Y3 | 62 |
| 0431164181 | 81 | 2506031027H0 | 60 | 2512065007Y0 | 61 |
| 0431164281 | 81 | 2506031027Y0 | 60 | 2512065007Y3 | 62 |
| 0431164951 | 81 | 2506031217H0 | 60 | 2512065007Y6 | 63 |
| 0431167281 | 81 | 2506031217Y0 | 60 | 2512066007Y0A4 | 65 |
| 0431173551 | 81 | 2506031217Y2 | 62 | 2512066017Y0 | 61 |
| 0431173951 | 81 | 2506031217Z0 | 60 | 2512066017Y0A4 | 65 |
| 0431176451 | 81 | 2506031517Y0 | 60 | 2512066017Y1 | 62 |
| 0431177081 | 81 | 2506032217H0 | 60 | 2512067007Y0 | 61 |
| 0431178181 | 81 | 2506033007Y0 | 60 | 2512067007Y3 | 62 |
| 0431178281 | 81 | 2506033007Y3 | 62 | 2512069007Y0 | 61 |
| 0443163951 | 88 | 2506033017Y0 | 60 | 2518061017Y0 | 61 |
| 0443164051 | 88 | 2506033017Z0 | 60 | 2518061017Y6 | 63 |
| 0443164151 | 81 | 2506033317H0 | 60 | 2518061517Y0 | 61 |
| 0443164251 | 81 | 25060336007Y0 | 60 | 2518065007Y6 | 63 |
| 0443166651 | 88 | 25060336007Y3 | 62 | 2518066007Y3 | 62 |
| 0443167251 | 81 | 2506036007Z0 | 60 | 2518068007Y3 | 62 |
| 0443178181 | 81 | 2506036017Y0 | 60 | 2518121217Y3 | 62 |
| 0443178281 | 81 | 2506038007Y0 | 60 | 2518121217Y6 | 63 |
| 0443625006 | 81 | 2508051017Y0 | 61 | 2518127007Y3 | 62 |
| 0443665806 | 81 | 2508051027Y0 | 61 | 2631023002 | 76 |
| 0443800506 | 82 | 2508051027Y1 | 62 | 2631101902 | 76 |
| 0443806406 | 82 | 2508051107Y0 | 60 | 2631102002 | 76 |
| 0444164181 | 82 | 2508051217Y0 | 61 | 2631103002 | 76 |
| 0444164281 | 81 | 2508051217Y3 | 62 | 2631163851 | 85 |
| 0444164951 | 81 | 2508051217Y6 | 63 | 2631163851 | 85 |
| 0444167281 | 81 | 2508051217Z0 | 61 | 2631164051 | 85 |
| 0444173551 | 82 | 2508051527Y0 | 61 | 2631181381 | 81 |
| 0444173951 | 81 | 2508051817Y0 | 61 | 2631250202 | 76 |
| 0444176451 | 82 | 2508052027Y1 | 62 | 2631480002 | 76 |
| 0444177081 | 82 | 2508052027Z0 | 61 | 2631480102 | 76 |
| 0446164151 | 82 | 2508053007Y0 | 60 | 2631540002 | 76 |
| 0446164181 | 82 | 2508053007Y3 | 62 | 2631540202 | 76 |
| 0446164251 | 82 | 2508053017Y0 | 61 | 2631625002 | 76 |
| 0446164281 | 82 | 2508053017Y3 | 62 | 2631625102 | 76 |
| | | 2508053017Z0 | 61 | 2631626202 | 76 |
| | | | | 2631626302 | 76 |
| | | | | 2631626402 | 76 |
| | | | | 2631665702 | 76 |
| | | | | 2631801202 | 76 |
| | | | | 2631803802 | 76 |
| | | | | 2631814002 | 76 |
| | | | | 2643000101 | 37 |
| | | | | 2643000201 | 37 |
| | | | | 2643000301 | 37 |
| | | | | 2643000501 | 37 |
| | | | | 2643000701 | 37 |
| | | | | 2643000801 | 37 |
| | | | | 2643001301 | 37 |
| | | | | 2643001501 | 37 |
| | | | | 2643001601 | 37 |
| | | | | 2643002201 | 37 |
| | | | | 2643002402 | 38 |
| | | | | 2643003201 | 37 |
| | | | | 2643004601 | 37 |
| | | | | 2643004701 | 37 |
| | | | | 2643004801 | 37 |
| | | | | 2643005701 | 37 |
| | | | | 2643006302 | 37 |
| | | | | 2643012702 | 38 |
| | | | | 2643013801 | 37 |
| | | | | 2643020501 | 37 |
| | | | | 2643021801 | 37 |
| | | | | 2643022401 | 37 |
| | | | | 2643023002 | 38 |
| | | | | 2643023201 | 37 |
| | | | | 2643023402 | 37 |
| | | | | 2643025601 | 37 |
| | | | | 2643101902 | 77 |
| | | | | 2643102002 | 77 |
| | | | | 2643102402 | 77 |
| | | | | 2643103002 | 78 |
| | | | | 2643163851 | 85 |
| | | | | 2643163951 | 86 |
| | | | | 2643164051 | 86 |
| | | | | 2643164551 | 85 |
| | | | | 2643165151 | 91 |
| | | | | 2643166451 | 86 |
| | | | | 2643166551 | 86 |
| | | | | 2643166651 | 86 |
| | | | | 2643166851 | 85 |
| | | | | 2643167551 | 86 |
| | | | | 2643167751 | 86 |
| | | | | 2643167851 | 91 |
| | | | | 2643168051 | 86 |
| | | | | 2643168251 | 86 |
| | | | | 2643168351 | 86 |
| | | | | 2643168651 | 85 |
| | | | | 2643168751 | 85 |
| | | | | 2643169351 | 85 |
| | | | | 2643169552 | 85 |
| | | | | 2643170251 | 85 |
| | | | | 2643170951 | 86 |
| | | | | 2643171051 | 85 |
| | | | | 2643172551 | 85 |
| | | | | 2643173351 | 85 |
| | | | | 2643173851 | 85 |
| | | | | 2643175451 | 91 |
| | | | | 2643178351 | 85 |
| | | | | 2643178551 | 85 |
| | | | | 2643178651 | 85 |
| | | | | 2643178751 | 85 |
| | | | | 2643180251 | 85 |
| | | | | 2643180351 | 85 |
| | | | | 2643180451 | 85 |
| | | | | 2643180551 | 86 |
| | | | | 2643180651 | 86 |
| | | | | 2643180751 | 86 |
| | | | | 2643180851 | 85 |
| | | | | 2643200101 | 37 |
| | | | | 2643250202 | 37 |
| | | | | 2643250302 | 37 |
| | | | | 2643250402 | 37 |
| | | | | 2643251002 | 77 |
| | | | | 2643300101 | 37 |
| | | | | 2643375002 | 37 |
| | | | | 2643375102 | 37 |
| | | | | 2643480002 | 77 |
| | | | | 2643480102 | 77 |
| | | | | 2643540002 | 77 |
| | | | | 2643540102 | 77 |
| | | | | 2643540202 | 77 |
| | | | | 2643540302 | 77 |
| | | | | 2643540402 | 77 |
| | | | | 2643540702 | 77 |
| | | | | 2643625002 | 77 |
| | | | | 2643625102 | 77 |
| | | | | 2643625202 | 77 |
| | | | | 2643625902 | 78 |
| | | | | 2643626002 | 78 |
| | | | | 2643626102 | 78 |
| | | | | 2643626202 | 78 |
| | | | | 2643626302 | 77 |
| | | | | 2643626402 | 77 |
| | | | | 2643626502 | 77 |
| | | | | 2643665702 | 77 |
| | | | | 2643665802 | 77 |
| | | | | 2643665902 | 77 |
| | | | | 2643800302 | 77 |
| | | | | 2643800502 | 77 |
| | | | | 2643800602 | 77 |
| | | | | 2643801002 | 78 |
| | | | | 2643801102 | 77 |
| | | | | 2643801202 | 78 |
| | | | | 2643801402 | 77 |
| | | | | 2643801502 | 77 |
| | | | | 2643801802 | 77 |
| | | | | 2643801902 | 77 |
| | | | | 2643802702 | 78 |
| | | | | 2643803802 | 78 |
| | | | | 2643804502 | 78 |

Fair-Rite Products Corp. PO Box 288, One Commercial Row, Walkill, NY 12589-0288

Part Number Index

| | | | | | | | | | |
|------------|----|------------|----|------------|----|------------|----|------------|----|
| 2643806402 | 77 | 2673000801 | 36 | 2743021447 | 53 | 2752555576 | 54 | 2773044446 | 52 |
| 2643814002 | 78 | 2673001601 | 36 | 2743037446 | 53 | 2752555576 | 54 | 2773044447 | 52 |
| 2644181281 | 82 | 2673002201 | 36 | 2743037446 | 53 | 2752555577 | 54 | 2773044447 | 52 |
| 2644236001 | 90 | 2673002402 | 36 | 2743037447 | 53 | 2752555577 | 54 | 2843000102 | 48 |
| 2644236101 | 90 | 2673003201 | 36 | 2743037447 | 53 | 2761001111 | 41 | 2843000202 | 48 |
| 2644236301 | 90 | 2673004601 | 36 | 2744040446 | 53 | 2761001112 | 41 | 2843000302 | 48 |
| 2644236401 | 90 | 2673004701 | 36 | 2744040446 | 53 | 2761002111 | 41 | 2843001502 | 48 |
| 2644236501 | 90 | 2673004801 | 36 | 2744040447 | 53 | 2761002112 | 41 | 2843001802 | 48 |
| 2644236601 | 90 | 2673004901 | 36 | 2744040447 | 53 | 2761004111 | 41 | 2843002302 | 48 |
| 2644245701 | 90 | 2673012401 | 36 | 2744041446 | 56 | 2761004112 | 41 | 2843002402 | 48 |
| 2644246201 | 90 | 2673015301 | 36 | 2744041446 | 56 | 2761007111 | 41 | 2843002702 | 48 |
| 2644246701 | 90 | 2673018001 | 36 | 2744041447 | 56 | 2761007112 | 41 | 2843006802 | 48 |
| 2644247001 | 90 | 2673021801 | 36 | 2744041447 | 56 | 2761008111 | 41 | 2843009902 | 48 |
| 2644247101 | 90 | 2673022401 | 36 | 2744044446 | 53 | 2761008112 | 41 | 2843010302 | 48 |
| 2644373841 | 90 | 2673025301 | 36 | 2744044446 | 53 | 2761009111 | 41 | 2843010402 | 48 |
| 2644373941 | 90 | 2673028602 | 36 | 2744044447 | 53 | 2761009112 | 41 | 2861000102 | 49 |
| 2644666611 | 45 | 2673030101 | 36 | 2744044447 | 53 | 2761015111 | 41 | 2861000202 | 49 |
| 2644777711 | 45 | 2673200201 | 36 | 2744045446 | 56 | 2761015112 | 41 | 2861000302 | 49 |
| 2646101902 | 78 | 2673901301 | 36 | 2744045446 | 56 | 2761019446 | 54 | 2861001502 | 49 |
| 2646102002 | 78 | 2675023002 | 75 | 2744045447 | 56 | 2761019446 | 54 | 2861001702 | 49 |
| 2646102402 | 78 | 2675102002 | 76 | 2744045447 | 56 | 2761019447 | 54 | 2861002302 | 49 |
| 2646480002 | 78 | 2675540002 | 75 | 2744051446 | 56 | 2761019447 | 54 | 2861002402 | 49 |
| 2646480102 | 78 | 2675540202 | 75 | 2744051446 | 56 | 2761021446 | 54 | 2861002702 | 49 |
| 2646540002 | 78 | 2675625102 | 75 | 2744051447 | 56 | 2761021446 | 54 | 2861006802 | 49 |
| 2646540202 | 78 | 2675626402 | 76 | 2744051447 | 56 | 2761021447 | 54 | 2861010002 | 49 |
| 2646625002 | 78 | 2675665702 | 75 | 2744065446 | 56 | 2761021447 | 54 | 2867000102 | 49 |
| 2646625102 | 78 | 2675821502 | 76 | 2744065446 | 56 | 2773001111 | 39 | 2867000302 | 49 |
| 2646625202 | 78 | 2677006302 | 91 | 2744065447 | 56 | 2773001112 | 39 | 2867001502 | 49 |
| 2646626202 | 79 | 2677102402 | 91 | 2744065447 | 56 | 2773002111 | 40 | 2867002302 | 49 |
| 2646626402 | 78 | 2743001111 | 40 | 2744555566 | 54 | 2773002112 | 40 | 2867002402 | 49 |
| 2646665702 | 78 | 2743001112 | 40 | 2744555566 | 53 | 2773003111 | 39 | 2867002702 | 49 |
| 2646665802 | 78 | 2743002111 | 40 | 2744555567 | 53 | 2773003112 | 39 | 2867006802 | 49 |
| 2646803802 | 79 | 2743002112 | 40 | 2744555567 | 53 | 2773004111 | 40 | 2873000102 | 48 |
| 2646804502 | 78 | 2743003111 | 40 | 2744555576 | 54 | 2773004112 | 39 | 2873000202 | 48 |
| 2661000101 | 38 | 2743003112 | 40 | 2744555576 | 53 | 2773005111 | 39 | 2873000302 | 48 |
| 2661000301 | 38 | 2743004111 | 40 | 2744555577 | 54 | 2773005112 | 39 | 2873001502 | 48 |
| 2661000701 | 38 | 2743004112 | 40 | 2744555577 | 53 | 2773007111 | 40 | 2873001702 | 48 |
| 2661000801 | 38 | 2743005111 | 40 | 2752041446 | 57 | 2773007112 | 40 | 2873001802 | 48 |
| 2661021801 | 38 | 2743005112 | 40 | 2752041446 | 57 | 2773008111 | 40 | 2873002302 | 48 |
| 2661022401 | 38 | 2743007111 | 40 | 2752041447 | 57 | 2773008112 | 40 | 2873002402 | 48 |
| 2661023801 | 38 | 2743007112 | 40 | 2752041447 | 57 | 2773009111 | 40 | 2873002702 | 48 |
| 2661102002 | 79 | 2743008111 | 40 | 2752045446 | 57 | 2773009112 | 40 | 2873006802 | 48 |
| 2661102402 | 79 | 2743008112 | 40 | 2752045446 | 57 | 2773015111 | 39 | 2944666631 | 45 |
| 2661250402 | 38 | 2743009111 | 41 | 2752045447 | 57 | 2773015112 | 39 | 2944666631 | 45 |
| 2661375102 | 38 | 2743009112 | 41 | 2752045447 | 57 | 2773019446 | 52 | 2944666634 | 45 |
| 2661480002 | 79 | 2743012201 | 41 | 2752051446 | 57 | 2773019446 | 52 | 2944666634 | 46 |
| 2661540002 | 79 | 2743013211 | 41 | 2752051446 | 57 | 2773019447 | 52 | 2944666651 | 45 |
| 2661540202 | 79 | 2743014221 | 41 | 2752051447 | 57 | 2773019447 | 52 | 2944666651 | 45 |
| 2661626402 | 79 | 2743015111 | 40 | 2752051447 | 57 | 2773021446 | 52 | 2944666654 | 45 |
| 2661665702 | 79 | 2743015112 | 40 | 2752065446 | 57 | 2773021446 | 52 | 2944666654 | 45 |
| 2661666611 | 45 | 2743019446 | 53 | 2752065446 | 57 | 2773021447 | 52 | 2944666661 | 45 |
| 2661801902 | 79 | 2743019446 | 53 | 2752065447 | 57 | 2773021447 | 52 | 2944666661 | 45 |
| 2673000101 | 36 | 2743019447 | 53 | 2752065447 | 57 | 2773037446 | 52 | 2944666671 | 45 |
| 2673000201 | 36 | 2743019447 | 53 | 2752555566 | 54 | 2773037446 | 52 | 2944666671 | 45 |
| 2673000301 | 36 | 2743021446 | 53 | 2752555566 | 54 | 2773037447 | 52 | 2944666681 | 45 |
| 2673000501 | 36 | 2743021446 | 53 | 2752555567 | 54 | 2773037447 | 52 | 2944666681 | 45 |
| 2673000701 | 36 | 2743021447 | 53 | 2752555567 | 54 | 2773044446 | 52 | 2944770301 | 43 |

Fair-Rite Products Corp. PO Box 288, One Commercial Row, Walkill, NY 12589-0288

Phone: (888) FAIR RITE / (845) 895-2055 • Fax: (888) FERRITE / (845) 895-2629 • Web: www.fair-rite.com
 (888) 324-7748 (888) 337-7483 E-mail: ferrites@fair-rite.com

Part Number Index

| | | | | | | | | | |
|------------|----|------------|-----|------------|-----|------------|-----|------------|-----|
| 2944776101 | 43 | 4052098411 | 93 | 5698221421 | | 5943006421 | 106 | 5967003801 | 103 |
| 2944777721 | 46 | 4052111011 | 93 | 5695221421 | | 5943007601 | 106 | 5967003821 | 103 |
| 2944777721 | 45 | 4052155611 | 93 | 5678221421 | 114 | 5943011101 | 106 | 5968000201 | 102 |
| 2944777741 | 46 | 4052195211 | 93 | 5698221421 | | 5943011121 | 106 | 5968000301 | 102 |
| 2944777741 | 45 | 4052235211 | 93 | 5695221421 | | 5943015901 | 106 | 5968001101 | 102 |
| 2944778101 | 43 | 4052251111 | 93 | 5678261721 | 115 | 5943017301 | 106 | 5968001801 | 102 |
| 2944778301 | 43 | 4061266011 | 93 | 5698261721 | | 5943017501 | 106 | 5968002701 | 103 |
| 2952776101 | 43 | 4061272011 | 93 | 5695261721 | | 5943018601 | 106 | 5968003801 | 103 |
| 2952778301 | 43 | 4061276011 | 93 | 5678261721 | 114 | 5952003801 | 105 | 5968020901 | 102 |
| 2961666631 | 46 | 4061287011 | 93 | 5698261721 | | 5952020201 | 104 | 5968021001 | 102 |
| 2961666631 | 46 | 4061375411 | 93 | 5695261721 | | 5952020301 | 104 | 5975000101 | 108 |
| 2961666634 | 46 | 4061378111 | 93 | 5678302021 | 115 | 5952020401 | 104 | 5975000201 | 108 |
| 2961666634 | 46 | 4077122011 | 94 | 5698302021 | | 5952020501 | 104 | 5975000211 | 109 |
| 2961666651 | 46 | 4077172011 | 94 | 5695302021 | | 5952020601 | 105 | 5975000221 | 109 |
| 2961666651 | 46 | 4077266011 | 94 | 5678302021 | 114 | 5952020701 | 105 | 5975000301 | 109 |
| 2961666654 | 46 | 4077272011 | 94 | 5698302021 | | 5952020801 | 105 | 5975000321 | 109 |
| 2961666654 | 46 | 4077276011 | 94 | 5695302021 | | 5961000101 | 103 | 5975000501 | 109 |
| 2961666661 | 46 | 4077292011 | 94 | 5678362321 | 114 | 5961000111 | 103 | 5975000601 | 109 |
| 2961666661 | 46 | 4077296011 | 94 | 5698362321 | | 5961000201 | 103 | 5975000621 | 109 |
| 2961666671 | 46 | 4077312911 | 94 | 5695362321 | | 5961000211 | 103 | 5975000801 | 108 |
| 2961666671 | 46 | 4077374711 | 94 | 5678362321 | 115 | 5961000221 | 103 | 5975001101 | 109 |
| 2961666681 | 46 | 4077375211 | 94 | 5698362321 | | 5961000301 | 103 | 5975001121 | 109 |
| 2961666681 | 46 | 4077375411 | 94 | 5695362321 | | 5961000321 | 104 | 5975001401 | 109 |
| 3 | | 4077484611 | 94 | 5943000101 | 105 | 5961000501 | 104 | 5975001801 | 109 |
| 3061990821 | 98 | 4077485111 | 94 | 5943000111 | 105 | 5961000601 | 104 | 5975001821 | 109 |
| 3061990831 | 98 | 4078375111 | 94 | 5943000201 | 105 | 5961000621 | 104 | 5975001901 | 109 |
| 3061990841 | 98 | 4078377511 | 94 | 5943000211 | 105 | 5961000801 | 103 | 5975002101 | 108 |
| 3061990851 | 98 | 4277142009 | 94 | 5943000221 | 105 | 5961000811 | 103 | 5975002701 | 109 |
| 3061990861 | 98 | 4277242409 | 94 | 5943000301 | 105 | 5961000811 | 103 | 5975002701 | 109 |
| 3061990871 | 98 | 4277352509 | 94 | 5943000321 | 105 | 5961001001 | 104 | 5975003801 | 109 |
| 3061990881 | 98 | 4277353509 | 94 | 5943000501 | 105 | 5961001021 | 104 | 5975003821 | 109 |
| 3061990891 | 98 | 4278282509 | 94 | 5943000521 | 105 | 5961001101 | 104 | 5975004901 | 109 |
| 3061990901 | 98 | 4278453509 | 94 | 5943000601 | 105 | 5961001121 | 104 | 5975004921 | 109 |
| 3061990911 | 98 | 5 | | 5943000621 | 105 | 5961001201 | 104 | 5975005101 | 109 |
| 3067990821 | 97 | 5678090621 | 115 | 5943000801 | 105 | 5961001221 | 104 | 5975006401 | 109 |
| 3067990831 | 97 | 5698090621 | | 5943000901 | 105 | 5961001701 | 104 | 5975007601 | 109 |
| 3067990841 | 97 | 5695090621 | | 5943000911 | 105 | 5961001721 | 104 | 5975007621 | 109 |
| 3067990851 | 97 | 5678090621 | 114 | 5943001001 | 106 | 5961001801 | 104 | 5975011101 | 109 |
| 3067990861 | 97 | 5698090621 | | 5943001021 | 106 | 5961001821 | 104 | 5975011121 | 109 |
| 3067990871 | 97 | 5695090621 | | 5943001101 | 105 | 5961001901 | 104 | 5975021921 | 109 |
| 3067990881 | 97 | 5678110821 | 114 | 5943001121 | 105 | 5961001921 | 104 | 5975022021 | 109 |
| 3078990821 | 98 | 5698110821 | | 5943001201 | 106 | 5961002701 | 104 | 5976000101 | 110 |
| 3078990831 | 98 | 5695110821 | | 5943001301 | 106 | 5961002721 | 104 | 5976000201 | 110 |
| 3078990841 | 98 | 5678110821 | 115 | 5943001401 | 106 | 5961003801 | 104 | 5976000211 | 110 |
| 3078990841 | 98 | 5698110821 | | 5943001421 | 106 | 5961003821 | 104 | 5976000221 | 110 |
| 3078990851 | 98 | 5695110821 | | 5943001601 | 106 | 5961004901 | 104 | 5976000801 | 110 |
| 3078990861 | 98 | 5678140921 | 114 | 5943001701 | 106 | 5961004921 | 104 | 5976011121 | 110 |
| 3078990871 | 98 | 5698140921 | | 5943001801 | 105 | 5967000101 | 103 | 5976022021 | 110 |
| 3078990881 | 98 | 5695140921 | | 5943001821 | 106 | 5967000201 | 103 | 5976022121 | 110 |
| 3078990891 | 98 | 5678140921 | 115 | 5943001901 | 105 | 5967000301 | 103 | 5977000101 | 106 |
| 3078990901 | 98 | 5698140921 | | 5943001921 | 105 | 5967000601 | 103 | 5977000201 | 106 |
| 3078990911 | 98 | 5695140921 | | 5943002701 | 106 | 5967001001 | 103 | 5977000211 | 106 |
| 4 | | 5678181221 | 115 | 5943002721 | 106 | 5967001101 | 103 | 5977000221 | 107 |
| 4033122011 | 94 | 5698181221 | | 5943003801 | 106 | 5967001201 | 103 | 5977000301 | 107 |
| 4033129021 | 94 | 5695181221 | | 5943003821 | 106 | 5967001701 | 103 | 5977000321 | 107 |
| 4033266011 | 94 | 5678181221 | 114 | 5943004901 | 105 | 5967001801 | 103 | 5977000501 | 107 |
| 4033276011 | 94 | 5698181221 | | 5943004921 | 105 | 5967001901 | 103 | 5977000601 | 107 |
| 4052077111 | 93 | 5695181221 | | 5943005101 | 105 | 5967002701 | 103 | 5977000621 | 107 |
| | | 5678221421 | 115 | 5943006401 | 106 | | | | |

Fair-Rite Products Corp. PO Box 288, One Commercial Row, Wallkill, NY 12589-0288

Part Number Index

| | | | | | | | | | |
|------------|-----|------------|-----|------------|-----|------------|-----|------------|-----|
| 5977001001 | 107 | 6278140121 | 116 | 6598200121 | | 7898400121 | | 8998303021 | |
| 5977001021 | 107 | 6298140121 | | 6595200121 | | 7895400121 | | 8995303021 | |
| 5977001101 | 107 | 6295140121 | | 6678211621 | 119 | 7878400221 | 113 | 9 | |
| 5977001121 | 107 | 6278180121 | 117 | 6698211621 | | 7898400221 | | 9077002002 | 129 |
| 5977001201 | 107 | 6298180121 | | 6695211621 | | 7895400221 | | 9077002002 | 128 |
| 5977001221 | 107 | 6295180121 | | 6678211621 | 118 | 7878400221 | 112 | 9077024002 | 128 |
| 5977001301 | 107 | 6278180121 | 116 | 6698211621 | | 7898400221 | | 9077024002 | 129 |
| 5977001321 | 107 | 6298180121 | | 6695211621 | | 7895400221 | | 9077025002 | 129 |
| 5977001401 | 107 | 6295180121 | | 6678212021 | 119 | 7878400321 | 113 | 9077025002 | 128 |
| 5977001421 | 107 | 6278230121 | 117 | 6698212021 | | 7898400321 | | 9077026002 | 129 |
| 5977001601 | 107 | 6298230121 | | 6695212021 | | 7895400321 | | 9077026002 | 128 |
| 5977001621 | 107 | 6295230121 | | 6678212021 | 118 | 7878400321 | 112 | 9277002002 | 128 |
| 5977001701 | 107 | 6278230121 | 116 | 6698212021 | | 7898400321 | | 9277002002 | 129 |
| 5977001721 | 108 | 6298230121 | | 6695212021 | | 7895400321 | | 9277008002 | 128 |
| 5977001801 | 107 | 6295230121 | | 6678272021 | 119 | 7878400421 | 113 | 9277008002 | 129 |
| 5977001821 | 107 | 6278280121 | 117 | 6698272021 | | 7898400421 | | 9277008002 | 129 |
| 5977001901 | 107 | 6298280121 | | 6695272021 | | 7895400421 | | 9277010002 | 128 |
| 5977001921 | 107 | 6295280121 | | 6678272021 | 118 | 7878400421 | 112 | 9277010002 | 129 |
| 5977002701 | 108 | 6278280121 | 116 | 6698272021 | | 7898400421 | | 9277012002 | 129 |
| 5977002721 | 108 | 6298280121 | | 6695272021 | | 7895400421 | | 9277012002 | 128 |
| 5977003801 | 108 | 6295280121 | | 6678272521 | 118 | 7878400721 | 113 | 9277023002 | 129 |
| 5977003821 | 108 | 6278370121 | 116 | 6698272521 | | 7898400721 | | 9277023002 | 128 |
| 5977004901 | 107 | 6298370121 | | 6695272521 | | 7895400721 | | 9277024002 | 128 |
| 5977005101 | 107 | 6295370121 | | 6678272521 | 119 | 7878400721 | 112 | 9277024002 | 129 |
| 5977006401 | 107 | 6278370121 | 117 | 6698272521 | | 7898400721 | | 9478101002 | 120 |
| 5977007601 | 107 | 6298370121 | | 6695272521 | | 7895400721 | | 9498101002 | |
| 5977007601 | 107 | 6295370121 | | 6678322121 | 119 | 8 | | 9478101002 | 121 |
| 5977011101 | 108 | 6278420121 | 117 | 6698322121 | | 8978101021 | 122 | 9498101002 | |
| 5977011121 | 108 | 6298420121 | | 6695322121 | | 8998101021 | | 9478102002 | 120 |
| 5978001201 | 107 | 6295420121 | | 6678322121 | 118 | 8995101021 | | 9478102002 | 121 |
| 5978001221 | 107 | 6278420121 | 116 | 6698322121 | | 8978101021 | 123 | 9478102002 | 121 |
| 5978001701 | 108 | 6298420121 | | 6695322121 | | 8998101021 | | 9498102002 | |
| 5978001721 | 108 | 6295420121 | | 6678323121 | 119 | 8995101021 | | 9478103002 | 121 |
| 5978002101 | 106 | 6578070121 | 131 | 6698323121 | | 8978121221 | 123 | 9478103002 | 121 |
| 5978002701 | 108 | 6598070121 | | 6695323121 | | 8998121221 | | 9498103002 | |
| 5978002721 | 108 | 6595070121 | | 6678323121 | 118 | 8995121221 | | 9495103002 | |
| 5978003801 | 108 | 6578070121 | 130 | 6698323121 | | 8978121221 | 122 | 9478103002 | 120 |
| 5978003821 | 108 | 6598070121 | | 6695323121 | | 8998121221 | | 9498103002 | |
| 5978007601 | 107 | 6595070121 | | 6678353621 | 118 | 8995121221 | | 9478104002 | 120 |
| 5978007621 | 107 | 6578100121 | 131 | 6698353621 | | 8978151521 | 122 | 9478104002 | 121 |
| 5978008001 | 108 | 6598100121 | | 6695353621 | | 8998151521 | | 9498104002 | |
| 5978011101 | 108 | 6595100121 | | 6678353621 | 119 | 8995151521 | | 9478104002 | 121 |
| 5978014001 | 108 | 6578100121 | 130 | 6698353621 | | 8978151521 | 123 | 9478104002 | 121 |
| 5978015901 | 108 | 6598100121 | | 6695353621 | | 8998151521 | | 9478105002 | 121 |
| 5978017301 | 108 | 6595100121 | | 6678404121 | 119 | 8995151521 | | 9498105002 | |
| 5978017321 | 108 | 6578130121 | 131 | 6698404121 | | 8978202021 | 122 | 9478105002 | 120 |
| 5978018601 | 108 | 6598130121 | | 6695404121 | | 8998202021 | | 9498105002 | |
| 5978018701 | 108 | 6595130121 | | 6678404121 | 118 | 8995202021 | | 9478110002 | 121 |
| 5978018721 | 108 | 6578130121 | 130 | 6698404121 | | 8978202021 | 123 | 9498110002 | |
| | | 6598130121 | | 6695404121 | | 8998202021 | | 9495110002 | |
| | | 6595130121 | | 6678505021 | 119 | 8995202021 | | 9478110002 | 120 |
| 6 | | 6578170121 | 131 | 6698505021 | | 8978252521 | 122 | 9478110002 | 121 |
| 6278110121 | 117 | 6598170121 | | 6695505021 | | 8998252521 | | 9498110002 | |
| 6298110121 | | 6578170121 | 130 | 6678505021 | 118 | 8995252521 | | 9495110002 | |
| 6295110121 | | 6598170121 | | 6698505021 | | 8978252521 | 123 | 9478111002 | 121 |
| 6278110121 | 116 | 6595170121 | | 6695505021 | | 8998252521 | | 9498111002 | |
| 6298110121 | | 6578200121 | 131 | 7 | | 8995252521 | | 9495111002 | |
| 6295110121 | | 6598200121 | | 7878400121 | 112 | 8978303021 | 122 | 9478111002 | 120 |
| 6278140121 | 117 | 6598200121 | | 7898400121 | | 8998303021 | | 9498111002 | |
| 6298140121 | | 6595200121 | | 7895400121 | | 8995303021 | | 9495111002 | |
| 6295140121 | | 6578200121 | 130 | 7878400121 | 113 | 8978303021 | 123 | 9478112002 | 121 |
| | | | | | | | | 9498112002 | |

Fair-Rite Products Corp. PO Box 288, One Commercial Row, Wallkill, NY 12589-0288

Phone: (888) FAIR RITE / (845) 895-2055 • Fax: (888) FERRITE / (845) 895-2629 • Web: www.fair-rite.com
 (888) 324-7748 (888) 337-7483 E -mail: ferrites@fair-rite.com

Part Number Index

| | | | | | | | |
|------------|-----|------------|-----|------------|-----|------------|-----|
| 9495112002 | | 9495207002 | | 9578404602 | 127 | 9677282009 | 100 |
| 9478112002 | 120 | 9578100502 | 112 | 9598404602 | | 9677282009 | 101 |
| 9498112002 | | 9598100502 | | 9595404602 | | 9677282509 | 101 |
| 9495112002 | | 9595100502 | | 9578404602 | 126 | 9677282509 | 100 |
| 9478114002 | 121 | 9578100502 | 113 | 9598404602 | | 9677352509 | 101 |
| 9498114002 | | 9598100502 | | 9595404602 | | 9677352509 | 100 |
| 9478114002 | 120 | 9595100502 | | 9578424402 | 127 | 9677353509 | 100 |
| 9498114002 | | 9578110502 | 112 | 9598424402 | | 9677353509 | 101 |
| 9478115002 | 120 | 9598110502 | | 9595424402 | | 9677453509 | 100 |
| 9498115002 | | 9595110502 | | 9578424402 | 126 | 9677453509 | 101 |
| 9478115002 | 121 | 9578110502 | 113 | 9598424402 | | 9843000104 | 100 |
| 9498115002 | | 9598110502 | | 9595424402 | | 9843000104 | 100 |
| 9478116002 | 120 | 9595110502 | | 9578444502 | 125 | 9877000104 | 101 |
| 9498116002 | | 9578150602 | 112 | 9598444502 | | 9877000104 | 100 |
| 9478116002 | 121 | 9598150602 | | 9595444502 | | 9877000204 | 101 |
| 9498116002 | | 9578150602 | 113 | 9598444502 | 124 | 9877000204 | 100 |
| 9478117002 | 121 | 9598150602 | | 9595444502 | | | |
| 9498117002 | | 9578150602 | 113 | 9578494902 | 125 | | |
| 9478117002 | 120 | 9598150602 | | 9598494902 | | | |
| 9498117002 | | 9595150602 | | 9595494902 | | | |
| 9478201002 | 113 | 9578261802 | 127 | 9578494902 | 124 | | |
| 9498201002 | | 9598261802 | | 9598494902 | | | |
| 9495201002 | | 9595261802 | | 9595494902 | | | |
| 9478201002 | 112 | 9578261802 | 126 | 9578495402 | 127 | | |
| 9498201002 | | 9598261802 | | 9598495402 | | | |
| 9495201002 | | 9595261802 | | 9595495402 | | | |
| 9478202002 | 113 | 9578282802 | 127 | 9578495402 | 126 | | |
| 9498202002 | | 9598282802 | | 9598495402 | | | |
| 9495202002 | | 9595282802 | | 9595495402 | | | |
| 9478202002 | 112 | 9578282802 | 126 | 9578545402 | 124 | | |
| 9498202002 | | 9598282802 | | 9598545402 | | | |
| 9495202002 | | 9595282802 | | 9595545402 | | | |
| 9478203002 | 113 | 9578283402 | 126 | 9578545402 | 125 | | |
| 9498203002 | | 9598283402 | | 9598545402 | | | |
| 9495203002 | | 9595283402 | | 9595545402 | | | |
| 9478203002 | 112 | 9578283402 | 127 | 9578606002 | 124 | | |
| 9498203002 | | 9598283402 | | 9598606002 | | | |
| 9495203002 | | 9595283402 | | 9595606002 | | | |
| 9478204002 | 113 | 9578293202 | 124 | 9578606002 | 125 | | |
| 9498204002 | | 9598293202 | | 9598606002 | | | |
| 9495204002 | | 9595293202 | | 9595606002 | | | |
| 9478204002 | 112 | 9578293202 | 125 | 9643001015 | 100 | | |
| 9498204002 | | 9598293202 | | 9643001015 | 100 | | |
| 9495204002 | | 9595293202 | | 9643001165 | 100 | | |
| 9478205002 | 113 | 9578343502 | 124 | 9643001165 | 100 | | |
| 9498205002 | | 9598343502 | | 9677001015 | 100 | | |
| 9495205002 | | 9595343502 | | 9677001015 | 101 | | |
| 9478205002 | 112 | 9578343502 | 125 | 9677001165 | 101 | | |
| 9498205002 | | 9598343502 | | 9677001165 | 100 | | |
| 9495205002 | | 9595343502 | | 9677142009 | 101 | | |
| 9478206002 | 112 | 9578354202 | 126 | 9677142009 | 100 | | |
| 9498206002 | | 9598354202 | | 9677182009 | 101 | | |
| 9495206002 | | 9595354202 | | 9677182009 | 100 | | |
| 9478206002 | 113 | 9578354202 | 127 | 9677182009 | 100 | | |
| 9498206002 | | 9598354202 | | 9677182209 | 100 | | |
| 9495206002 | | 9595354202 | | 9677182209 | 101 | | |
| 9478207002 | 112 | 9578394002 | 124 | 9677242009 | 101 | | |
| 9498207002 | | 9598394002 | | 9677242009 | 100 | | |
| 9495207002 | | 9595394002 | | 9677242409 | 101 | | |
| 9478207002 | 113 | 9578394002 | 125 | 9677242409 | 100 | | |
| 9498207002 | | 9598394002 | | | | | |
| | | 9595394002 | | | | | |

Fair-Rite Products Corp. PO Box 288, One Commercial Row, Wallkill, NY 12589-0288

For Your Notes

Visit our website at:
www.fair-rite.com

Fair-Rite Products Corp. PO Box 288, One Commercial Row, Wallkill, NY 12589-0288

Phone: (888) FAIR RITE / (845) 895-2055 • Fax: (888) FERRITE / (845) 895-2629 • Web: www.fair-rite.com
(888) 324-7748 (888) 337-7483 E-mail: ferrites@fair-rite.com

For Your Notes

Visit our website at:
www.fair-rite.com

Fair-Rite Products Corp. PO Box 288, One Commercial Row, Walkill, NY 12589-0288

160 Phone: (888) FAIR RITE / (845) 895-2055 • Fax: (888) FERRITE / (845) 895-2629 • Web: www.fair-rite.com
(888) 324-7748 (888) 337-7483 E-mail: ferrites@fair-rite.com



Fair-Rite Products Corp. offers a comprehensive line of ferrite components in a wide range of materials and geometries for EMI Suppression, Power Applications, and RFID Antennas.

Fair-Rite is the first US soft ferrite manufacturer to receive ISO/TS 16949 certification. We place the highest value on quality, engineering, and service and are dedicated to continual improvement.

In addition to our standard product offering, Fair-Rite can provide custom designs and shapes to meet your specific requirements. We have an experienced team of engineers to assist you with new design and technical support.

Please visit our website at www.fair-rite.com. You can browse our online catalog by product category or search by part number. You will also find contact information for customer service, applications engineers, local sales representatives, and local distributors. A navigation tutorial is available to help guide you through our website.

Fair-Rite Products Corp.

P.O. Box 288, One Commercial Row, Wallkill, NY 12589-0288

Web: www.fair-rite.com

Mouser Electronics

Authorized Distributor

Click to View Pricing, Inventory, Delivery & Lifecycle Information:

Fair-Rite:

| | | | | | | | |
|-----------------------------------|-----------------------------------|-----------------------------------|-----------------------------------|-----------------------------------|-----------------------------------|-----------------------------------|-----------------------------------|
| <u>5976000211</u> | <u>5943000501</u> | <u>5943001301</u> | <u>5943001401</u> | <u>5943001601</u> | <u>5943001901</u> | <u>5943018601</u> | <u>5961004101</u> |
| <u>5977002501</u> | <u>5968002701</u> | <u>5968003801</u> | <u>5968001801</u> | <u>5967003801</u> | <u>5975002701</u> | <u>5975011101</u> | <u>5943000901</u> |
| <u>5967001001</u> | <u>5961000811</u> | <u>5978007601</u> | <u>5978008001</u> | <u>5961001501</u> | <u>5967000301</u> | <u>5967001901</u> | <u>5967002701</u> |
| <u>5975007601</u> | <u>5977000201</u> | <u>5977001201</u> | <u>5977001401</u> | <u>5977001801</u> | <u>5977006401</u> | <u>5961000621</u> | <u>5961001201</u> |
| <u>5975000601</u> | <u>5975001101</u> | <u>5975001401</u> | <u>5975001821</u> | <u>5976000201</u> | <u>5977000501</u> | <u>5978002101</u> | <u>5978001201</u> |
| <u>5977001301</u> | <u>5943014001</u> | <u>5952020701</u> | <u>5978018701</u> | <u>5979001801</u> | <u>5979000201</u> | <u>5979001001</u> | <u>5975002101</u> |
| <u>5952020401</u> | <u>5979021201</u> | <u>5967001201</u> | <u>5952020201</u> | <u>5977005101</u> | <u>5952020301</u> | <u>5975000101</u> | <u>5979002701</u> |
| <u>5975005101</u> | <u>5975000501</u> | <u>5961000801</u> | <u>5975006401</u> | <u>5943001201</u> | <u>5952020501</u> | <u>5978011101</u> | <u>5977004901</u> |
| <u>5943005101</u> | <u>5978002701</u> | <u>5967000101</u> | <u>5977000601</u> | <u>5977007601</u> | <u>5978001701</u> | <u>5978017301</u> | <u>5943002511</u> |