

- ◆ Small Insertion Loss
- ◆ High Isolation
- ◆ High Power Handling

■ Applications

- High Power Antenna Switch (25W output two-way radio)

■ General Description

The XB15A402 PIN diode employs a high reliability glass package that is designed for solid state antenna switches used in commercial two-way radios.

■ Dimensions

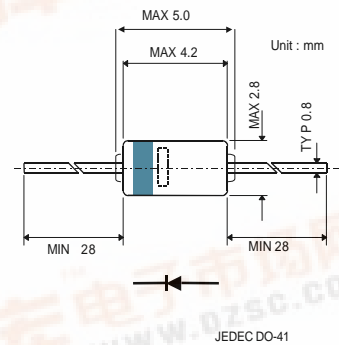

■ Absolute Maximum Ratings

Ta=25°C

SYMBOL	PARAMETER	RATINGS	UNITS
V <sub>RM</sub>	Repetitive Peak Reverse Voltage	270	V
I <sub>FSM</sub> *	Forward Surge Current	2	A
P	Power Dissipation	1	W
T <sub>j</sub>	Junction Temperature	175	°C
T <sub>stg</sub>	Storage Temperature	-55 to 175	°C

\* t = 5sec

■ Electrical characteristics

Ta=25°C

SYMBOL	PARAMETER	TEST CONDITIONS	LIMITS			UNITS
			MIN	TYP	MAX	
IR1	Reverse Current	V <sub>R</sub> = 270V			10	μA
IR2		V <sub>R</sub> = 200V			150	nA
I <sub>F</sub>	Forward Current	V <sub>F</sub> = 1.0V	500			mA
C <sub>t</sub>	Diode Capacitance	V <sub>R</sub> = 12V, f = 1MHz		2.0	3.0	pF
r <sub>fs</sub>	Forward Series Resistance	I <sub>F</sub> = 50mA, f = 470MHz		0.5	0.7	Ω
f <sub>c</sub>	Cut-off Frequency	V <sub>R</sub> = 12V, f = 50MHz	1.0			GHz

## Electrical Characteristics

Forward Current vs. Forward Voltage

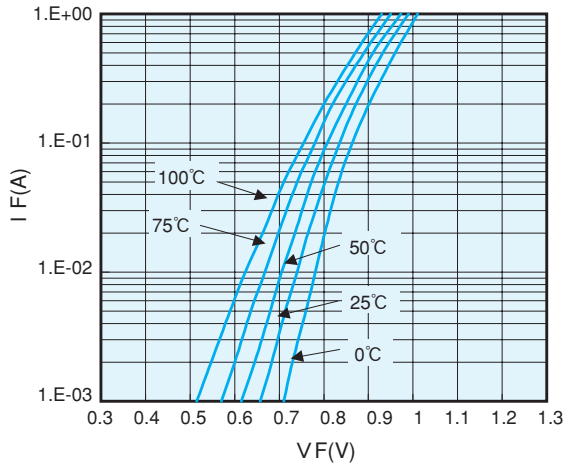

Reverse Current vs. Reverse Voltage

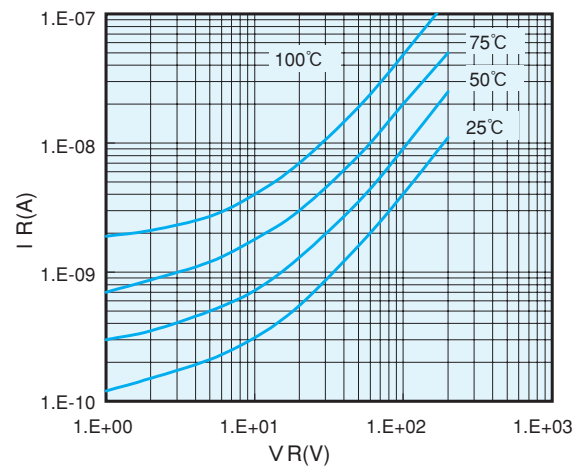

Forward Series Resistance vs. Forward Current

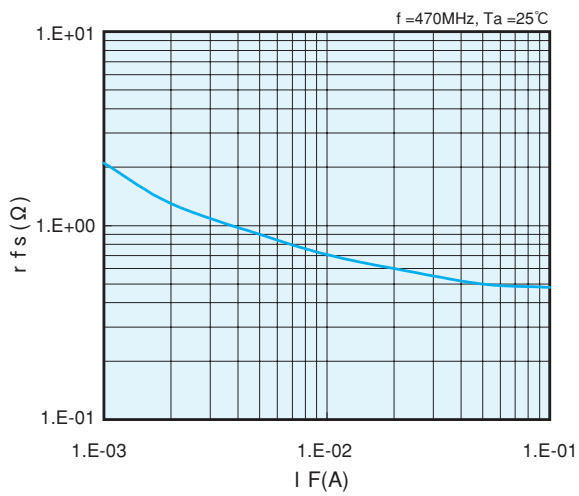

Diode Capacitance vs. Reverse Voltage

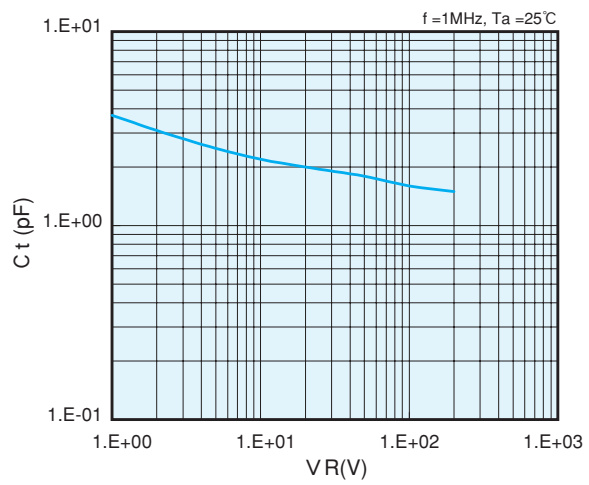

Q vs. Reverse Voltage

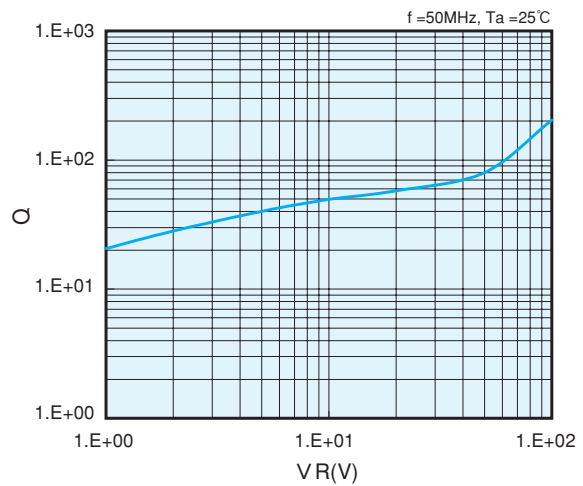

Ordering Information

WIDTH (mm)	TYPE	MINIMUM ORDER UNIT	ORDERING
26	Taping	2000 pcs./ Ammo Pack Box	XB15A****GT
52	Taping	2000 pcs./ Ammo Pack Box	XB15A****GT
52	Taping Reel	5000 pcs./ Reel	XB15A****GR
52	Bulk	100 pcs./ Bag x 10 Bags	XB15A****GB
12	Embossed tape	1500 pcs./ Reel	XB15A****HR

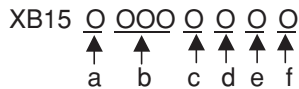

SYMBOL	DESCRIPTION	SYMBOL	DESCRIPTION
a	Development order (A...)	c	Version
b	Series :	d	Lead length :
	105		0 : No lead
	204		1 : Short lead (26mm)
	301		2 : Long lead (52mm)
	303	e	Package type :
	308		G : Glass shield
	402		H : Ceramic (no lead)
	407	f	Taping method :
	709		B : Bag
			T : Paper tape
			R : Embossed tape (no lead)

Note : With the 26mm width, only the XB15A105, XB15A204 and XB15A301 are available in the taping format. Please further note that the XB15A105 has a 'Minimum Order Unit' of 5000 pcs./ Box and not 2000.

Taping Specification

Axial Taping

