

2N5160

The RF Line

PNP SILICON RF POWER TRANSISTOR

... designed for amplifier, frequency multiplier or oscillator applications in military and industrial equipment. Suitable for use as Class A, B, or C output driver, or pre-driver stages in VHF and UHF.

- High Power Gain — $G_{pE} = 8.0$ dB (Min) ($\alpha f = 400$ MHz, 14.5 dB (Typ) ($\alpha f = 175$ MHz — No Emitter Tuning
- Power Output — $P_{out} = 1.0$ Watt (Min ($\alpha f = 400$ MHz = 1.5 Watt (Typ) ($\alpha f = 175$ MHz
- Resists Burnout When Load is Shorted or Opened
- Designed for Use in Complementary Circuits with 2N3866
- MIL-S-19500 Processed Versions Available as MRF5160HX, MRF5160HXV

$I_C = -400$ mA
POWER TRANSISTOR
PNP SILICON

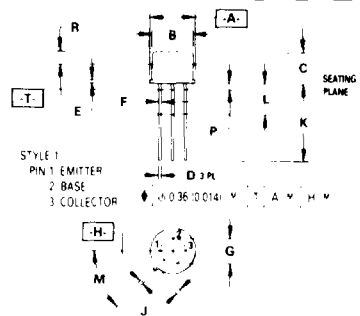
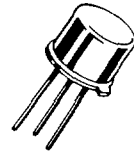

NOTES

1. DIMENSIONING AND TOLERANCING PER ANSI Y14.5M-1982
2. CONTROLLING DIMENSION INCH
3. DIMENSION J MEASURED FROM DIMENSION A MAXIMUM
4. DIMENSION B SHALL NOT VARY MORE THAN 0.25 (0.010) IN ZONE R. THIS ZONE CONTROLLED FOR AUTOMATIC HANDLING
5. DIMENSION F APPLIES BETWEEN DIMENSION P AND L. DIMENSION D APPLIES BETWEEN DIMENSION L AND K. MINIMUM LEAD DIAMETER IS UNCONTROLLED IN DIMENSION P AND BEYOND DIMENSION K. MINIMUM

DIM	MILLIMETERS		INCHES	
	MIN	MAX	MIN	MAX
A	8.51	9.39	0.335	0.370
B	7.75	8.50	0.305	0.335
C	6.10	6.60	0.240	0.260
D	0.41	0.53	0.016	0.021
E	0.23	1.04	0.009	0.041
F	0.41	0.48	0.016	0.019
G	9.08 BSC		0.200 BSC	
H	0.72	0.86	0.028	0.034
J	0.74	1.14	0.029	0.045
K	12.70	19.25	0.500	0.750
L	6.35		0.250	
M	45 BSC		45 BSC	
P	1.27		0.050	
R	2.54		0.100	

CASE 79-04
TO-205AD
(TO-39)

***MAXIMUM RATINGS**

Rating	Symbol	Value	Unit
Collector-Emitter Voltage	V_{CEO}	- 40	Vdc
Collector-Base Voltage	V_{CB}	60	Vdc
Emitter-Base Voltage	V_{EB}	4.0	Vdc
Collector Current	I_C	0.4	Adc
Total Device Dissipation ($T_C = 25^\circ\text{C}$ Derate above 25°C)	P_D	5.0 28.6	Watts mW/°C
Operating and Storage Junction Temperature Range	T_J, T_{stg}	65 to +200	°C

*Indicates JEDEC Registered Data.

2N5160

*ELECTRICAL CHARACTERISTICS (T_A = 25°C unless otherwise noted)

Characteristic	Symbol	Min	Typ	Max	Unit
OFF CHARACTERISTICS					
Collector-Emitter Sustaining Voltage (I _C = 5.0 mA, I _B = 0)	V _{CEO(sus)}	40	—	—	Vdc
Emitter-Base Breakdown Voltage (I _E = -0.1 mA, I _C = 0)	V _{(BR)EBO(sus)}	4.0	—	—	Vdc
Collector Cutoff Current (V _{CE} = -28 Vdc, I _B = 0)	I _{CEO}	—	—	20	μA
Collector Cutoff Current (V _{CE} = 60 Vdc, V _{BE} = 0)	I _{CES}	—	—	0.1	mA
Collector Cutoff Current (V _{CB} = 28 Vdc, I _E = 0)	I _{CBO}	—	—	1.0	μA
ON CHARACTERISTICS					
DC Current Gain (I _C = 50 mA, V _{CE} = 5.0 Vdc)	h _{FE}	10	—	—	—
DYNAMIC CHARACTERISTICS					
Current-Gain — Bandwidth Product (I _C = 50 mA, V _{CE} = 15 Vdc, f = 200 MHz)	f _T	500	900	—	MHz
Collector-Base Capacitance (V _{CB} = 28 Vdc, I _E = 0, f = 0.1 to 1.0 MHz)	C _{cb}	—	2.5	4.0	pF
FUNCTIONAL TESTS					
Common-Emitter Amplifier Power Gain (V _{CE} = 28 Vdc, P _{in} = 0.16 Watt, f = 400 MHz) (V _{CE} = 28 Vdc, P _{in} = 50 mW, f = 175 MHz)	G _{PE}	8.0 —	8.8 14.5	— —	dB
Power Output (V _{CE} = 28 Vdc, P _{in} = 0.16 Watt, f = 400 MHz) (V _{CE} = 28 Vdc, P _{in} = 50 mW, f = 175 MHz)	P _{out}	1.0 —	1.2 1.4	— —	Watt
Collector Efficiency (V _{CE} = 28 Vdc, P _{in} = 0.16 Watt, f = 400 MHz)	η	45	55	—	%

*Indicates JEDEC Registered Data

FIGURE 1 — 400-MHz TEST CIRCUIT

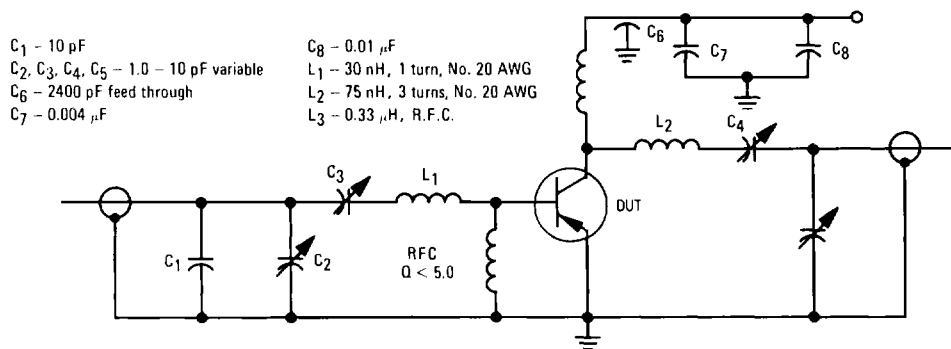

2

FIGURE 2 — POWER OUTPUT versus FREQUENCY

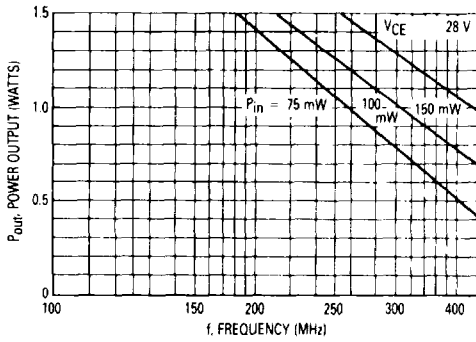

FIGURE 3 — POWER OUTPUT versus POWER INPUT

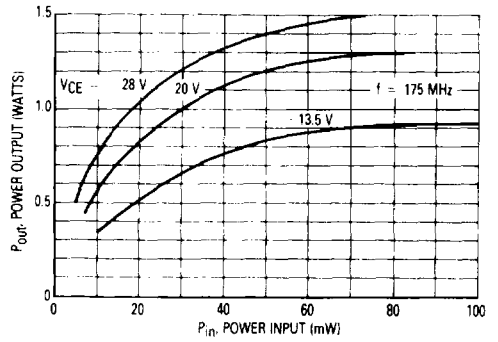

FIGURE 4 — PARALLEL INPUT IMPEDANCE versus FREQUENCY

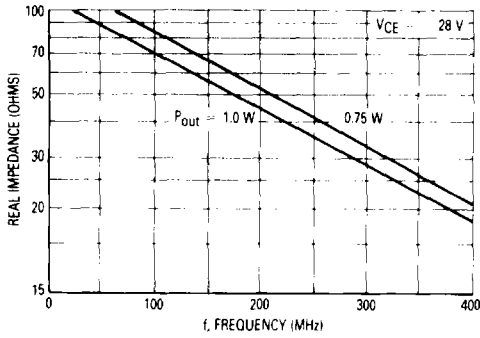

FIGURE 5 — PARALLEL INPUT IMPEDANCE versus FREQUENCY

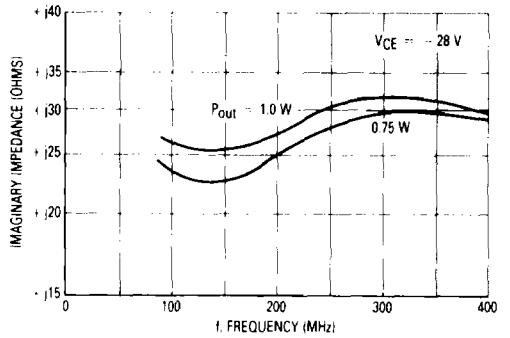

FIGURE 6 — PARALLEL OUTPUT CAPACITANCE versus FREQUENCY

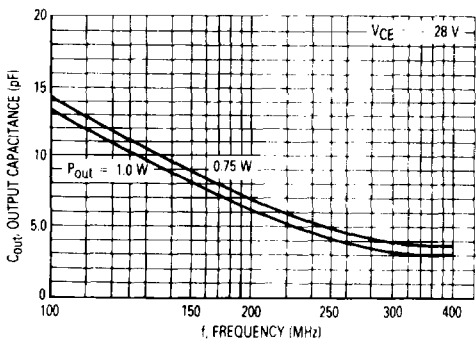
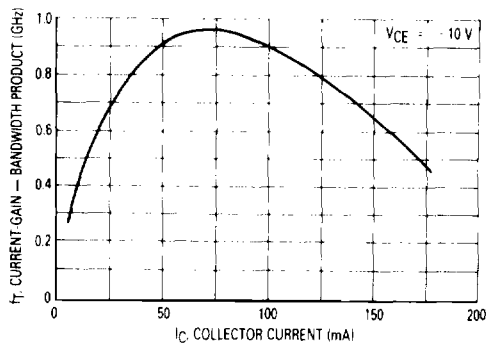
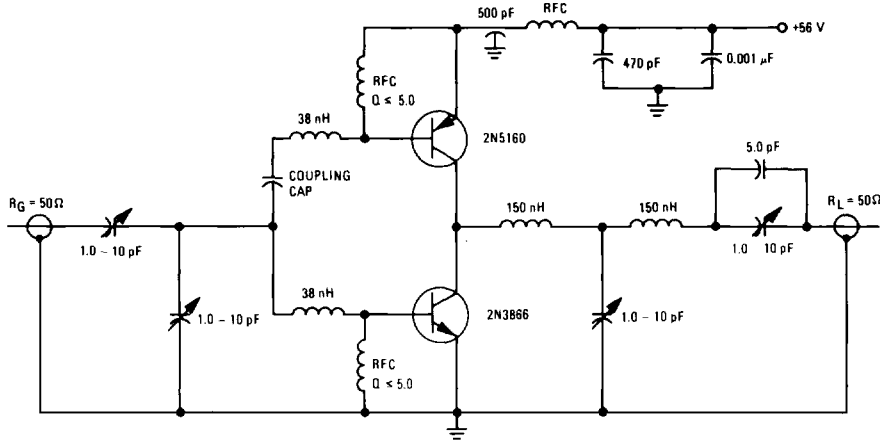

FIGURE 7 — CURRENT-GAIN — BANDWIDTH PRODUCT versus COLLECTOR CURRENT



2N5160

FIGURE 8 – 2N5160 300-MHz COMPLEMENTARY POWER OUTPUT CIRCUIT



2

FIGURE 9 – COMPLEMENTARY CIRCUIT – POWER OUTPUT versus POWER INPUT

